

Small Signal MOSFET

115 mAmps, 60 Volts

N-Channel SOT-23

- We declare that the material of product compliance with RoHS requirements.

MAXIMUM RATINGS

Rating	Symbol	Value	Unit
Drain-Source Voltage	V_{DSS}	60	V _{dc}
Drain-Gate Voltage ($R_{GS} = 1.0 \text{ M}\Omega$)	V_{DGR}	60	V _{dc}
Drain Current	I_D	± 115	mAdc
– Continuous $T_C = 25^\circ\text{C}$ (Note 1.)	I_D	± 75	
– Pulsed (Note 2.)	I_{DM}	± 800	
Gate-Source Voltage	V_{GS}	± 20	V _{dc}
– Continuous	V_{GSM}	± 40	V _{pk}
– Non-repetitive ($t_p \leq 50 \mu\text{s}$)			

THERMAL CHARACTERISTICS

Characteristic	Symbol	Max	Unit
Total Device Dissipation FR-5 Board (Note 3.) $T_A = 25^\circ\text{C}$ Derate above 25°C	P_D	225 1.8	mW mW/ $^\circ\text{C}$
Thermal Resistance, Junction to Ambient	$R_{\theta JA}$	556	$^\circ\text{C}/\text{W}$
Total Device Dissipation Alumina Substrate, (Note 4.) $T_A = 25^\circ\text{C}$ Derate above 25°C	P_D	300 2.4	mW mW/ $^\circ\text{C}$
Thermal Resistance, Junction to Ambient	$R_{\theta JA}$	417	$^\circ\text{C}/\text{W}$
Junction and Storage Temperature	T_J, T_{stg}	-55 to +150	$^\circ\text{C}$

1. The Power Dissipation of the package may result in a lower continuous drain current.
2. Pulse Test: Pulse Width $\leq 300 \mu\text{s}$, Duty Cycle $\leq 2.0\%$.
3. FR-5 = $1.0 \times 0.75 \times 0.062$ in.
4. Alumina = $0.4 \times 0.3 \times 0.025$ in 99.5% alumina.

ORDERING INFORMATION

Device	Marking	Shipping
L2N7002LT1G	702	3000 Tape & Reel
L2N7002LT3G	702	10000 Tape & Reel

L2N7002LT1G



115 mAmps
60 Volts
 $R_{DS(on)} = 7.5 \Omega$

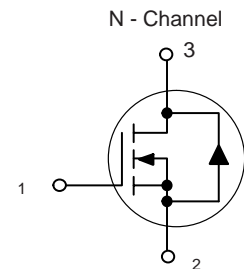

MARKING DIAGRAM & PIN ASSIGNMENT

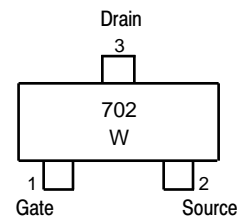

702 = Device Code
W = Work Week

L2N7002LT1G
ELECTRICAL CHARACTERISTICS ($T_A = 25^\circ\text{C}$ unless otherwise noted)

Characteristic	Symbol	Min	Typ	Max	Unit
OFF CHARACTERISTICS					
Drain–Source Breakdown Voltage ($V_{GS} = 0, I_D = 10 \mu\text{A}$)	$V_{(BR)DSS}$	60	–	–	Vdc
Zero Gate Voltage Drain Current ($V_{GS} = 0, V_{DS} = 60 \text{ Vdc}$)	I_{DSS}	– –	– –	1.0 500	μA
Gate–Body Leakage Current, Forward ($V_{GS} = 20 \text{ Vdc}$)	I_{GSSF}	–	–	100	nA
Gate–Body Leakage Current, Reverse ($V_{GS} = -20 \text{ Vdc}$)	I_{GSSR}	–	–	-100	nA

ON CHARACTERISTICS (Note 2.)

Gate Threshold Voltage ($V_{DS} = V_{GS}, I_D = 250 \mu\text{A}$)	$V_{GS(th)}$	1.0	1.6	2	Vdc
On–State Drain Current ($V_{DS} \geq 2.0 V_{DS(on)}, V_{GS} = 10 \text{ Vdc}$)	$I_{D(on)}$	500	–	–	mA
Static Drain–Source On–State Voltage ($V_{GS} = 10 \text{ Vdc}, I_D = 500 \text{ mA}$) ($V_{GS} = 5.0 \text{ Vdc}, I_D = 50 \text{ mA}$)	$V_{DS(on)}$	– –	– –	3.75 0.375	Vdc
Static Drain–Source On–State Resistance ($V_{GS} = 10 \text{ V}, I_D = 500 \text{ mA}$) $T_C = 25^\circ\text{C}$ $T_C = 125^\circ\text{C}$ ($V_{GS} = 5.0 \text{ Vdc}, I_D = 50 \text{ mA}$) $T_C = 25^\circ\text{C}$ $T_C = 125^\circ\text{C}$	$r_{DS(on)}$	– – – –	1.4 – 1.8 –	7.5 13.5 7.5 13.5	Ohms
Forward Transconductance ($V_{DS} \geq 2.0 V_{DS(on)}, I_D = 200 \text{ mA}$)	g_{FS}	80	–	–	mmhos

DYNAMIC CHARACTERISTICS

Input Capacitance ($V_{DS} = 25 \text{ Vdc}, V_{GS} = 0, f = 1.0 \text{ MHz}$)	C_{iss}	–	17	50	pF
Output Capacitance ($V_{DS} = 25 \text{ Vdc}, V_{GS} = 0, f = 1.0 \text{ MHz}$)	C_{oss}	–	10	25	pF
Reverse Transfer Capacitance ($V_{DS} = 25 \text{ Vdc}, V_{GS} = 0, f = 1.0 \text{ MHz}$)	C_{rss}	–	2.5	5.0	pF

SWITCHING CHARACTERISTICS (Note 2.)

Turn–On Delay Time	($V_{DD} = 25 \text{ Vdc}, I_D \cong 500 \text{ mA}$, $R_G = 25 \Omega, R_L = 50 \Omega, V_{gen} = 10 \text{ V}$)	$t_{d(on)}$	–	7	20	ns
Turn–Off Delay Time		$t_{d(off)}$	–	11	40	ns

BODY–DRAIN DIODE RATINGS

Diode Forward On–Voltage ($I_S = 115 \text{ mA}, V_{GS} = 0 \text{ V}$)	V_{SD}	–	–	-1.5	Vdc
Source Current Continuous (Body Diode)	I_S	–	–	-115	mA
Source Current Pulsed	I_{SM}	–	–	-800	mA

 2. Pulse Test: Pulse Width $\leq 300 \mu\text{s}$, Duty Cycle $\leq 2.0\%$.

L2N7002LT1G

TYPICAL ELECTRICAL CHARACTERISTICS

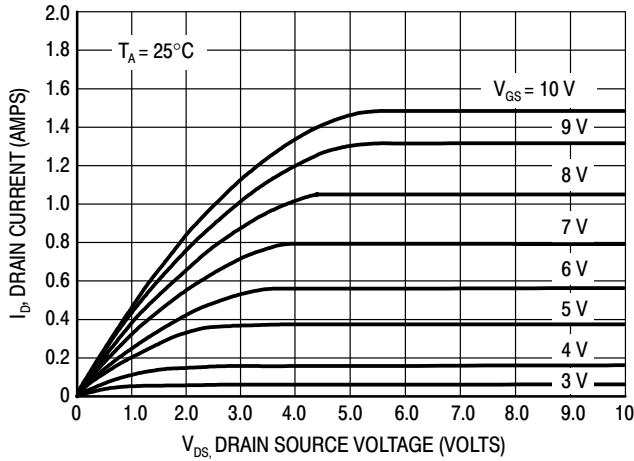

Figure 1. Ohmic Region

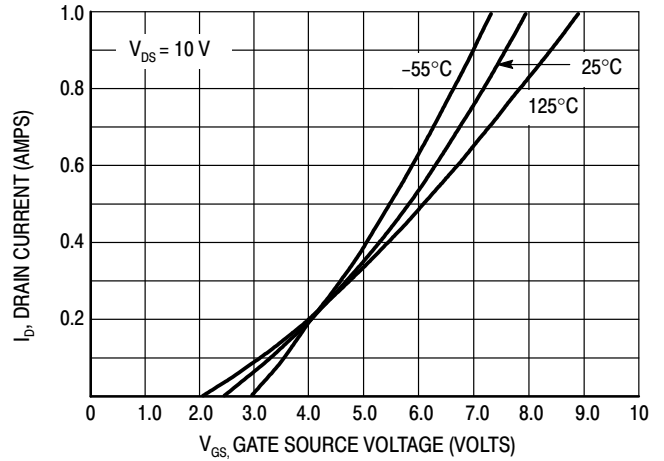

Figure 2. Transfer Characteristics

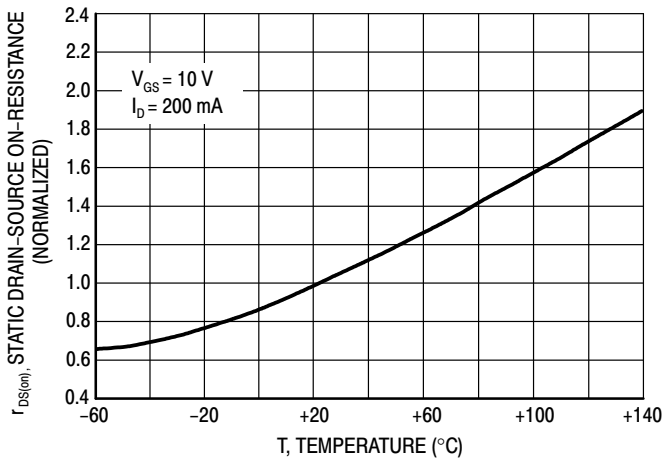

Figure 3. Temperature versus Static Drain-Source On-Resistance

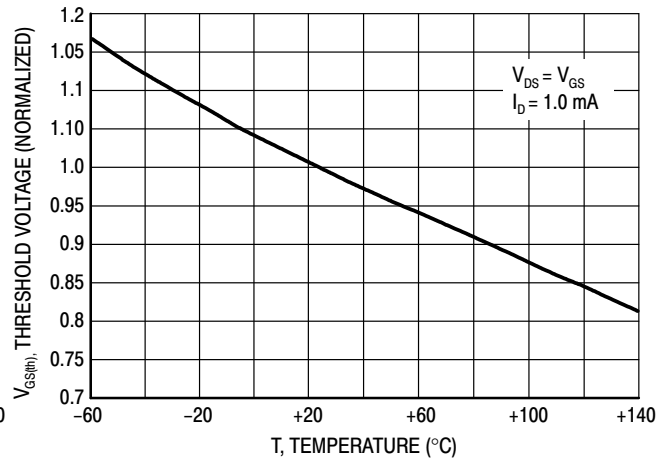
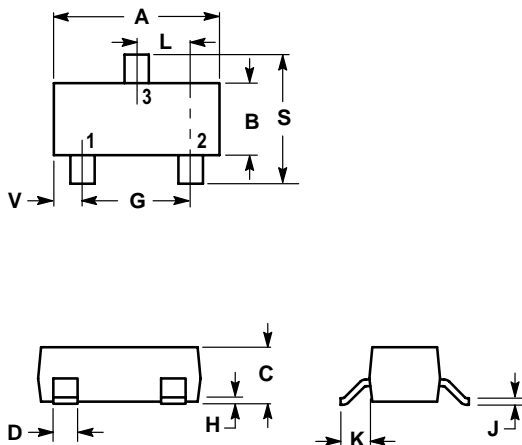

Figure 4. Temperature versus Gate Threshold Voltage

L2N7002LT1G
SOT-23
NOTES:

1. DIMENSIONING AND TOLERANCING PER ANSI Y14.5M,1982
2. CONTROLLING DIMENSION: INCH.



DIM	INCHES		MILLIMETERS	
	MIN	MAX	MIN	MAX
A	0.1102	0.1197	2.80	3.04
B	0.0472	0.0551	1.20	1.40
C	0.0350	0.0440	0.89	1.11
D	0.0150	0.0200	0.37	0.50
G	0.0701	0.0807	1.78	2.04
H	0.0005	0.0040	0.013	0.100
J	0.0034	0.0070	0.085	0.177
K	0.0140	0.0285	0.35	0.69
L	0.0350	0.0401	0.89	1.02
S	0.0830	0.1039	2.10	2.64
V	0.0177	0.0236	0.45	0.60

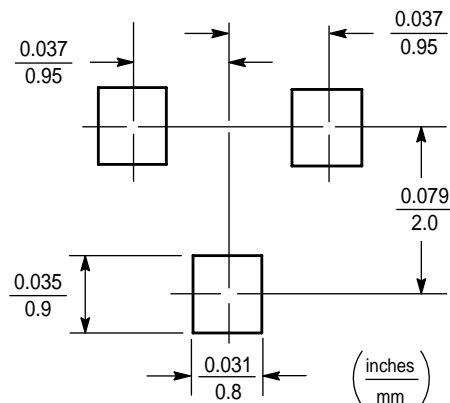

EMBOSSED TAPE AND REEL DATA FOR DISCRETES

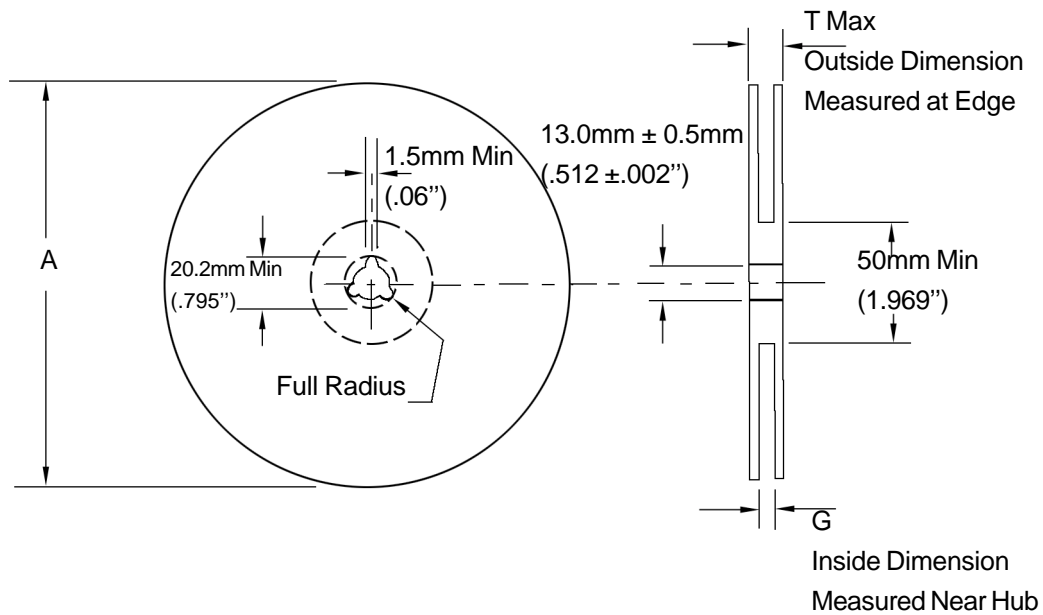

Size	A Max	G	T Max
8 mm	330mm (12.992")	8.4mm+1.5mm, -0.0 (.33"+.059", -0.00)	14.4mm (.56")

Reel Dimensions

Metric Dimensions Govern — English are in parentheses for reference only

Storage Conditions

Temperature: 5 to 40 Deg.C (20 to 30 Deg. C is preferred)

Humidity: 30 to 80 RH (40 to 60 is preferred)

Recommended Period: One year after manufacturing

(This recommended period is for the soldering condition only. The characteristics and reliabilities of the products are not restricted to this limitation)

Shipment Specification

