



DF005S thru DF10S

Miniature Glass Passivated Single-Phase Surface Mount Bridge Rectifiers
Reverse Voltage 50 to 1000 Volts Forward Current 1.0 Ampere

Features

- ◆ Ideal for printed circuit boards
- ◆ Applicable for automotive insertion
- ◆ High surge current capability
- ◆ Solder Dip 260 °C, 40 seconds

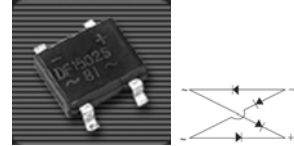

DFS

Mechanical Data

- ◆ Case: DFS
Epoxy meets UL-94V-0 Flammability rating
- ◆ Terminals: Matte tin plated (E3 Suffix) leads, solderable per J-STD-002B and JESD22-B102D
- ◆ Polarity: As marked on body

Typical Applications

General purpose use in ac-to-dc bridge full wave rectification for SMPS, Lighting Ballaster, Adapter, Battery Charger, Home Appliances, Office Equipment, and Telecommunication applications

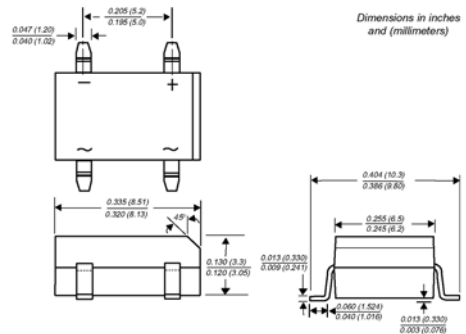

Maximum Ratings and Electrical Characteristics

($T_A=25^{\circ}\text{C}$ unless otherwise noted)

| Parameter | Symbols | DF005S DBS101 | DF01S DBS102 | DF02S DBS103 | DF04S DBS104 | DF06S DBS105 | DF08S DBS106 | DF10S DBS107 | Units |
|--|------------------------------------|------------------|-----------------|-----------------|-----------------|-----------------|-----------------|-----------------|-----------------------------|
| Maximum repetitive peak reverse voltage | V_{RRM} | 50 | 100 | 200 | 400 | 600 | 800 | 1000 | Volts |
| Maximum RMS voltage | V_{RMS} | 35 | 70 | 140 | 280 | 420 | 560 | 700 | Volts |
| Maximum DC blocking voltage | V_{DC} | 50 | 100 | 200 | 400 | 600 | 800 | 1000 | Volts |
| Maximum average forward output rectified current at $T_A=40^{\circ}\text{C}$ (Note 2) | $I_{F(AV)}$ | 1.0 | | | | | | | Amp |
| Peak forward surge current single half sine-wave superimposed on rated load (JEDEC Method) | I_{FSM} | 50.0 | | | | | | | Amps |
| Rating for fusing ($t < 8.3\text{ms}$) | I^2t | 10 | | | | | | | A^2sec |
| Maximum instantaneous forward voltage drop per leg at 0.5A | V_F | 1.1 | | | | | | | Volts |
| Maximum DC reverse current at rated DC blocking voltage per leg $T_A=25^{\circ}\text{C}$ $T_A=125^{\circ}\text{C}$ | I_R | 5.0 500 | | | | | | | μA |
| Typical junction capacitance per leg (Note 1) | C_j | 25 | | | | | | | pF |
| Typical thermal resistance per leg (Note 2) | $R_{\theta JA}$ $R_{\theta ML}$ | 40 15 | | | | | | | $^{\circ}\text{C}/\text{W}$ |
| Operating junction and storage temperature range | T_J, T_{STG} | -55 to +150 | | | | | | | $^{\circ}\text{C}$ |

- Notes:**
1. Measured at 1.0 MHz and applied reverse voltage of 4.0 Volts
 2. Units mounted on P.C.B. with 0.51 x 0.51" (13 x 13mm) copper pads

RATINGS AND CHARACTERISTIC CURVES

($T_A = 25^\circ\text{C}$ unless otherwise noted)

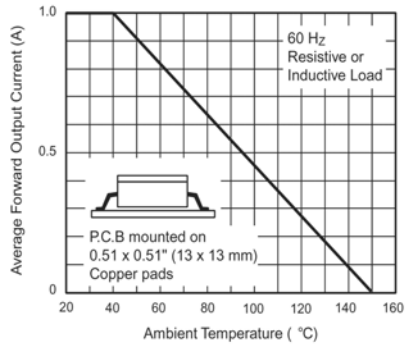

Figure 1. Derating Curve Output Rectified Current

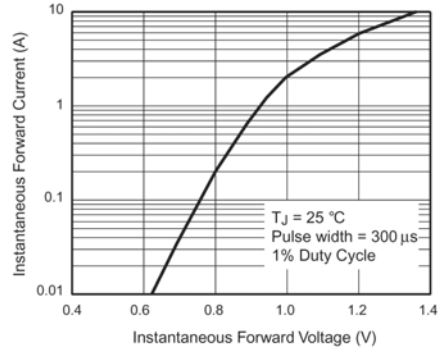

Figure 3. Typical Forward Characteristics Per Leg

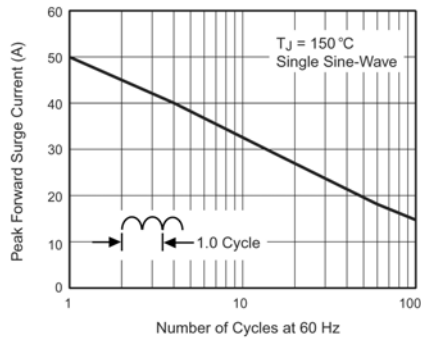

Figure 2. Maximum Non-Repetitive Peak Forward Surge Current Per Leg

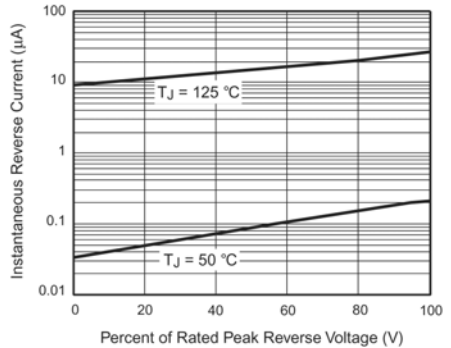

Figure 4. Typical Reverse Leakage Characteristics Per Leg

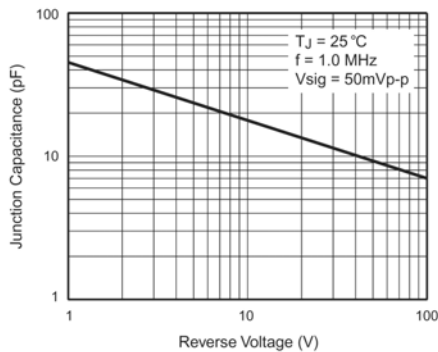

Figure 5. Typical Junction Capacitance Per Leg

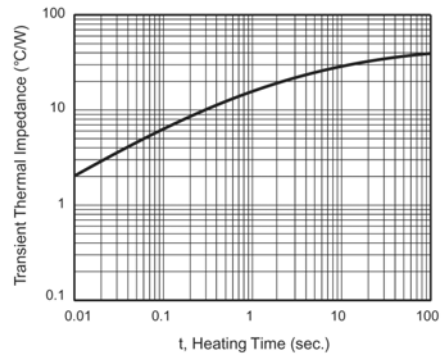

Figure 6. Typical Transient Thermal Impedance