

**HL7838G****GaAlAs LD***T-41-05***Description**

The HL7838G is a 0.78  $\mu\text{m}$  band GaAlAs laser diode with a double heterojunction structure and is appropriate as the light source for various optical application devices, including laser beam printers and laser levellers.

**Features**

- Visible light output:  $\lambda_p = 770$  to 795 nm
- High output: 20 mW in standard continuous operation, and 30 mW in pulsed operation.
- Built-in monitor photodiode
- Single longitudinal mode lasing

**Absolute Maximum Ratings ( $T_C = 25^\circ\text{C}$ )**

| Item                       | Symbol                | Rated Value | Units            |
|----------------------------|-----------------------|-------------|------------------|
| Optical output power       | $P_O$                 | 20          | mW               |
| Pulse optical output power | $P_{O(\text{pulse})}$ | 30*         | mW               |
| LD reverse voltage         | $V_R(\text{LD})$      | 2           | V                |
| PD reverse voltage         | $V_R(\text{PD})$      | 30          | V                |
| Operating temperature      | $T_{\text{opr}}$      | -10 to +60  | $^\circ\text{C}$ |
| Storage temperature        | $T_{\text{stg}}$      | -40 to +85  | $^\circ\text{C}$ |

\* At a duty cycle under 50% and pulse widths under 1 $\mu\text{s}$

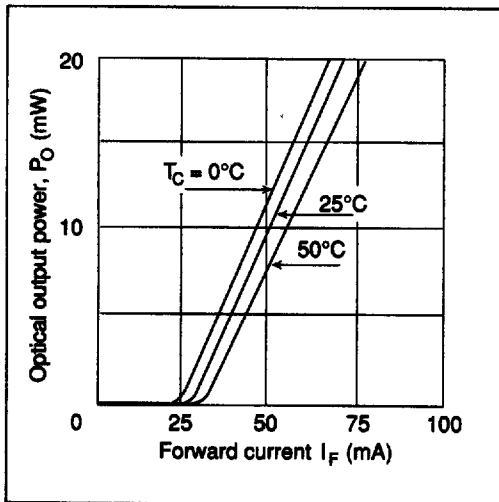
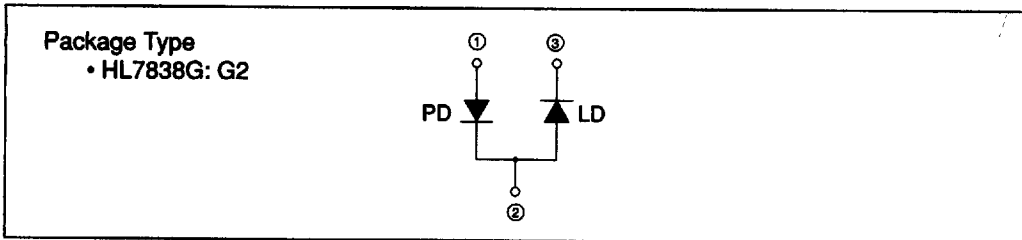
**Optical and Electrical Characteristics ( $T_C = 25^\circ\text{C}$ )**

| Item                            | Symbol               | Min | Typ  | Max | Units         | Test Conditions  |
|---------------------------------|----------------------|-----|------|-----|---------------|--|
| Threshold current               | $I_{\text{th}}$      | 20  | —    | 70  | mA            |  |
| Optical output power            | $P_O$                | 20  | —    | —   | mW            | Kink free  |
| Slope efficiency                | $\eta$               | 0.3 | 0.45 | —   | mW/mA         | $\frac{12 \text{ (mW)}}{I(16 \text{ mW}) - I(4 \text{ mW})}$ |
| Lasing wavelength               | $\lambda_p$          | 770 | 780  | 795 | nm            | $P_O = 20 \text{ mW}$  |
| Beam divergence (parallel)      | $\theta_{\parallel}$ | 8   | 10   | 14  | deg.          | $P_O = 20 \text{ mW}$  |
| Beam divergence (perpendicular) | $\theta_{\perp}$     | 20  | 26   | 35  | deg.          | $P_O = 20 \text{ mW}$  |
| Monitor current                 | $I_S$                | 30  | —    | —   | $\mu\text{A}$ | $V_R(\text{PD}) = 5 \text{ V}$<br>$P_O = 2 \text{ mW}$       |

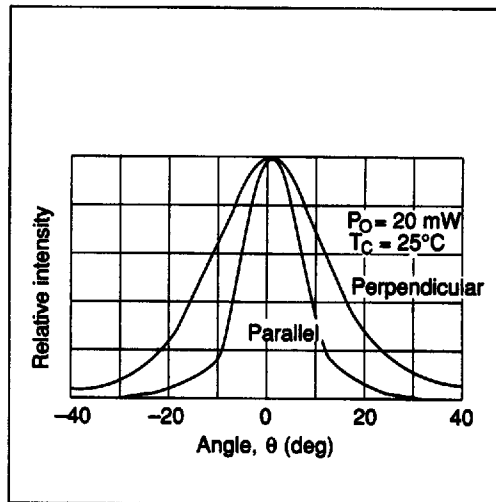
**HL7838G**

**Internal Circuit**

T-41-05

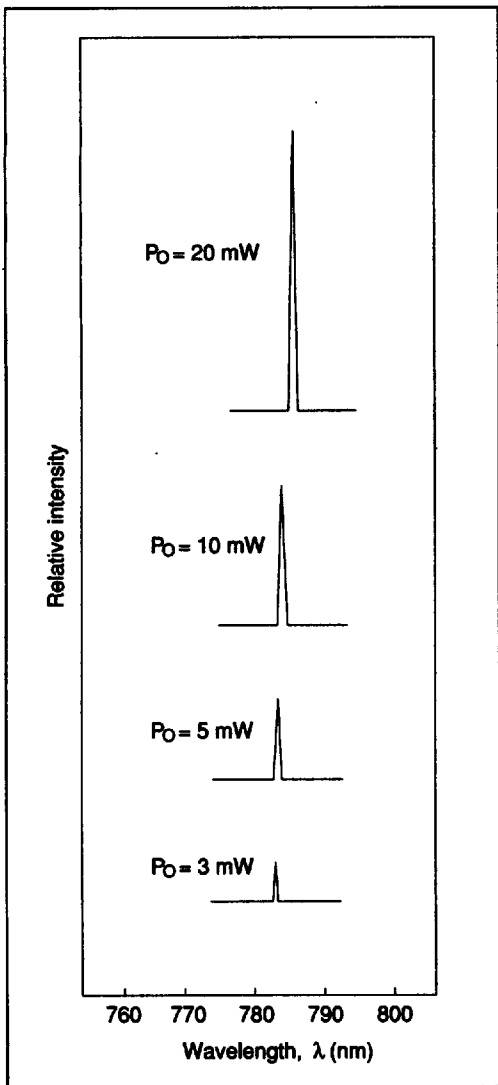


**Figure 1 Optical Output Power vs. Forward Current**

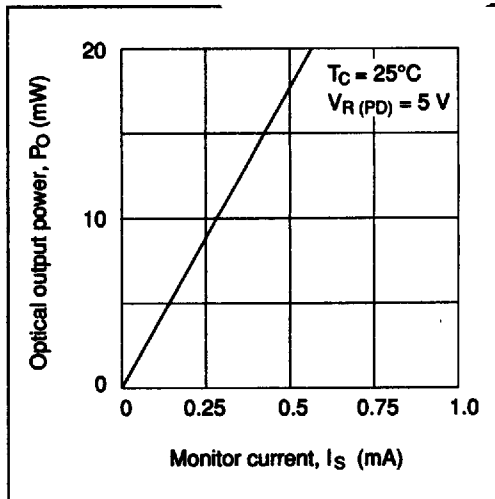


**Figure 2 Far Field Pattern**

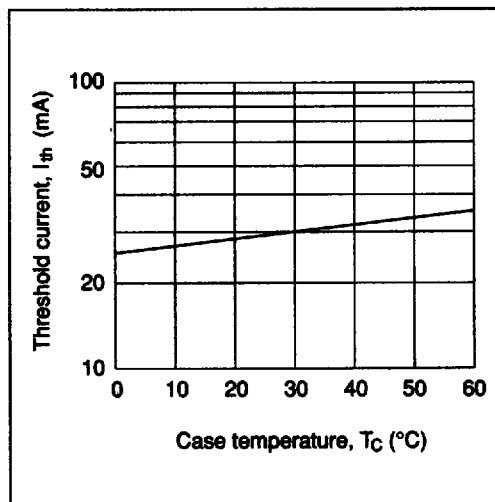
T-41-05



**Figure 3 Lasing Spectrum**



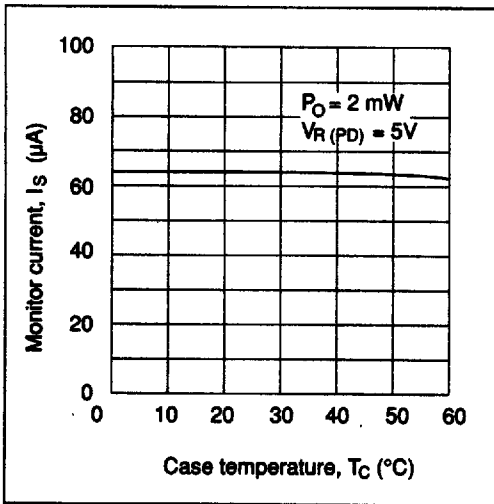
**Figure 4 Optical Output Power vs. Monitor Current**



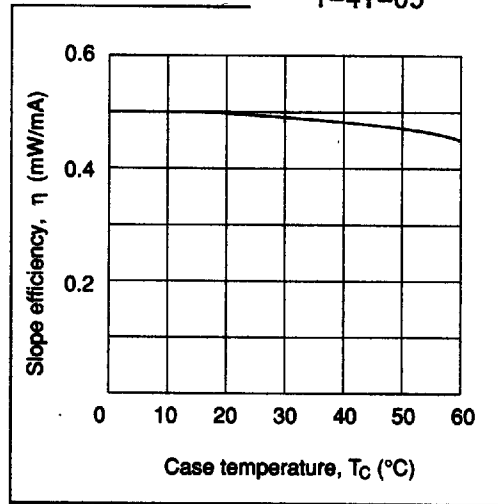
**Figure 5 Threshold Current vs. Case Temperature**

**HL7838G**

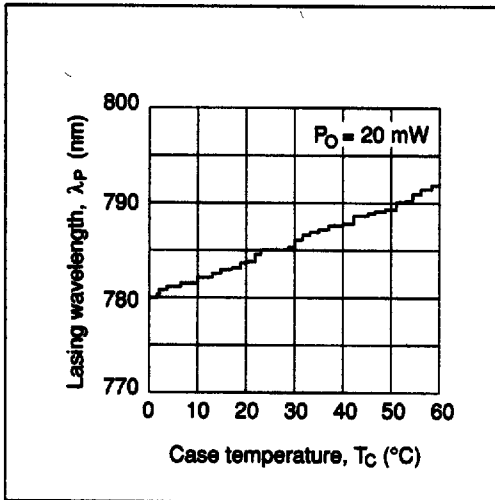
T-41-05



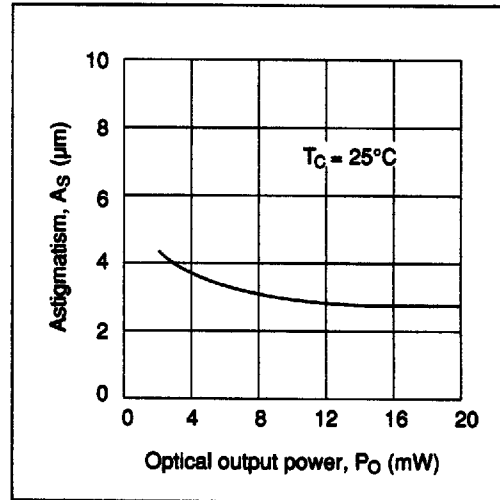
**Figure 6 Monitor Current vs. Case Temperature**



**Figure 7 Slope Efficiency vs. Case Temperature**

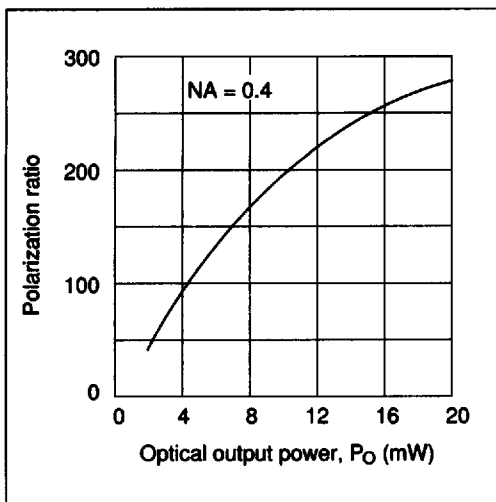


**Figure 8 Lasing Wavelength vs. Case Temperature**



**Figure 9 Astigmatism vs. Optical Output Power**

T-41-05



**Figure 10 Polarization Ratio vs. Optical Output Power**

## Section 6 Reliability

This section covers points which particularly affect the operating life light emitting devices, and provides some examples which should be studied before proceeding with your system design.

### 6.1 Characteristic Drift

When optical emission devices such as the LD or IRED are operated in the forward mode, crystal defects (point defects and dislocations) propagate in the active region of the crystal.

These crystal defects cause optical emission characteristics (optical output power, threshold current, etc.) to drift, and ultimately lead to the end of the device's useful operating life.

Figure 6-1 shows an example of drift in the optical output power vs current characteristic of a LD. From  $t_1$  to  $t_4$ , the threshold current increases and the slope efficiency declines. The end of useful operating life is defined as the point where the operating current becomes 1.5 times of its initial value.

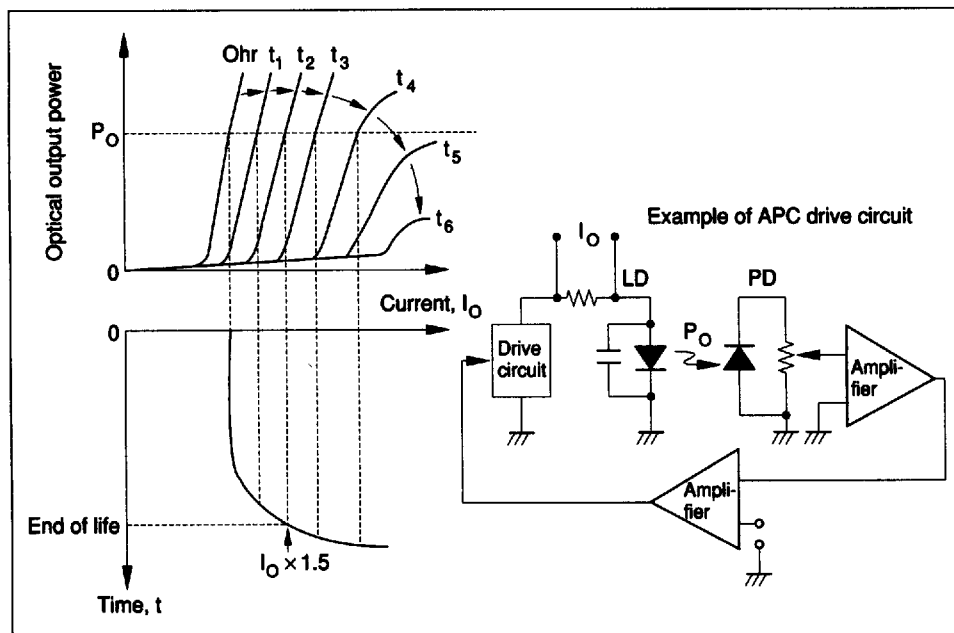


Figure 6-1 Example of Drift in LD Optical Output Power vs. Current Characteristic

## 6.2 Derating

T-90-40

LDs and IREs have a strong temperature dependence of lifetime. Thus, the expected operating life shows an exponential decrease with operating temperature. Derating should be employed to keep the rise of junction temperature as small as possible. (See figure 6-2, and 6-3). Figure 6-4 shows the dependence of operating life on optical output power. Please note that this decrease in operating life occurs even at threshold current bias.

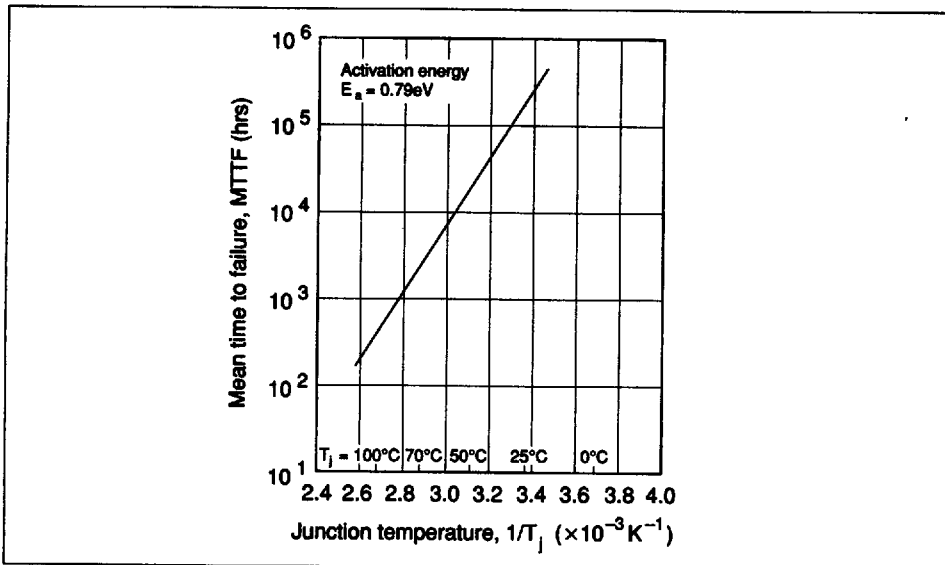


Figure 6-2 LD Mean Time to Failure vs. Junction Temperature (Example)

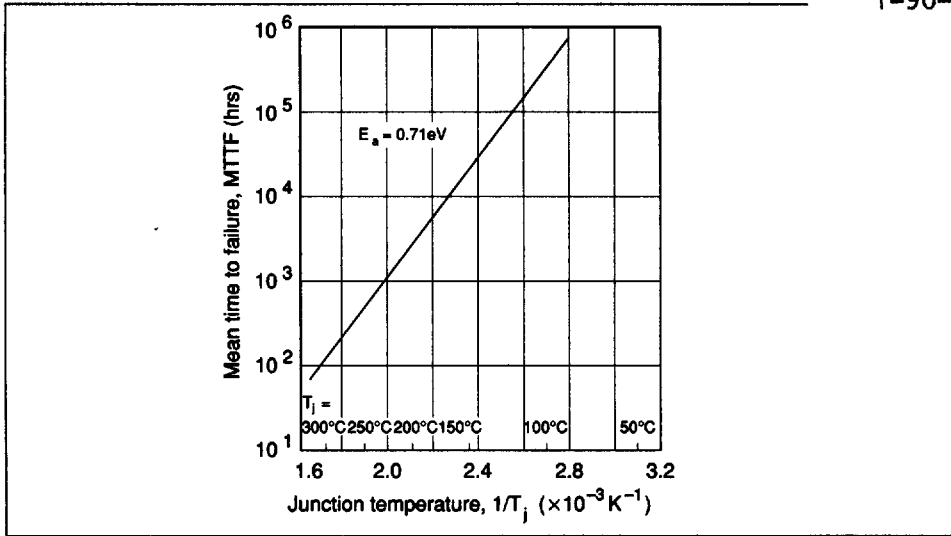


Figure 6-3 IRED Mean Time to Failure vs. Junction Temperature (Example)

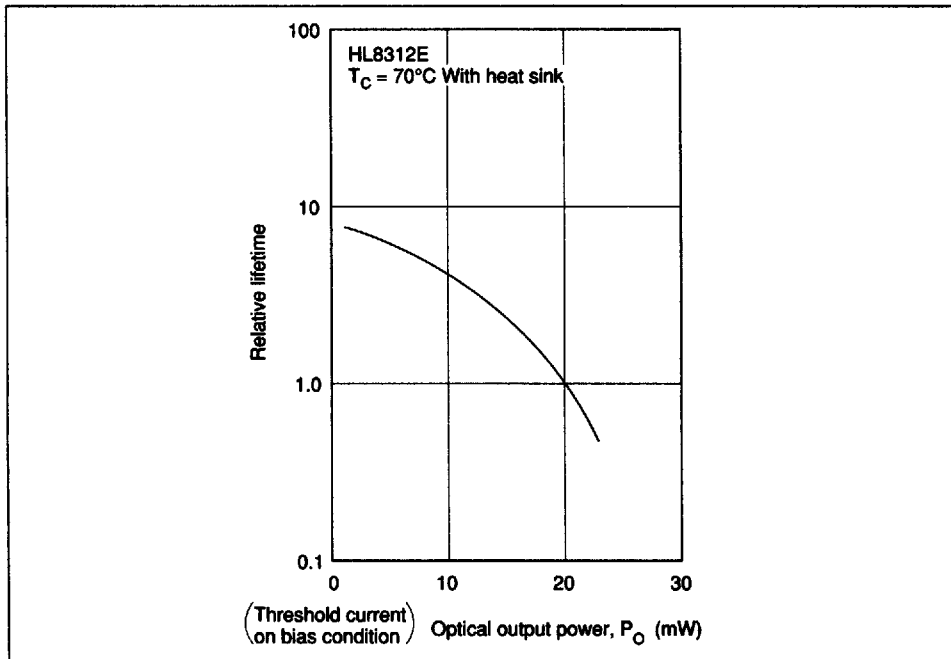


Figure 6-4 LD Operating Life vs. Optical Output Power (Example)



Figure 6-5 shows operating current dependence of IRED lifetime. In particular, when operated in open air at high current, the operating life is drastically affected by the rise in junction temperature due to heat generated by the device. Careful attention must be paid to carrying away excess heat.

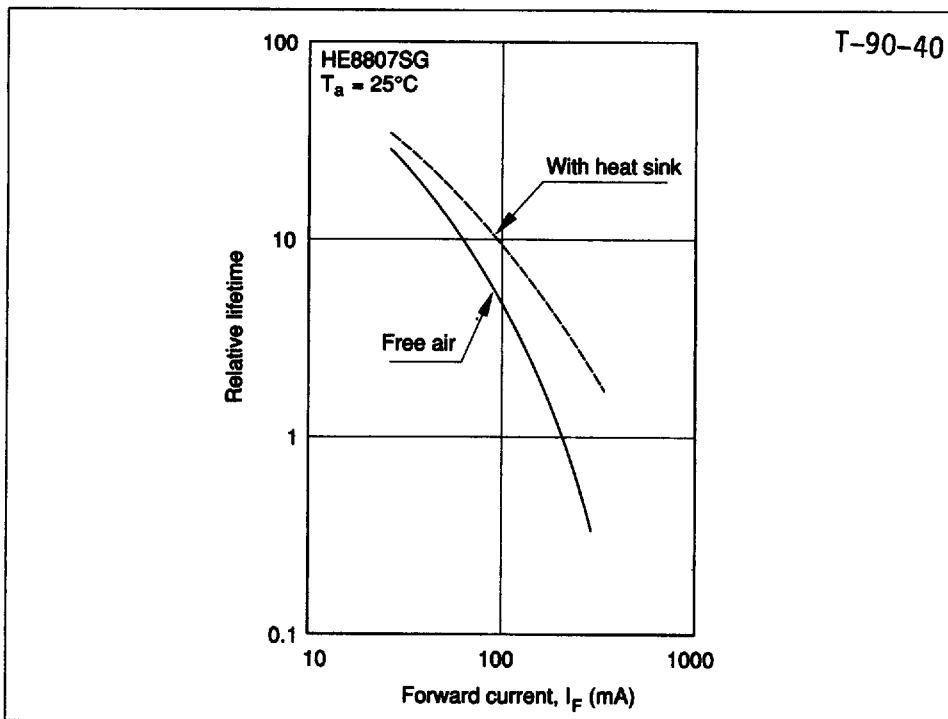


Figure 6-5 IRED Operating Life vs. Forward Current (Example)

### 6.3 Estimation for Useful Operating Life

The operating life of light emitting devices exhibits the typical wear failure distribution, and thus is generally approximated by the lognormal distribution. Figure 6-6 shows an example distribution for LD operating life. When the temperature derating and optical output power derating discussed in the previous section are also considered, the actual expected operating life under given operating conditions can be estimated.

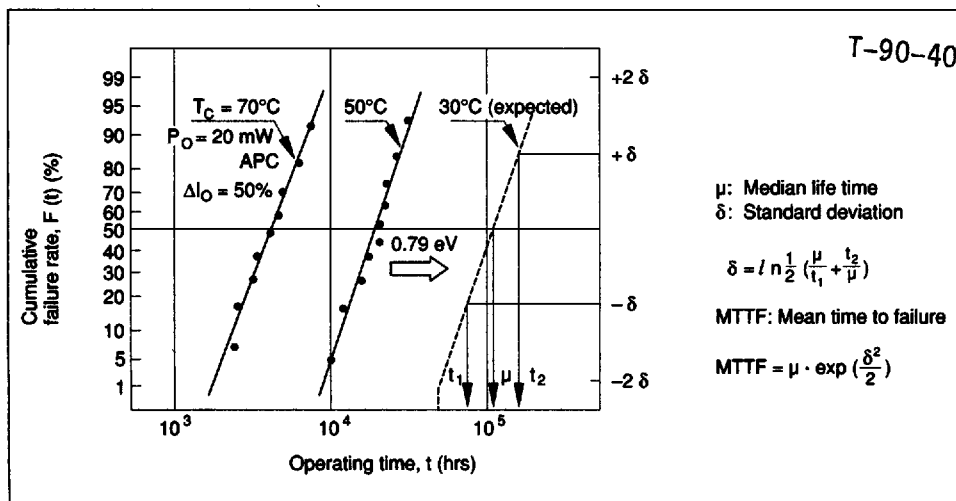


Figure 6-6 Distribution of Expected LD Life (Example)

### 6.4 Standard Devices Graded by Expected Life

Hitachi classifies IREDs of standard-specifications by life levels and applications as shown in table 6-1. For special requests or further details, please see your Hitachi representative.

Table 6-1 Lifetime and Application for Standard-specification IREDs

| Applications               | Expected Life Time | Operating Conditions                                      | Criteria                                   | Applicable Products                                    |
|----------------------------|--------------------|---|--|--|
| Auto-focusing still camera | 10 hrs.            | $I_F = 200 \text{ mA}$                                    | $F(t) = 0.1\%$ ,<br>$\Delta P_O \leq 30\%$ | HE8815VG<br>HE8813VG                                   |
| Auto-focusing VTR camera   | 200 hrs.           | $I_F = 250 \text{ mA}$<br>$f = 10 \text{ kHz}$ , duty 25% | $F(t) = 0.1\%$ ,<br>$\Delta P_O \leq 30\%$ | HE8815VG   |
| Measurement or general use | 1000 hrs.          | $T_J \leq P_O$ 100°C                                      | $F(t) = 0.1\%$ ,<br>$\Delta P_O \leq 30\%$ | HLP series,<br>HE8811, HE8812SG,<br>HE8404SG, HE7601SG |
| Industrial use             | 10000 hrs.         | $T_J \leq 100^\circ\text{C}$                              | $F(t) = 1\%$ ,<br>$\Delta P_O \leq 50\%$   | HE8807 series  |
| Communications use         | 24000 hrs.         | $T_J \leq 100^\circ\text{C}$                              | $F(t) = 1\%$ ,<br>$\Delta P_O \leq 50\%$   | HE8403 series,<br>HE1301 series                        |