

MIW1000 Series

2~3W, Wide Input Range DIP, Single & Dual Output DC/DC Converters



Key Features



- Efficiency up to 84%
- 1500VDC Isolation
- MTBF > 1,000,000 Hours
- 2:1 Wide Input Range
- UL60950-1 Safety Approval
- Low Cost
- Temperature Performance -25°C to +71°C
- Industry Standard Pinout
- UL 94V-0 Package Material
- Internal SMD Construction

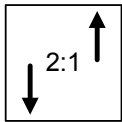

Wide Range

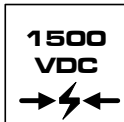

I/O Isolation

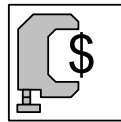

Low Cost

Minmax's MIW1000-Series power modules are low-profile dc-dc converters that operate over input voltage ranges of 4.5-9VDC, 9-18VDC, 18-36VDC and 36-72VDC which provide precisely regulated output voltages of 3.3V, 5V, 12V, 15V, $\pm 5V$, $\pm 12V$ and $\pm 15VDC$.

The -25°C to +71°C operating temperature range makes it ideal for data communication equipments, mobile battery driven equipments, distributed power systems, telecommunication equipments, mixed analog/digital subsystems, process/machine control equipments, computer peripheral systems and industrial robot systems.

The modules have a maximum power rating of 3W and a typical full-load efficiency of 84%, continuous short circuit, 45mV output ripple, built-in filtering for both input and output minimize the need for external filtering.

Absolute Maximum Ratings

Parameter	Min.	Max.	Unit	
Input Surge Voltage (1000 mS)	5VDC Input Models	-0.7	11	VDC
	12VDC Input Models	-0.7	25	VDC
	24VDC Input Models	-0.7	50	VDC
	48VDC Input Models	-0.7	100	VDC
Lead Temperature (1.5mm from case for 10 Sec.)	---	260	°C	
Internal Power Dissipation	---	2,500	mW	

Exceeding the absolute maximum ratings of the unit could cause damage. These are not continuous operating ratings.

Environmental Specifications

Parameter	Conditions	Min.	Max.	Unit
Operating Temperature	Ambient	-25	+71	°C
Operating Temperature	Case	-25	+90	°C
Storage Temperature		-40	+125	°C
Humidity		---	95	%
Cooling	Free-Air Convection			

Model Selection Guide

Model Number	Input Voltage	Output Voltage	Output Current		Input Current		Reflected Ripple Current	Efficiency
			Max.	Min.	@Max. Load	@No Load		@Max. Load
	VDC	VDC	mA	mA	mA (Typ.)	mA (Typ.)	mA (Typ.)	% (Typ.)
MIW1011	5 (4.5 ~ 9)	3.3	600	60	566	40	100	70
MIW1012		5	500	50	685			73
MIW1013		12	250	25	779			77
MIW1014		15	200	20	779			77
MIW1015		±5	±250	±25	694			72
MIW1016		±12	±125	±12.5	800			75
MIW1017		±15	±100	±10	800			75
MIW1021	12 (9 ~ 18)	3.3	600	60	223	20	30	74
MIW1022		5	500	50	267			78
MIW1023		12	250	25	305			82
MIW1024		15	200	20	305			82
MIW1025		±5	±250	±25	271			77
MIW1026		±12	±125	±12.5	313			80
MIW1027		±15	±100	±10	313			80
MIW1031	24 (18 ~ 36)	3.3	600	60	109	5	15	76
MIW1032		5	500	50	132			79
MIW1033		12	250	25	149			84
MIW1034		15	200	20	149			84
MIW1035		±5	±250	±25	132			79
MIW1036		±12	±125	±12.5	152			82
MIW1037		±15	±100	±10	152			82
MIW1041	48 (36 ~ 72)	3.3	600	60	55	3	10	76
MIW1042		5	500	50	66			79
MIW1043		12	250	25	75			84
MIW1044		15	200	20	75			84
MIW1045		±5	±250	±25	65			80
MIW1046		±12	±125	±12.5	75			84
MIW1047		±15	±100	±10	75			84

Capacitive Load

Models by Vout	3.3V	5V	12V	15V	±5V #	±12V #	±15V #	Unit
Maximum Capacitive Load	4000	4000	4000	4000	1000	1000	1000	µF

For each output

Input Fuse Selection Guide

5V Input Models	12V Input Models	24V Input Models	48V Input Models
1500mA Slow – Blow Type	700mA Slow – Blow Type	350mA Slow – Blow Type	135mA Slow – Blow Type

MIW1000 Series

Input Specifications

Parameter	Model	Min.	Typ.	Max.	Unit
Start Voltage	5V Input Models	3.5	4	4.5	VDC
	12V Input Models	4.5	7	9	
	24V Input Models	8	12	18	
	48V Input Models	16	24	36	
Under Voltage Shutdown	5V Input Models	---	3.5	4	
	12V Input Models	---	6.5	8.5	
	24V Input Models	---	11	17	
	48V Input Models	---	22	34	
Reverse Polarity Input Current	All Models	---	---	1	A
Short Circuit Input Power		---	1000	2000	mW
Input Filter		Pi Filter			

Output Specifications

Parameter	Conditions	Min.	Typ.	Max.	Unit
Output Voltage Accuracy		---	± 0.5	± 1.0	%
Output Voltage Balance	Dual Output, Balanced Loads	---	± 0.5	± 2.0	%
Line Regulation	Vin=Min. to Max.	---	± 0.2	± 0.5	%
Load Regulation	Io=10% to 100%	---	± 0.2	± 0.5	%
Ripple & Noise (20MHz)		---	45	60	mV P-P
Ripple & Noise (20MHz)	Over Line, Load & Temp.	---	---	100	mV P-P
Ripple & Noise (20MHz)		---	---	15	mV rms
Over Power Protection		120	---	---	%
Transient Recovery Time	50% Load Step Change	---	300	500	μ S
Transient Response Deviation		---	± 3	± 5	%
Temperature Coefficient		---	± 0.01	± 0.02	%/°C
Output Short Circuit	Continuous				

General Specifications

Parameter	Conditions	Min.	Typ.	Max.	Unit
Isolation Voltage Rated	60 Seconds	1500	---	---	VDC
Isolation Voltage Test	Flash Tested for 1 Second	1650	---	---	VDC
Isolation Resistance	500VDC	1000	---	---	M Ω
Isolation Capacitance	100KHz, 1V	---	65	100	pF
Switching Frequency		---	300	---	KHz
MTBF	MIL-HDBK-217F @ 25°C, Ground Benign	1000	---	---	K Hours

Notes :

- Specifications typical at Ta=+25°C, resistive load, nominal input voltage, rated output current unless otherwise noted.
- Transient recovery time is measured to within 1% error band for a step change in output load of 50% to 100%.
- Ripple & Noise measurement bandwidth is 0–20 MHz.
- These power converters require a minimum output loading to maintain specified regulation.
- Operation under no-load conditions will not damage these modules; however, they may not meet all specifications listed.
- All DC/DC converters should be externally fused at the front end for protection.
- Other input and output voltage may be available, please contact factory.
- Specifications subject to change without notice.

Block Diagram

Single Output

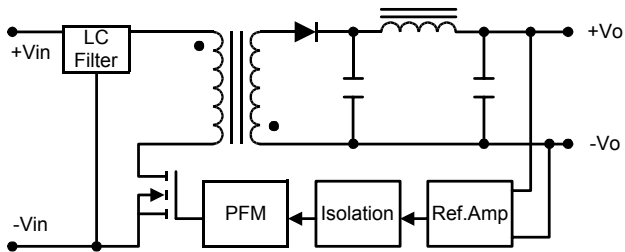

Dual Output

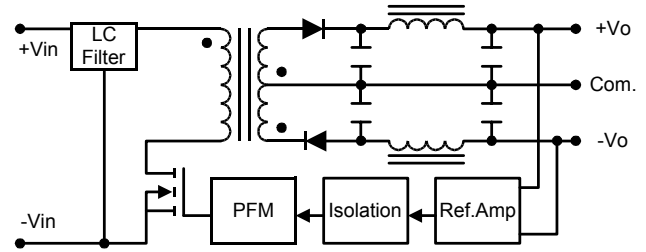

Input Voltage Transient Rating

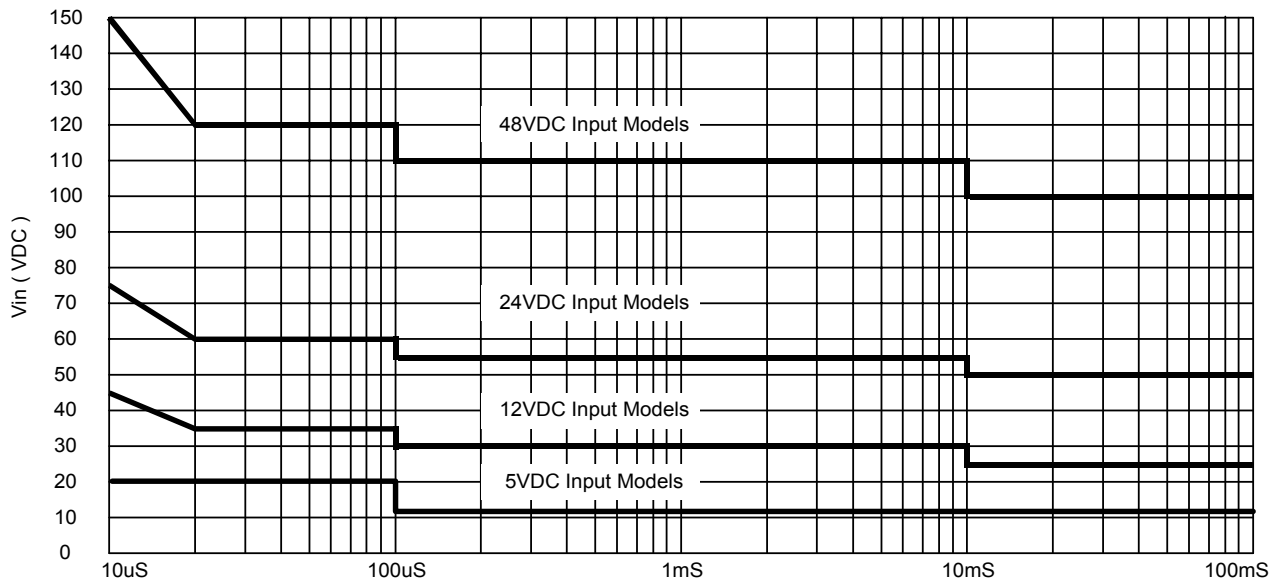

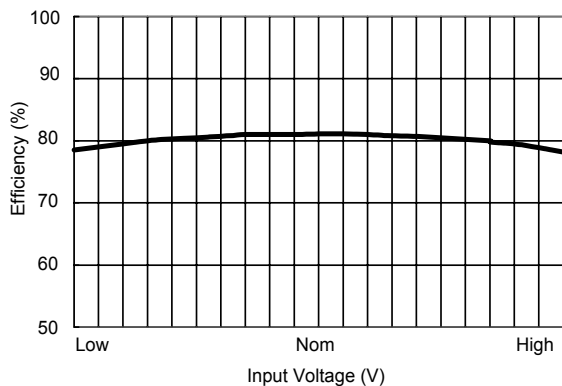

Efficiency vs Input Voltage (Single Output)

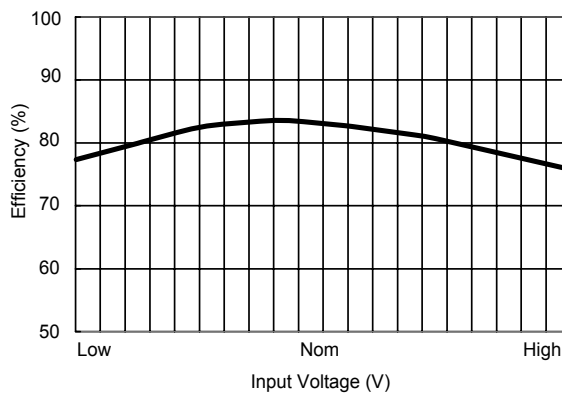

Efficiency vs Input Voltage (Dual Output)

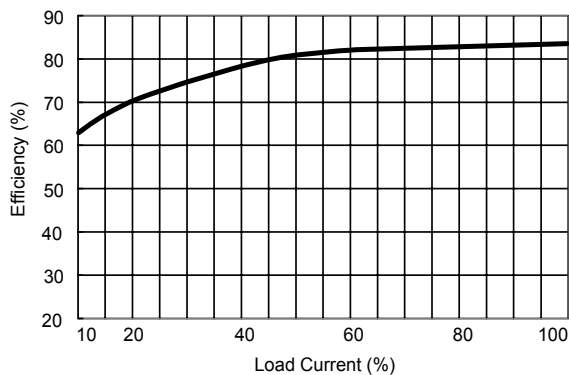

Efficiency vs Output Load (Single Output)

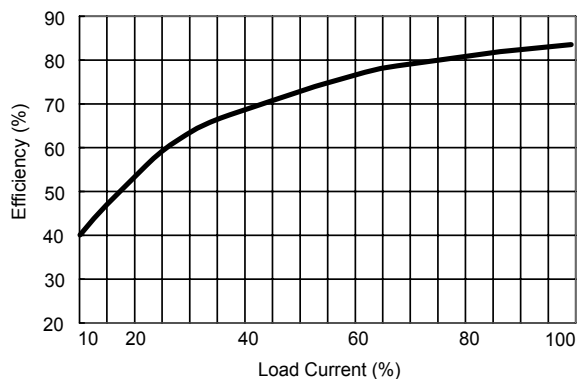

Efficiency vs Output Load (Dual Output)

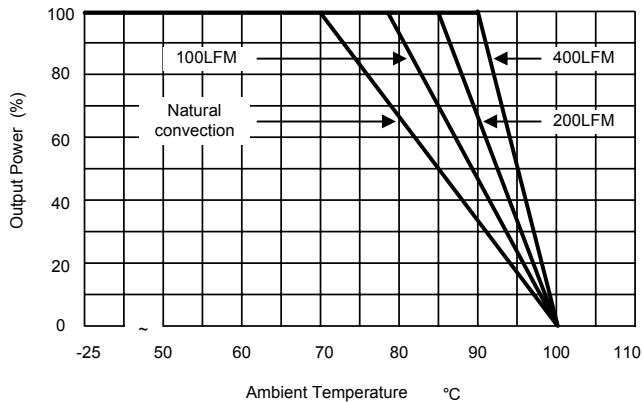

Derating Curve

Test Configurations

Input Reflected-Ripple Current Test Setup

Input reflected-ripple current is measured with an inductor L_{in} (4.7uH) and C_{in} (220uF, ESR < 1.0Ω at 100 KHz) to simulate source impedance.

Capacitor C_{in} , offsets possible battery impedance.

Current ripple is measured at the input terminals of the module, measurement bandwidth is 0–500 KHz.

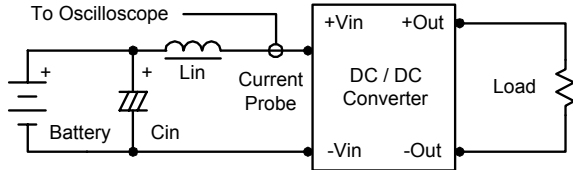

Peak-to-Peak Output Noise Measurement Test

Use a C_{out} 0.47uF ceramic capacitor.

Scope measurement should be made by using a BNC socket, measurement bandwidth is 0–20 MHz. Position the load between 50 mm and 75 mm from the DC/DC Converter.

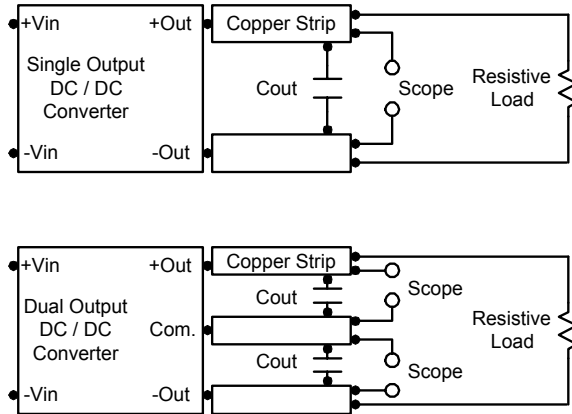

Design & Feature Considerations

Maximum Capacitive Load

The MIW1000 series has limitation of maximum connected capacitance at the output.

The power module may be operated in current limiting mode during start-up, affecting the ramp-up and the startup time.

For optimum performance we recommend 1000uF maximum capacitive load for dual outputs and 4000uF capacitive load for single outputs.

The maximum capacitance can be found in the data sheet.

To provide protection in a fault (output overload) condition, the unit is equipped with internal current limiting circuitry and can endure current limiting for an unlimited duration. At the point of current-limit inception, the unit shifts from voltage control to current control. The unit operates normally once the output current is brought back into its specified range.

Input Source Impedance

The power module should be connected to a low ac-impedance input source. Highly inductive source impedances can affect the stability of the power module.

In applications where power is supplied over long lines and output loading is high, it may be necessary to use a capacitor at the input to ensure startup.

Capacitor mounted close to the power module helps ensure stability of the unit, it is recommended to use a good quality low Equivalent Series Resistance (ESR < 1.0Ω at 100 KHz) capacitor of a 8.2uF for the 5V input devices, a 3.3uF for the 12V input devices and a 1.5uF for the 24V and 48V devices.

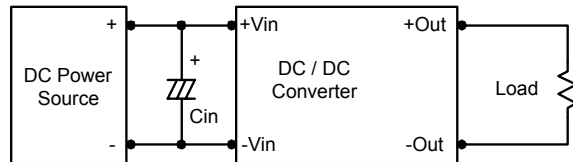

Output Ripple Reduction

A good quality low ESR capacitor placed as close as practicable across the load will give the best ripple and noise performance.

To reduce output ripple, it is recommended to use 3.3uF capacitors at the output.

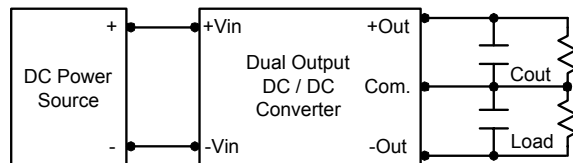
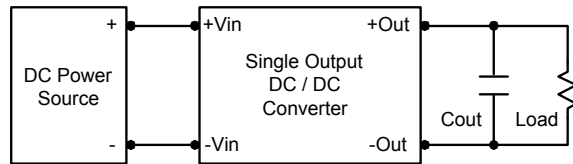

Overcurrent Protection

MIW1000 Series

Thermal Considerations

Many conditions affect the thermal performance of the power module, such as orientation, airflow over the module and board spacing. To avoid exceeding the maximum temperature rating of the components inside the power module, the case temperature must be kept below 90°C.

The derating curves are determined from measurements obtained in an experimental apparatus.

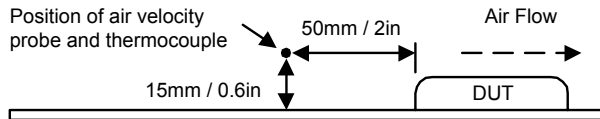

Mechanical Dimensions

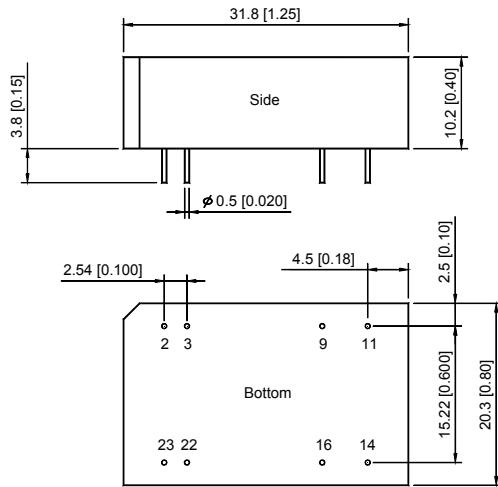

Physical Characteristics

Case Size	:	31.8×20.3×10.2 mm 1.25×0.80×0.40 inches
Case Material	:	Non-Conductive Black Plastic
Weight	:	12.4g
Flammability	:	UL94V-0

Tolerance	Millimeters	Inches
	X.X±0.25	X.XX±0.01
	X.XX±0.13	X.XXX±0.005
Pin	±0.05	±0.002

Pin Connections

Pin	Single Output	Dual Output
2	-Vin	-Vin
3	-Vin	-Vin
9	No Pin	Common
11	NC	-Vout
14	+Vout	+Vout
16	-Vout	Common
22	+Vin	+Vin
23	+Vin	+Vin

NC: No Connection