

# MA1010

## OUTLINE DIMENSIONS

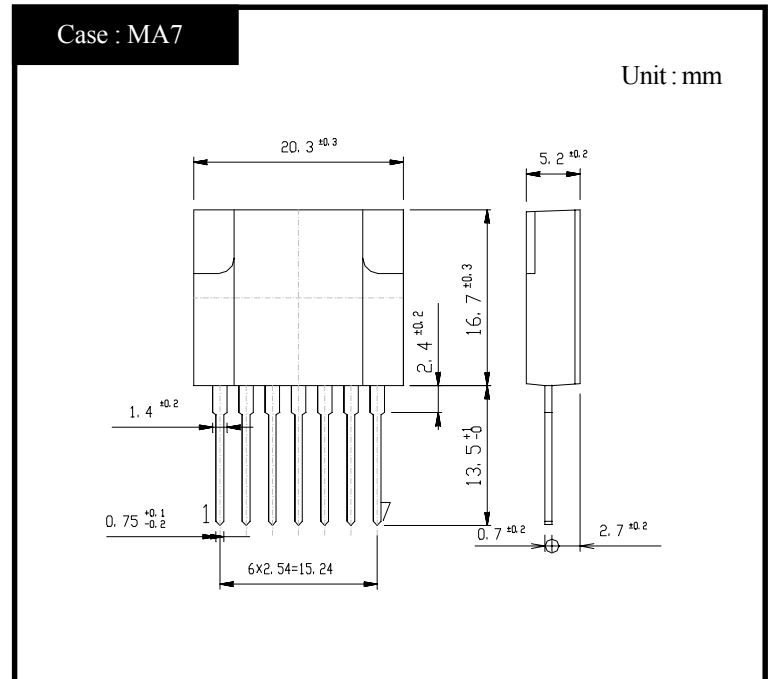

## RATINGS

### ● Absolute Maximum Ratings

Item	Symbol	Conditions	Ratings		Unit
			P Class	N Class	
Storage Temperature	Tstg		-30~125	-30~125	°C
Operating Temperature	Top	Case Temperature	-20~125	-20~125	°C
Junction Temperature	Tj		150	150	°C
Peak Input Voltage	Vin	②+,④-,Fig.1 is Measurement Circuit of Peak Input Voltage Vin and Collector Cutoff Current I <sub>CEX</sub> .	500	500	V
Input Current	Iin	Pulse Pulse Width 150 μs MAX, Duty 1/2, Sawtooth Wave, Peak Value, ②+,④-	6	6	A
Maximum Operating Frequency	f(max)		200	200	kHz
Maximum Power Dissipation	P <sub>D</sub>	Ta=25°C	3	3	W
		Heatsink Tc=100°C	12	12	W
Dielectric Strength	Vdis	Terminals To Case AC 1 min	2	2	kV
Insulation Resistance		Terminals To Case 500VDC	100	100	MΩ
Fold Back Control Voltage	V <sub>CONT(max)</sub>	Fold Control Resistance=0Ω Duty 1/2, ④,⑦	±8	±8	V
Fold Back Control Current	I <sub>CONT(max)</sub>	④-,⑥+	100	100	mA

### ● Electrical Characteristics (Tc=25°C)

Item	Symbol	Conditions	Ratings		Unit
			P Class	N Class	
Q1	Collector Cutoff Current	I <sub>CEX</sub>	V <sub>CE</sub> =500V, Fig.1 is Measurement Circuit of Peak Input Voltage Vin and Collector Cutoff Current I <sub>CEX</sub> , ②+,④-		mA
	DC Current Gain	h <sub>FE</sub>	15~30	10~20	
	Collector to Emitter Saturation Voltage	V <sub>CE(sat)</sub>	I <sub>C</sub> =1.5A, I <sub>B</sub> =0.3A, ②+,④-,⑤I <sub>B</sub>	MAX 1.0	MAX 1.0
	Thermal Resistance	θ <sub>jc</sub>	MAX 4.17	MAX 4.17	°C/W
D1	Reverse Current	I <sub>R</sub>	MAX 10	MAX 10	μA
	Forward Voltage	V <sub>F</sub>	MAX 1.7	MAX 1.7	V
Driving Saturation Voltage	V <sub>D(sat)</sub>	I <sub>C</sub> =1.5A, I <sub>B</sub> =0.3A, ⑤+,④-	MIN 1.7	MIN 1.7	V
			MAX 2.3	MAX 2.3	

●Standard Operating Condition•Design Standard For Application Circuit

Item	Conditions	Ratings		Unit
		P Class	N Class	
Input Rated Voltage		AC90~132	AC90~132	V
Output Nominal Wattage		12	12	W
Output Nominal Voltage		12	12	V
Output Nominal Current		1	1	A

●Standard Operating Condition•Standard Operating Characteristics (Ta=25°C)

Item	Conditions	Ratings		Unit		
		P Class	N Class			
Minimum Input Full Load Output Voltage	V <sub>in</sub> =90V, I <sub>O</sub> =1A	12.0±0.6	12.0±0.6	V	Fig 2, ① Refer	
Maximum Input Light Load Output Voltage	V <sub>in</sub> =132V, I <sub>O</sub> =0.1A	12.0±0.6	12.0±0.6	V	Fig 2, ② Refer	
AC Input Voltage	I <sub>O</sub> =1A	MAX 85	MAX 85	V		
Over Current Protection	Foldback Current	V <sub>in</sub> =132V, V <sub>O</sub> =10V	MAX 1.5	MAX 1.5	A	Fig 2, ③ Refer
	Short Circuit	V <sub>in</sub> =132V, R <sub>O</sub> =0.5Ω	Nodamage To Any Device, Automatic Recovery.		-	Fig 2, ④ Refer
Output Ripple Noise	V <sub>in</sub> =90~132V, I <sub>O</sub> =0.1~1A	MAX 150	MAX 150	mV P-P		

Figure in ○=Terminal Sign

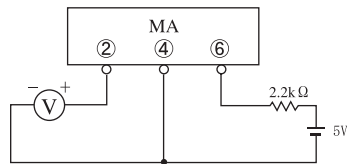

Fig1. Measurement Circuit

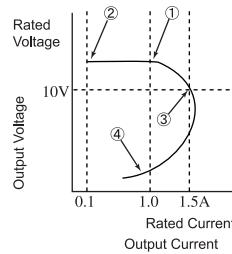
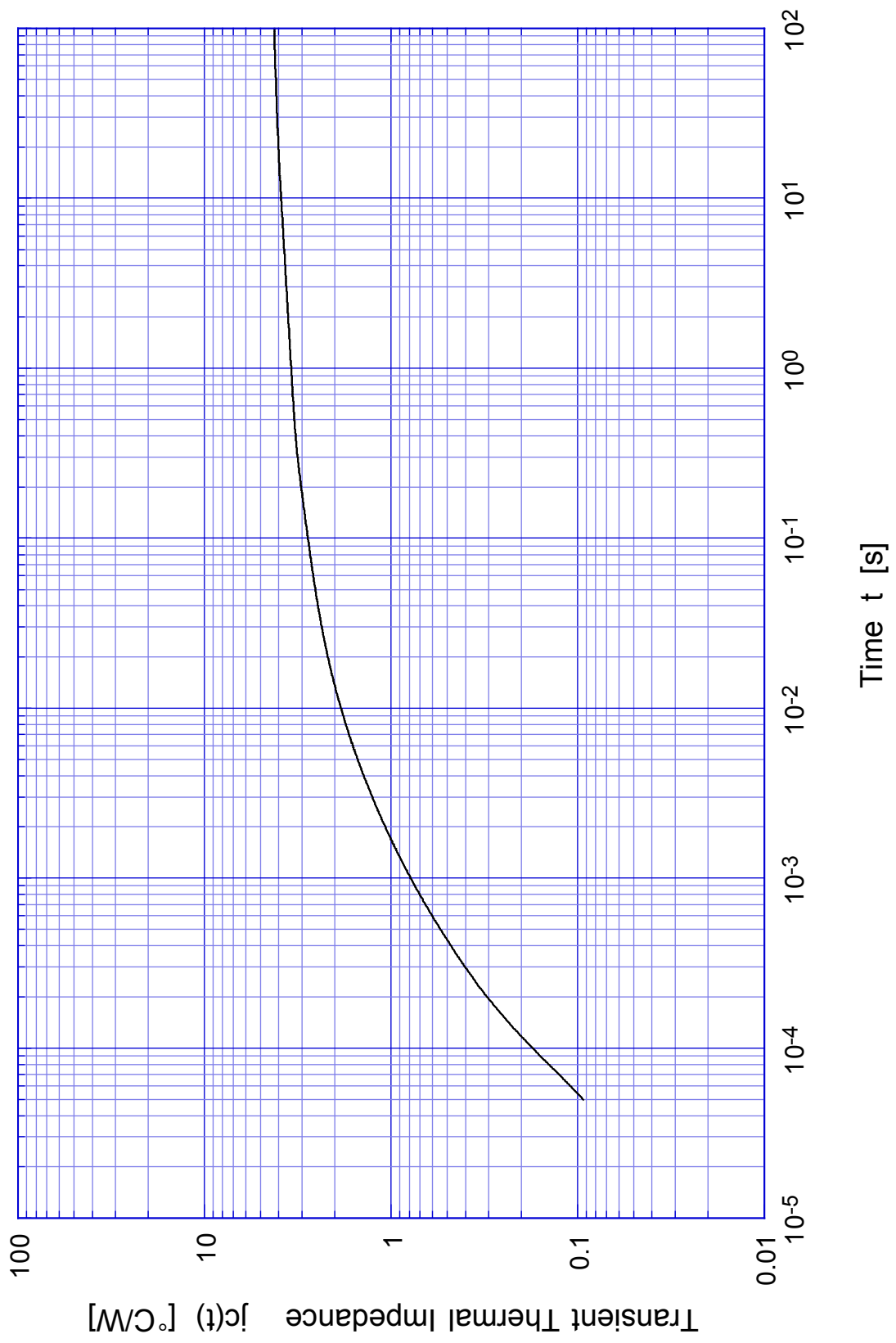

Fig2. Output Voltage/Current

# MA1010 Transient Thermal Impedance



# MA1010

# Forward Bias SOA

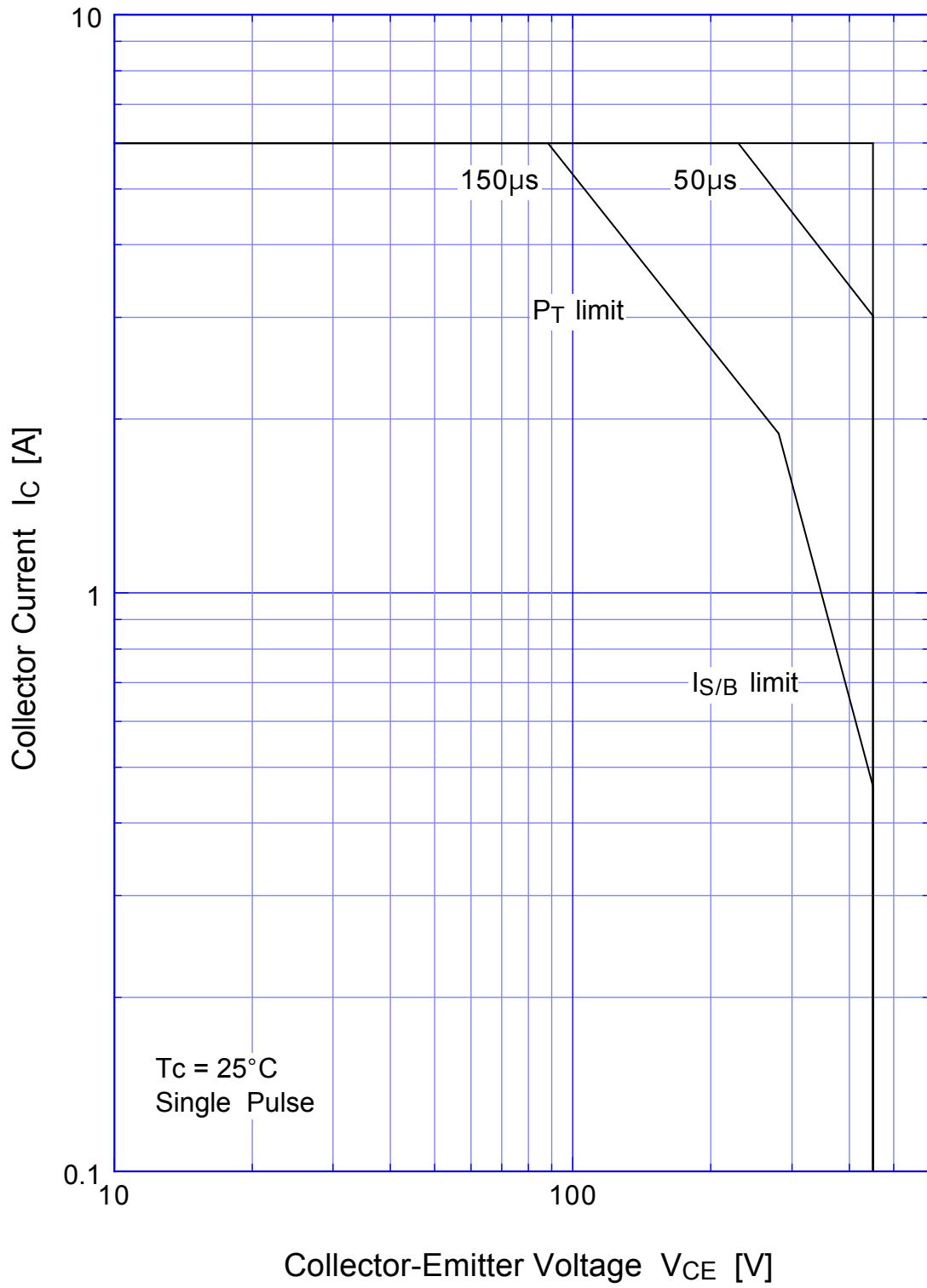

# MA1010

## Collector Current Derating

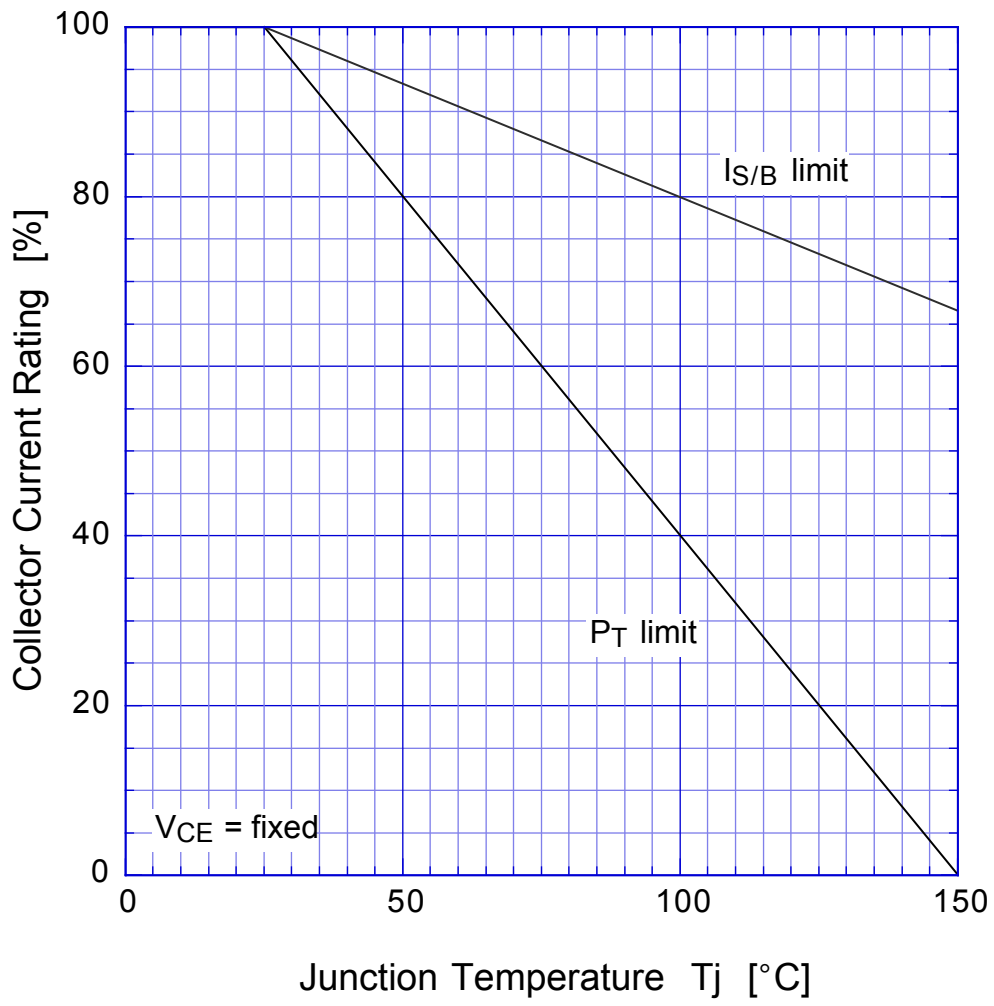

MA1010

Reverse Bias SOA

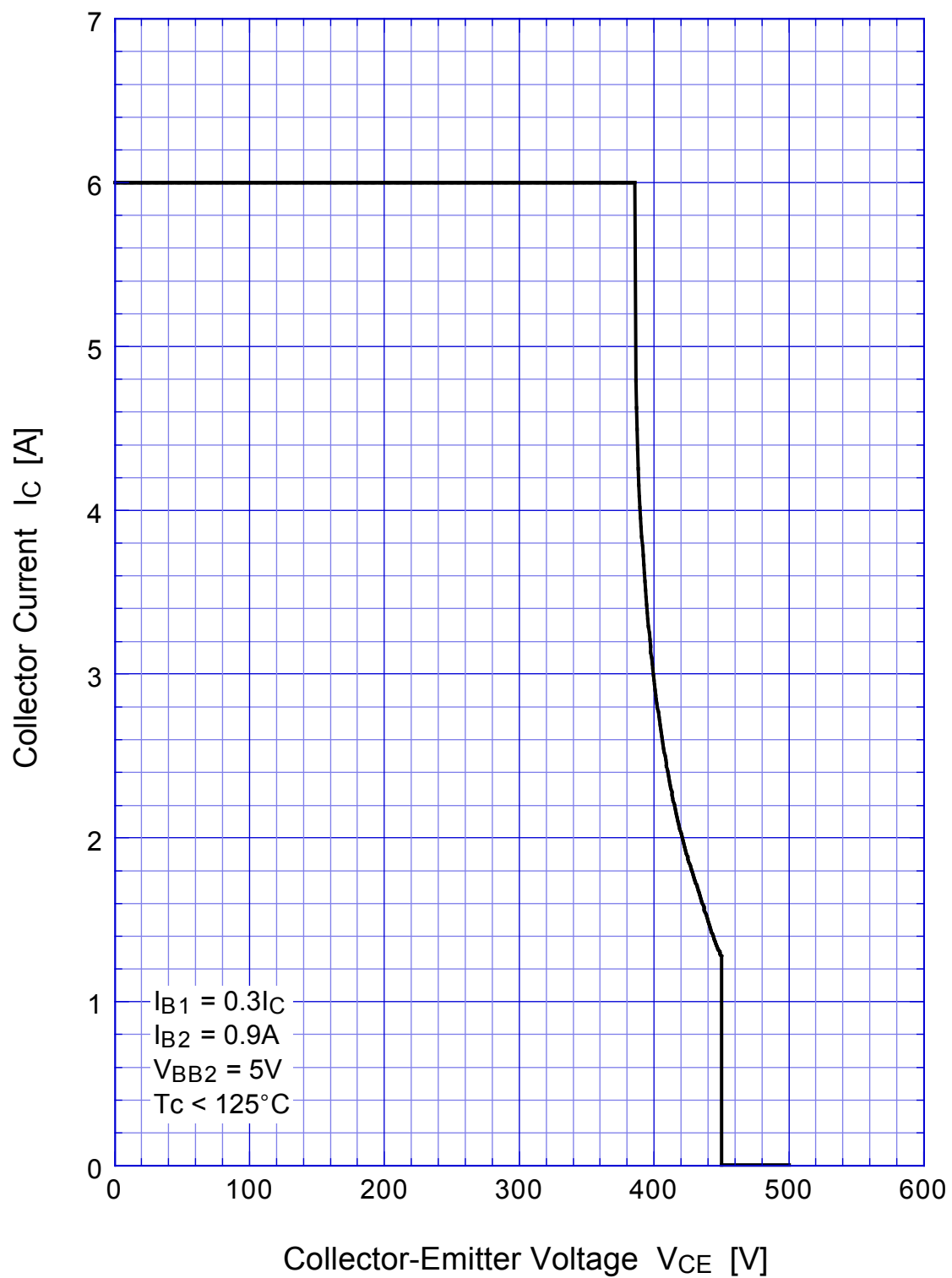

# MA1010

$h_{FE} - I_C$

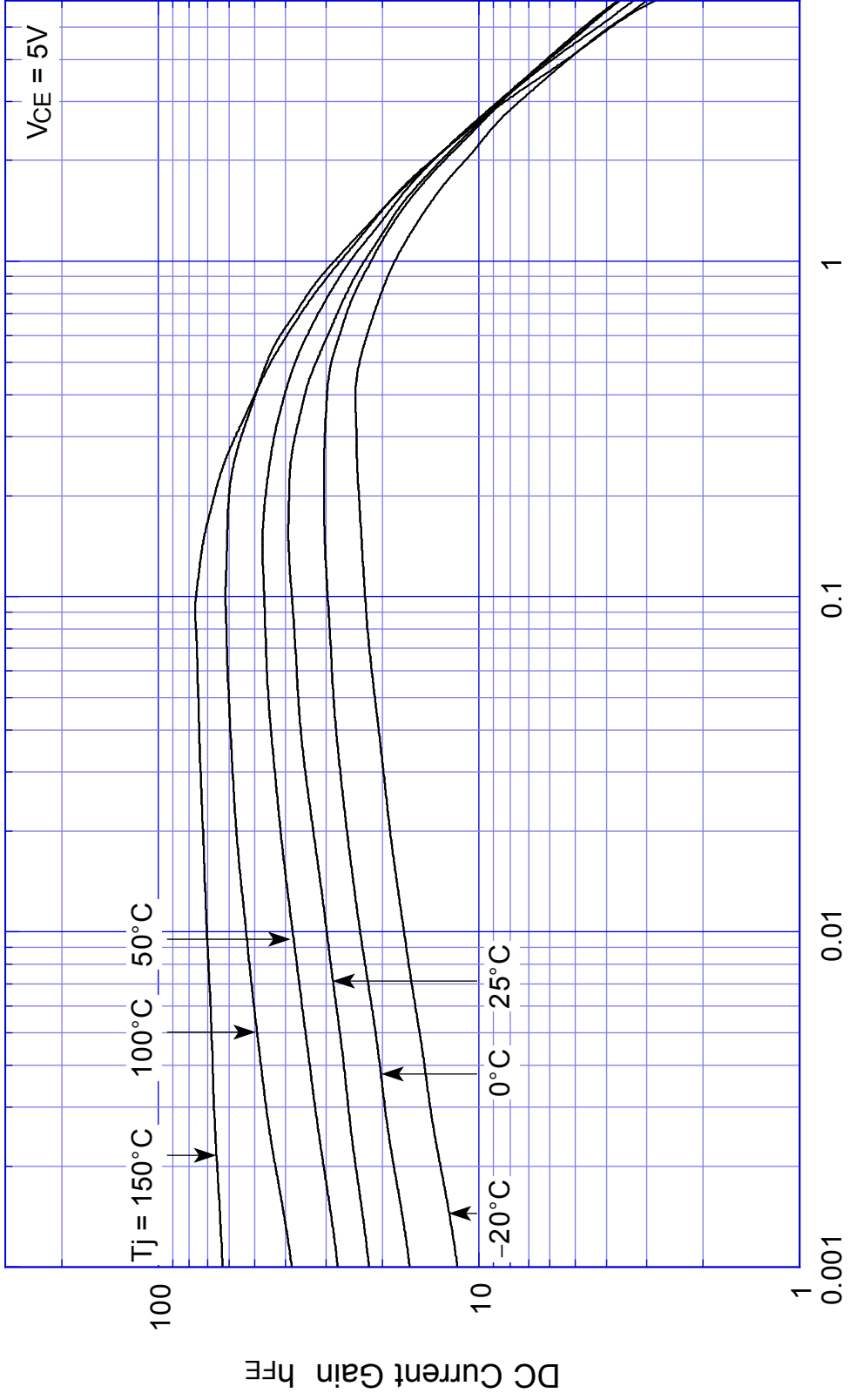

Collector Current  $I_C$  [A]

This datasheet has been download from:

[www.datasheetcatalog.com](http://www.datasheetcatalog.com)

Datasheets for electronics components.