

July 2005



# Single-channel: 6N135, 6N136, HCPL-2503, HCPL-4502 Dual-Channel: HCPL-2530, HCPL-2531 High Speed Transistor Optocouplers

## Features

- High speed-1 MBit/s
- Superior CMR-10 kV/μs
- Dual-Channel HCPL-2530/HCPL-2531
- Double working voltage-480V RMS
- CTR guaranteed 0-70°C
- U.L. recognized (File # E90700)

## Applications

- Line receivers
- Pulse transformer replacement
- Output interface to CMOS-LSTTL-TTL
- Wide bandwidth analog coupling

## Description

The HCPL-4502/HCPL-2503, 6N135/6 and HCPL-2530/HCPL-2531 optocouplers consist of an AlGaAs LED optically coupled to a high speed photodetector transistor.

A separate connection for the bias of the photodiode improves the speed by several orders of magnitude over conventional phototransistor optocouplers by reducing the base-collector capacitance of the input transistor.

An internal noise shield provides superior common mode rejection of 10kV/μs. An improved package allows superior insulation permitting a 480 V working voltage compared to industry standard of 220 V.

## Package

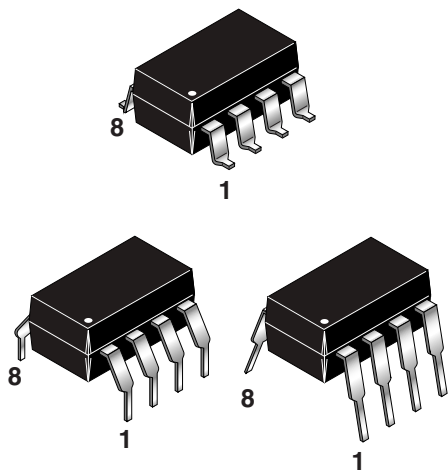

## Schematic

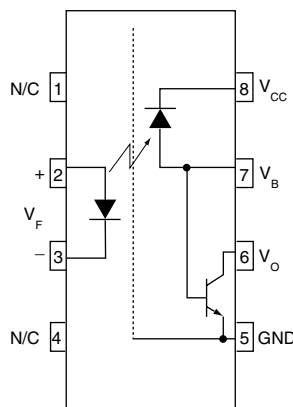

6N135, 6N136, HCPL-2503, HCPL-4502

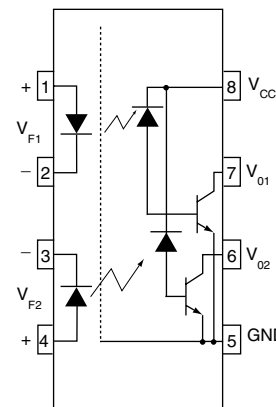

HCPL-2530/HCPL-2531

Pin 7 is not connected in Part Number HCPL-4502

Single-channel: 6N135, 6N136, HCPL-2503, HCPL-4502 Dual-Channel: HCPL-2530, HCPL-2531 High Speed Transistor Optocouplers

**Absolute Maximum Ratings** ( $T_A = 25^\circ\text{C}$  unless otherwise specified)

Parameter		Symbol	Value	Units
Storage Temperature		$T_{STG}$	-55 to +125	$^\circ\text{C}$
Operating Temperature		$T_{OPR}$	-55 to +100	$^\circ\text{C}$
Lead Solder Temperature		$T_{SOL}$	260 for 10 sec	$^\circ\text{C}$
<b>EMITTER</b>				
DC/Average Forward Input Current	Each Channel (Note 1)	$I_F$ (avg)	25	mA
Peak Forward Input Current (50% duty cycle, 1 ms P.W.)	Each Channel (Note 2)	$I_F$ (pk)	50	mA
Peak Transient Input Current - ( $\leq 1 \mu\text{s P.W.}$ , 300 pps)	Each Channel	$I_F$ (trans)	1.0	A
Reverse Input Voltage	Each Channel	$V_R$	5	V
Input Power Dissipation	(6N135/6N136 and HCPL-2503/4502) (HCPL-2530/2531) Each Channel (Note 3)	$P_D$	100 45	mW
<b>DETECTOR</b>				
Average Output Current	Each Channel	$I_O$ (avg)	8	mA
Peak Output Current	Each Channel	$I_O$ (pk)	16	mA
Emitter-Base Reverse Voltage	(6N135, 6N136 and HCPL-2503 only)	$V_{EBR}$	5	V
Supply Voltage		$V_{CC}$	-0.5 to 30	V
Output Voltage		$V_O$	-0.5 to 20	V
Base Current	(6N135, 6N136 and HCPL-2503 only)	$I_B$	5	mA
Output power dissipation	(6N135, 6N136, HCPL-2503, HCPL-4502) (Note 4)	PD	100	mW
	(HCPL-2530, HCPL-2531) Each Channel		35	mW

### Electrical Characteristics ( $T_A = 0$ to $70^\circ\text{C}$ Unless otherwise specified)

#### Individual Component Characteristics

Parameter	Test Conditions	Symbol	Device	Min	Typ**	Max	Unit
<b>EMITTER</b>							
Input Forward Voltage	( $I_F = 16\text{ mA}$ , $T_A = 25^\circ\text{C}$ )	$V_F$			1.45	1.7	V
	( $I_F = 16\text{ mA}$ )					1.8	
Input Reverse Breakdown Voltage	( $I_R = 10\ \mu\text{A}$ )	$B_{VR}$		5.0			V
Temperature coefficient of forward voltage	( $I_F = 16\text{ mA}$ )	( $\Delta V_F / \Delta T_A$ )			-1.6		mV/ $^\circ\text{C}$
<b>DETECTOR</b>							
Logic high output current	( $I_F = 0\text{ mA}$ , $V_O = V_{CC} = 5.5\text{ V}$ ) ( $T_A = 25^\circ\text{C}$ )	$I_{OH}$	All		0.001	0.5	$\mu\text{A}$
	( $I_F = 0\text{ mA}$ , $V_O = V_{CC} = 15\text{ V}$ ) ( $T_A = 25^\circ\text{C}$ )		6N135 6N136 HCPL-4502 HCPL-2503		0.005	1	
	( $I_F = 0\text{ mA}$ , $V_O = V_{CC} = 15\text{ V}$ )		All			50	
Logic low supply current	( $I_F = 16\text{ mA}$ , $V_O = \text{Open}$ ) ( $V_{CC} = 15\text{ V}$ )	$I_{CCL}$	6N135 6N136 HCPL-4502 HCPL-2503		120	200	$\mu\text{A}$
	( $I_{F1} = I_{F2} = 16\text{ mA}$ , $V_O = \text{Open}$ ) ( $V_{CC} = 15\text{ V}$ )		HCPL-2530 HCPL-2531		200	400	
Logic high supply current	( $I_F = 0\text{ mA}$ , $V_O = \text{Open}$ , $V_{CC} = 15\text{ V}$ ) ( $T_A = 25^\circ\text{C}$ )	$I_{CCH}$	6N135 6N136 HCPL-4502 HCPL-2503			1	$\mu\text{A}$
	( $I_F = 0\text{ mA}$ , $V_O = \text{Open}$ ) ( $V_{CC} = 15\text{ V}$ )		6N135 6N136 HCPL-4502 HCPL-2503			2	
	( $I_F = 0\text{ mA}$ , $V_O = \text{Open}$ ) ( $V_{CC} = 15\text{ V}$ )		HCPL-2530 HCPL-2531		0.02	4	

\*\* All Typicals at  $T_A = 25^\circ\text{C}$

**Transfer Characteristics** ( $T_A = 0$  to  $70^\circ\text{C}$  Unless otherwise specified)

Parameter	Test Conditions	Symbol	Device	Min	Typ**	Max	Unit	
<b>COUPLED</b>  Current transfer ratio (Note 5)	$(I_F = 16 \text{ mA}, V_O = 0.4 \text{ V})$ $(V_{CC} = 4.5 \text{ V}, T_A = 25^\circ\text{C})$	CTR	6N135 HCPL-2530	7	18	50	%	
			6N136 HCPL-4502 HCPL-2531	19	27	50	%	
			HCPL-2503	12	27		%	
	$(I_F = 16 \text{ mA}, V_{CC} = 4.5 \text{ V})$			$V_{OL}=0.4\text{V}$	5	21		%
				$V_{OL}=0.5\text{V}$				
				$V_{OL}=0.4\text{V}$	15	30		%
				$V_{OL}=0.5\text{V}$				
	$V_{OL}=0.4\text{V}$	9	30		%			
Logic low output voltage output voltage	$(I_F = 16 \text{ mA}, I_O = 1.1 \text{ mA})$ $(V_{CC} = 4.5 \text{ V}, T_A = 25^\circ\text{C})$	V <sub>OL</sub>	6N135		0.18	0.4	V	
			HCPL-2530		0.18	0.5		
	$(I_F = 16 \text{ mA}, I_O = 3 \text{ mA})$ $(V_{CC} = 4.5 \text{ V}, T_A = 25^\circ\text{C})$			6N136 HCPL-2503		0.25	0.4	
				HCPL-2531		0.25	0.5	
	$(I_F = 16 \text{ mA}, I_O = 0.8 \text{ mA})$ $(V_{CC} = 4.5 \text{ V})$			6N135 HCPL-2530			0.5	
				HCPL-4502 HCPL-2531			0.5	

\*\* All Typicals at  $T_A = 25^\circ\text{C}$

**Switching Characteristics** ( $T_A = 0$  to  $70^\circ\text{C}$  unless otherwise specified.,  $V_{CC} = 5\text{ V}$ )

Parameter	Test Conditions	Symbol	Device	Min	Typ**	Max	Unit
Propagation delay time to logic low	$T_A = 25^\circ\text{C}$ , ( $R_L = 4.1\text{ k}\Omega$ , $I_F = 16\text{ mA}$ ) (Note 6) (Fig. 7)	$T_{PHL}$	6N135 HCPL-2530		0.45	1.5	$\mu\text{s}$
	$(R_L = 1.9\text{ k}\Omega$ , $I_F = 16\text{ mA}$ ) (Note 7) (Fig. 7) $T_A = 25^\circ\text{C}$		6N136 HCPL-4502 HCPL-2503 HCPL-2531		0.45	0.8	$\mu\text{s}$
	$(R_L = 4.1\text{ k}\Omega$ , $I_F = 16\text{ mA}$ ) (Note 6) (Fig. 7)		6N135 HCPL-2530			2.0	$\mu\text{s}$
	$(R_L = 1.9\text{ k}\Omega$ , $I_F = 16\text{ mA}$ ) (Note 7) (Fig. 7)		6N136 HCPL-4502 HCPL-2503 HCPL-2531			1.0	$\mu\text{s}$
Propagation delay time to logic high	$T_A = 25^\circ\text{C}$ , ( $R_L = 4.1\text{ k}\Omega$ , $I_F = 16\text{ mA}$ ) (Note 6) (Fig. 7)	$T_{PLH}$	6N135 HCPL-2530		0.5	1.5	$\mu\text{s}$
	$(R_L = 1.9\text{ k}\Omega$ , $I_F = 16\text{ mA}$ ) (Note 7) (Fig. 7) $T_A = 25^\circ\text{C}$		6N136 HCPL-4502 HCPL-2503 HCPL-2531		0.3	0.8	$\mu\text{s}$
	$(R_L = 4.1\text{ k}\Omega$ , $I_F = 16\text{ mA}$ ) (Note 6) (Fig. 7)		6N135 HCPL-2530			2.0	$\mu\text{s}$
	$(R_L = 1.9\text{ k}\Omega$ , $I_F = 16\text{ mA}$ ) (Note 7) (Fig. 7)		6N136 HCPL-4502 HCPL-2503 HCPL-2531			1.0	$\mu\text{s}$
Common mode transient immunity at logic high	$(I_F = 0\text{ mA}$ , $V_{CM} = 10\text{ V}_{P-P}$ , $R_L = 4.1\text{ k}\Omega$ ) (Note 8) (Fig. 8) $T_A = 25^\circ\text{C}$	$ICM_H$	6N135 HCPL-2530		10,000		$\text{V}/\mu\text{s}$
	$(I_F = 0\text{ mA}$ , $V_{CM} = 10\text{ V}_{P-P}$ ) $T_A = 25^\circ\text{C}$ , ( $R_L = 1.9\text{ k}\Omega$ ) (Note 8) (Fig. 8)		6N136 HCPL-4502 HCPL-2503 HCPL-2531		10,000		$\text{V}/\mu\text{s}$
Common mode transient immunity at logic low	$(I_F = 16\text{ mA}$ , $V_{CM} = 10\text{ V}_{P-P}$ , $R_L = 4.1\text{ k}\Omega$ ) (Note 8) (Fig. 8) $T_A = 25^\circ\text{C}$	$ICM_L$	6N135 HCPL-2530		10,000		$\text{V}/\mu\text{s}$
	$(I_F = 16\text{ mA}$ , $V_{CM} = 10\text{ V}_{P-P}$ ) ( $R_L = 1.9\text{ k}\Omega$ ) (Note 8) (Fig. 8)		6N136 HCPL-4502 HCPL-2503 HCPL-2531		10,000		$\text{V}/\mu\text{s}$

 \*\* All Typicals at  $T_A = 25^\circ\text{C}$

**Isolation Characteristics** ( $T_A = 0$  to  $70^\circ\text{C}$  Unless otherwise specified)

Characteristics	Test Conditions	Symbol	Min	Typ**	Max	Unit
Input-output insulation leakage current	(Relative humidity = 45%) ( $T_A = 25^\circ\text{C}$ , $t = 5$ s) ( $V_{I-O} = 3000$ VDC) (Note 9)	$I_{I-O}$			1.0	$\mu\text{A}$
Withstand insulation test voltage	(RH $\leq$ 50%, $T_A = 25^\circ\text{C}$ ) (Note 9) ( $t = 1$ min.)	$V_{ISO}$	2500			$V_{RMS}$
Resistance (input to output)	(Note 9) ( $V_{I-O} = 500$ VDC)	$R_{I-O}$		$10^{12}$		$\Omega$
Capacitance (input to output)	(Note 9) ( $f = 1$ MHz)	$C_{I-O}$		0.6		pF
DC Current gain	( $I_O = 3$ mA, $V_O = 5$ V)	HFE		150		
Input-Input Insulation leakage current	(RH $\leq$ 45%, $V_{I-I} = 500$ VDC) (Note 10) $t = 5$ s, (HCPL-2530/2531 only)	$I_{I-I}$		0.005		$\mu\text{A}$
Input-Input Resistance	( $V_{I-I} = 500$ VDC) (Note 10) (HCPL-2530/2531 only)	$R_{I-I}$		$10^{11}$		$\Omega$
Input-Input Capacitance	( $f = 1$ MHz) (Note 10) (HCPL-2530/2531 only)	$C_{I-I}$		0.03		pF

**Notes**

- Derate linearly above  $70^\circ\text{C}$  free-air temperature at a rate of  $0.8$  mA/ $^\circ\text{C}$ .
- Derate linearly above  $70^\circ\text{C}$  free-air temperature at a rate of  $1.6$  mA/ $^\circ\text{C}$ .
- Derate linearly above  $70^\circ\text{C}$  free-air temperature at a rate of  $0.9$  mW/ $^\circ\text{C}$ .
- Derate linearly above  $70^\circ\text{C}$  free-air temperature at a rate of  $2.0$  mW/ $^\circ\text{C}$ .
- Current Transfer Ratio is defined as a ratio of output collector current,  $I_O$ , to the forward LED input current,  $I_F$ , times 100%.
- The  $4.1$  k $\Omega$  load represents 1 LSTTL unit load of  $0.36$  mA and  $6.1$  k $\Omega$  pull-up resistor.
- The  $1.9$  k $\Omega$  load represents 1 TTL unit load of  $1.6$  mA and  $5.6$  k $\Omega$  pull-up resistor.
- Common mode transient immunity in logic high level is the maximum tolerable (positive)  $dV_{cm}/dt$  on the leading edge of the common mode pulse signal  $V_{CM}$ , to assure that the output will remain in a logic high state (i.e.,  $V_O > 2.0$  V). Common mode transient immunity in logic low level is the maximum tolerable (negative)  $dV_{cm}/dt$  on the trailing edge of the common mode pulse signal,  $V_{CM}$ , to assure that the output will remain in a logic low state (i.e.,  $V_O < 0.8$  V).
- Device is considered a two terminal device: Pins 1, 2, 3 and 4 are shorted together and Pins 5, 6, 7 and 8 are shorted together.
- Measured between pins 1 and 2 shorted together, and pins 3 and 4 shorted together.

Fig. 1 Normalized CTR vs. Forward Current

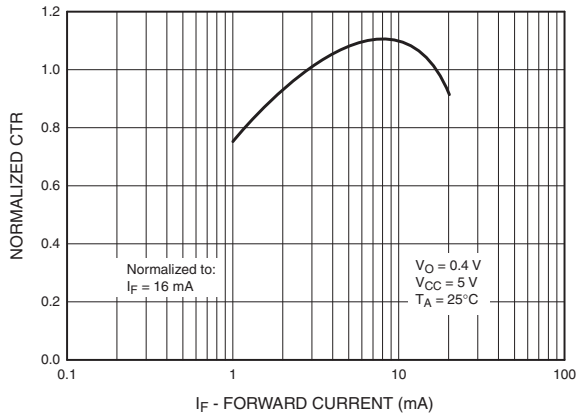

Fig. 2 Normalized CTR vs. Temperature

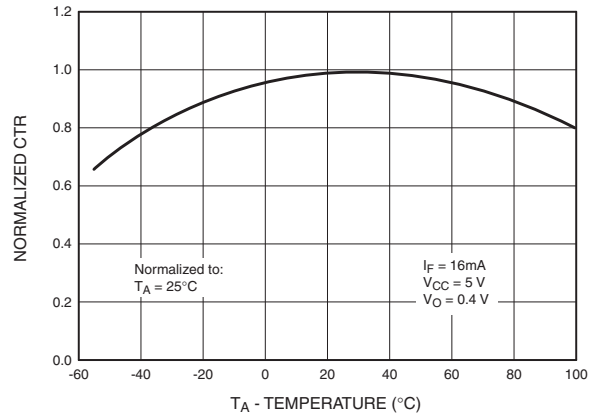

Fig. 3 Output Current vs. Output Voltage

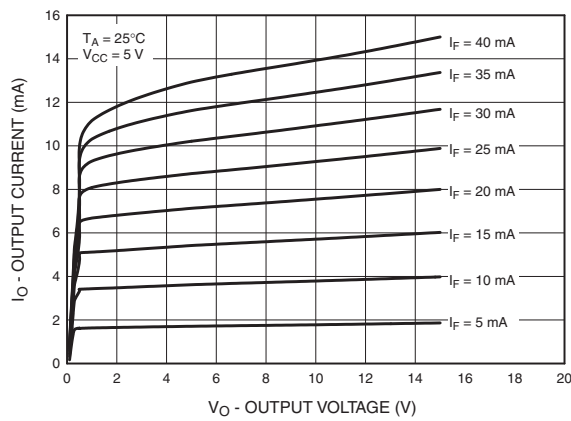

Fig. 4 Logic High Output Current vs. Temperature

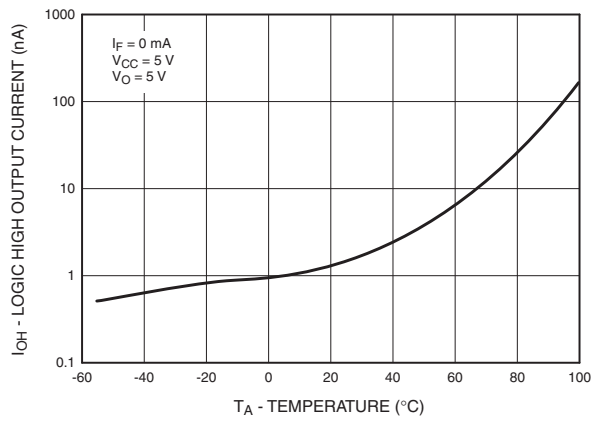

Fig. 5 Propagation Delay vs. Temperature

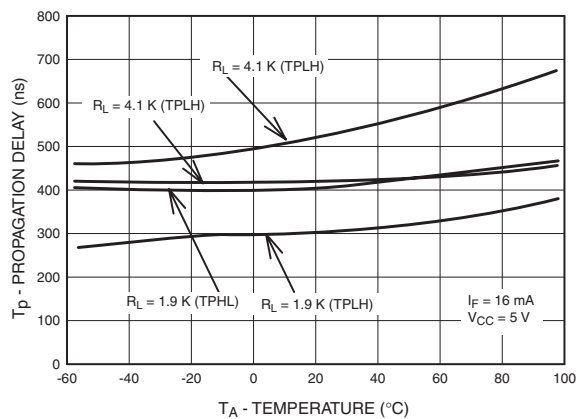
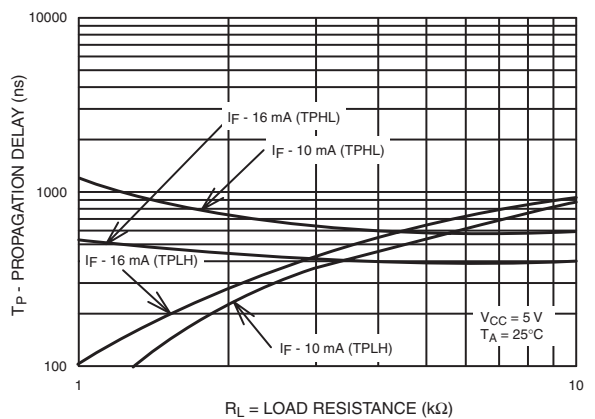
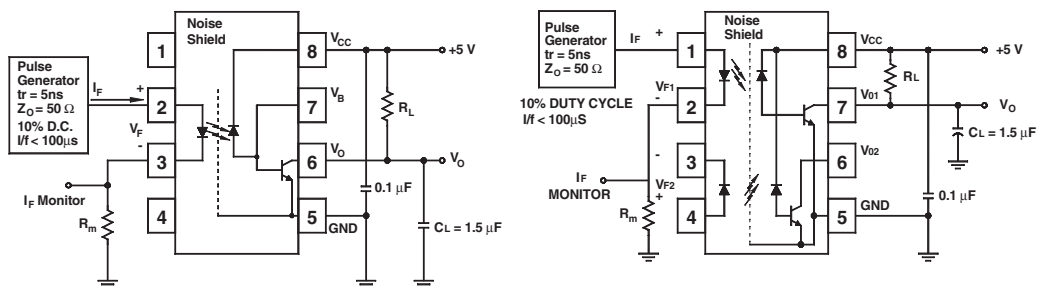

Fig. 6 Propagation Delay vs. Load Resistance





Test Circuit for 6N135, 6N136, HCPL-2503 and HCPL-4502

Test Circuit for HCPL-2530 and HCPL-2531

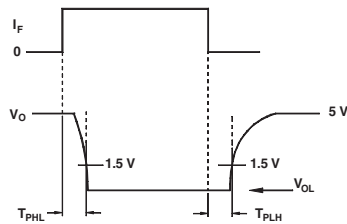
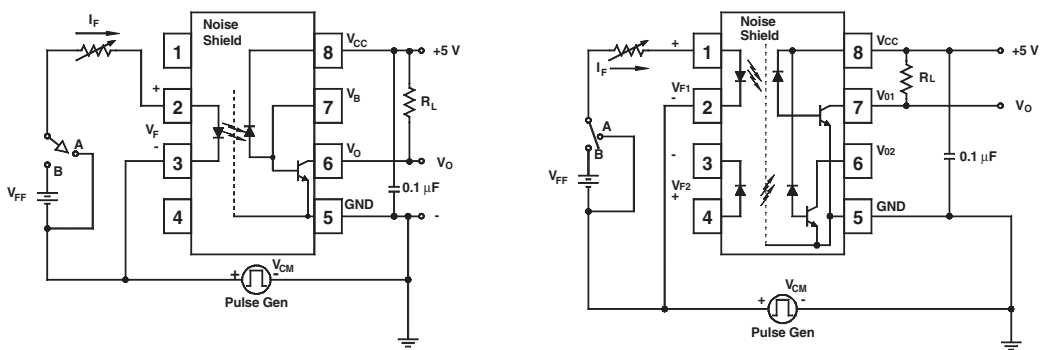

Fig. 7 Switching Time Test Circuit



Test Circuit for 6N135, 6N136, HCPL-2503 and HCPL-4502

Test Circuit for HCPL-2530 and HCPL-2531

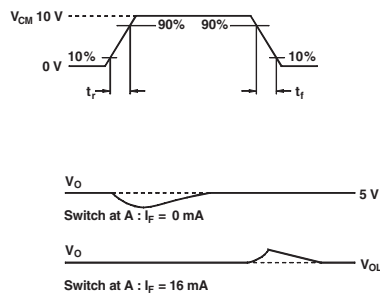

Fig. 8 Common Mode Immunity Test Circuit





### Ordering Information

Option	Example Part Number	Description
S	6N135S	Surface Mount Lead Bend
SD	6N135SD	Surface Mount; Tape and reel
W	6N135W	0.4" Lead Spacing
V	6N135V	VDE0884
TV	6N135TV	VDE0884; 0.4" lead spacing
SV	6N135SV	VDE0884; surface mount
SDV	6N135SDV	VDE0884; surface mount; tape and reel

### Marking Information

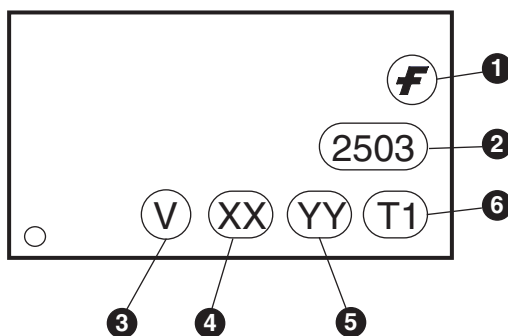

Definitions	
1	Fairchild logo
2	Device number
3	VDE mark (Note: Only appears on parts ordered with VDE option – See order entry table)
4	Two digit year code, e.g., '03'
5	Two digit work week ranging from '01' to '53'
6	Assembly package code

### Carrier Tape Specifications

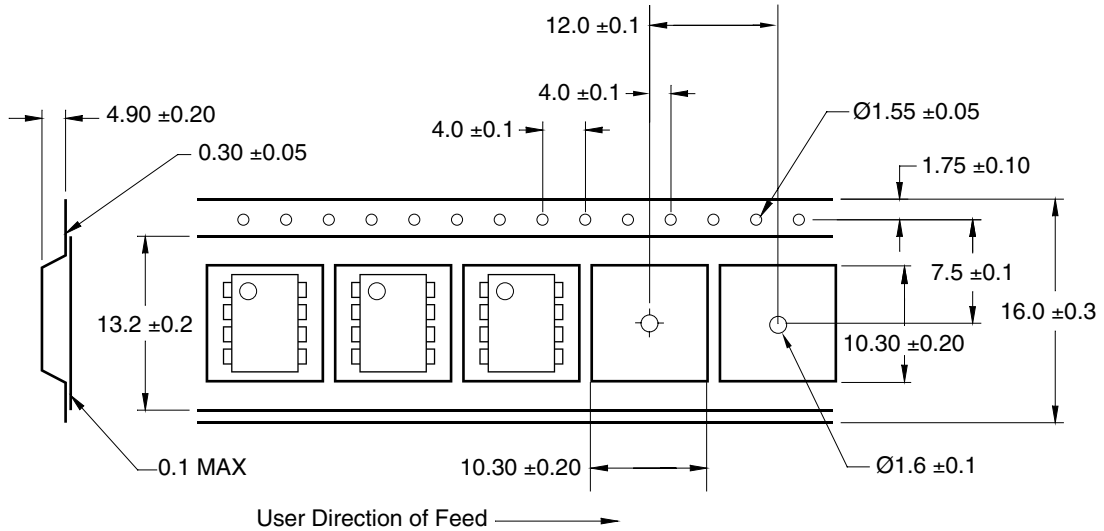

### Reflow Profile

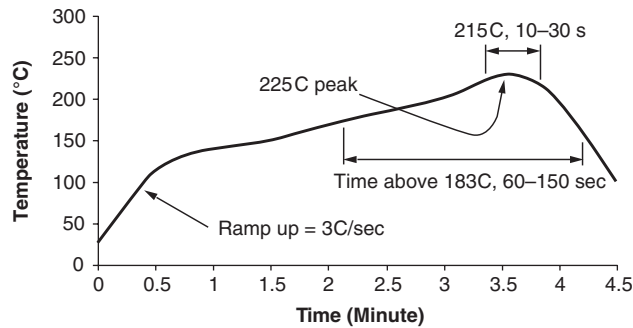

- Peak reflow temperature: 225C (package surface temperature)
- Time of temperature higher than 183C for 60-150 seconds
- One time soldering reflow is recommended

## TRADEMARKS

The following are registered and unregistered trademarks Fairchild Semiconductor owns or is authorized to use and is not intended to be an exhaustive list of all such trademarks.

ACEx™	FAST®	ISOPLANAR™	PowerSaver™	SuperSOT™-8
ActiveArray™	FASTr™	LittleFET™	PowerTrench®	SyncFET™
Bottomless™	FPST™	MICROCOUPLER™	QFET®	TinyLogic®
Build it Now™	FRFET™	MicroFET™	QS™	TINYOPTO™
CoolFET™	GlobalOptoisolator™	MicroPak™	QT Optoelectronics™	TruTranslation™
CROSSVOLT™	GTO™	MICROWIRE™	Quiet Series™	UHC™
DOMET™	HiSeC™	MSX™	RapidConfigure™	UltraFET®
EcoSPARK™	I <sup>2</sup> C™	MSXPro™	RapidConnect™	UniFET™
E <sup>2</sup> CMOSTM	i-Lo™	OCXTM	µSerDes™	VCX™
EnSigna™	ImpliedDisconnect™	OCXPro™	SILENT SWITCHER®	Wire™
FACT™	IntelliMAX™	OPTOLOGIC®	SMART START™	
FACT Quiet Series™		OPTOPLANAR™	SPM™	
Across the board. Around the world.™		PACMAN™	Stealth™	
The Power Franchise®		POPTM	SuperFET™	
Programmable Active Droop™		Power247™	SuperSOT™-3	
		PowerEdge™	SuperSOT™-6	

## DISCLAIMER

FAIRCHILD SEMICONDUCTOR RESERVES THE RIGHT TO MAKE CHANGES WITHOUT FURTHER NOTICE TO ANY PRODUCTS HEREIN TO IMPROVE RELIABILITY, FUNCTION OR DESIGN. FAIRCHILD DOES NOT ASSUME ANY LIABILITY ARISING OUT OF THE APPLICATION OR USE OF ANY PRODUCT OR CIRCUIT DESCRIBED HEREIN; NEITHER DOES IT CONVEY ANY LICENSE UNDER ITS PATENT RIGHTS, NOR THE RIGHTS OF OTHERS.

## LIFE SUPPORT POLICY

FAIRCHILD'S PRODUCTS ARE NOT AUTHORIZED FOR USE AS CRITICAL COMPONENTS IN LIFE SUPPORT DEVICES OR SYSTEMS WITHOUT THE EXPRESS WRITTEN APPROVAL OF FAIRCHILD SEMICONDUCTOR CORPORATION. As used herein:

1. Life support devices or systems are devices or systems which, (a) are intended for surgical implant into the body, or (b) support or sustain life, or (c) whose failure to perform when properly used in accordance with instructions for use provided in the labeling, can be reasonably expected to result in significant injury to the user.
2. A critical component is any component of a life support device or system whose failure to perform can be reasonably expected to cause the failure of the life support device or system, or to affect its safety or effectiveness.

## PRODUCT STATUS DEFINITIONS

### Definition of Terms

Datasheet Identification	Product Status	Definition
Advance Information	Formative or In Design	This datasheet contains the design specifications for product development. Specifications may change in any manner without notice.
Preliminary	First Production	This datasheet contains preliminary data, and supplementary data will be published at a later date. Fairchild Semiconductor reserves the right to make changes at any time without notice in order to improve design.
No Identification Needed	Full Production	This datasheet contains final specifications. Fairchild Semiconductor reserves the right to make changes at any time without notice in order to improve design.
Obsolete	Not In Production	This datasheet contains specifications on a product that has been discontinued by Fairchild semiconductor. The datasheet is printed for reference information only.

Rev. 116



**Datasheet5**  
—集成电路查询网

超过3,000,000种电子元器件资料免费查询

[www.datasheet5.com](http://www.datasheet5.com)