

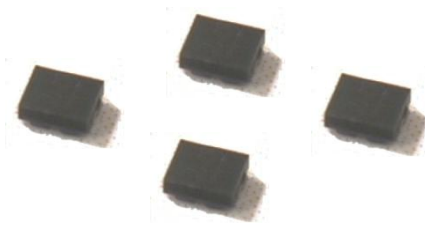

Data Sheet of SAW Components



Note : Murata SAW Component is applicable for Cellular /Cordless phone (Terminal) relevant market only.

Please also read caution at the end of this document.

SAW FILTER FOR GSM900/Band8 Rx

Murata part number: SAFEA942MFL0F00

Package Dimensions

Specification

Top View

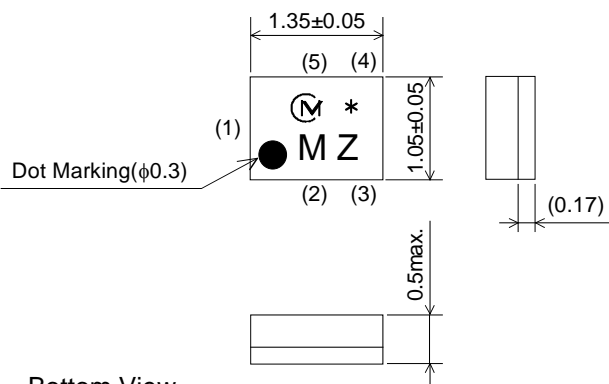

Bottom View

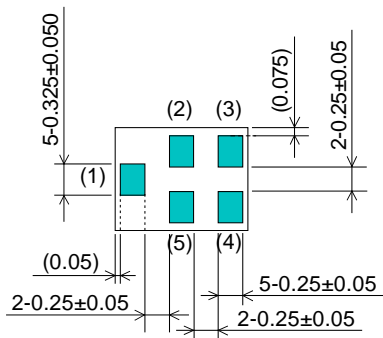

Marking
: Laser Printing

(1) : Unbalance Port
(3)(4) : Balance Port
Others : Ground

Unit : mm

| Item | Specification | | |
|--|-----------------------------|-------------------|-----------|
| | -30 to 85°C | 25±2°C | typ. |
| Nominal Center Frequency (fc) | 942.5MHz | | |
| Insertion Loss (925 to 960 MHz) | 2.3 dB max. | 1.9 dB max. | 1.6 dB |
| Absolute Attenuation | | | |
| 1) 0.1 to 860 MHz | 50 dB min. | 50 dB min. | 58 dB |
| 2) 860 to 880 MHz | 50 dB min. | 50 dB min. | 58 dB |
| 3) 880 to 905 MHz | 30 dB min. | 30 dB min. | 49 dB |
| 4) 905 to 915 MHz | 25 dB min. | 25 dB min. | 29 dB |
| 5) 980 to 1030 MHz | 25 dB min. | 25 dB min. | 29 dB |
| 6) 1030 to 1040 MHz | 45 dB min. | 45 dB min. | 50 dB |
| 7) 1040 to 2500 MHz | 45 dB min. | 45 dB min. | 55 dB |
| 8) 2500 to 6000 MHz | 35 dB min. | 35 dB min. | 49 dB |
| Ripple Deviation (925 to 960 MHz) | 1.4dB max. | 0.9dB max. | 0.4 dB |
| VSWR (925 to 960 MHz) | 2.0 max. | 1.9 max. | 1.7 |
| Amplitude Balance (925 to 960 MHz) | ±0.5dB max. | ±0.5dB max. | ±0.2 dB |
| Phase Balance (925 to 960 MHz) | 180±5deg. max. | 180±5deg. max. | ±1.5 deg. |
| Balance Port Matching Impedance (nominal) | 150Ω//82nH | | |
| Unbalance Port Matching Impedance (nominal) | 50Ω | | |
| Input Signal Level | 31.6mW (+15dBm), 2000 hours | | |

SAW FILTER FOR GSM900/Band8 Rx

Murata part number: SAFEA942MFL0F00

Frequency Performance

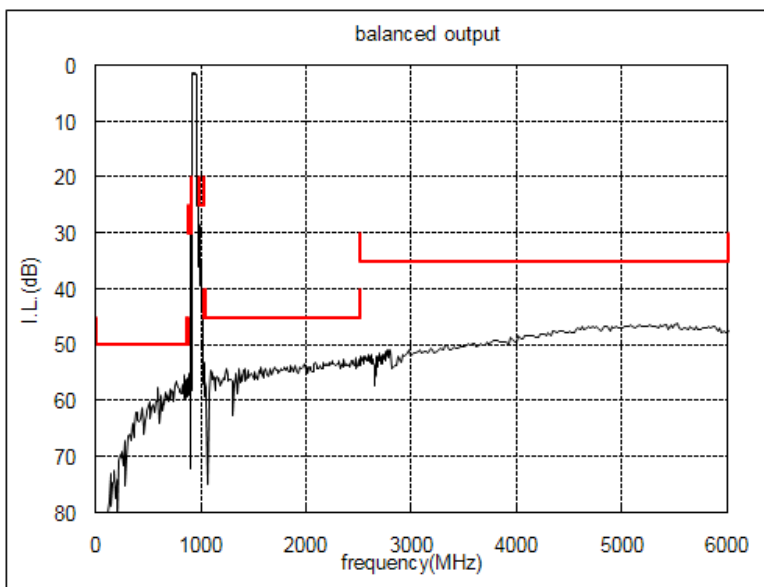
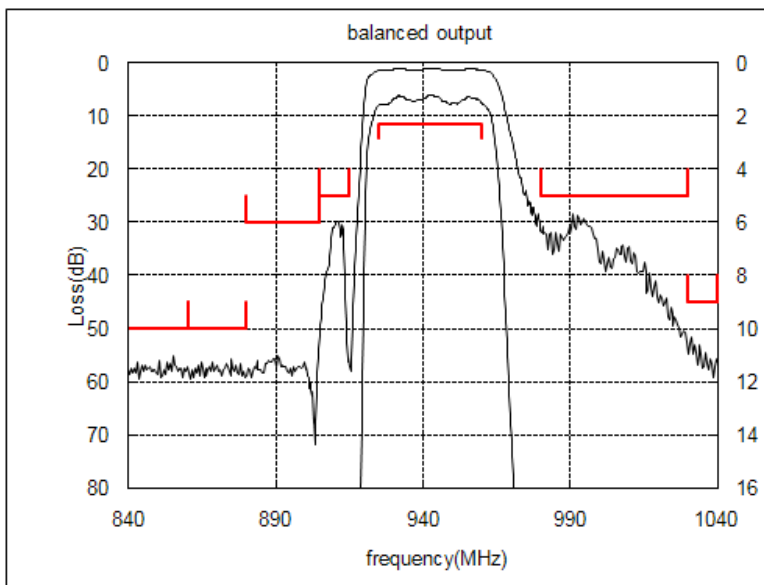

Amplitude balance

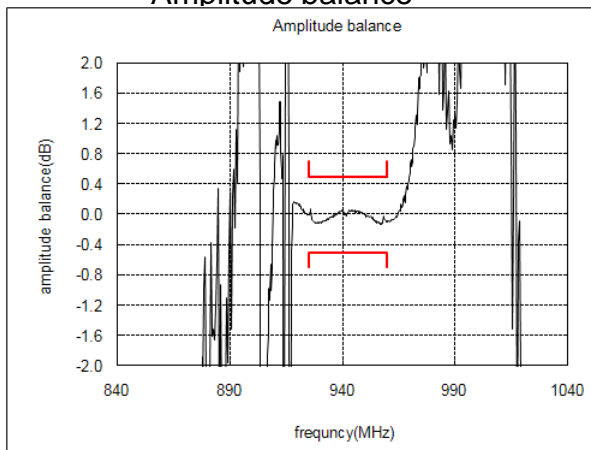

Phase balance

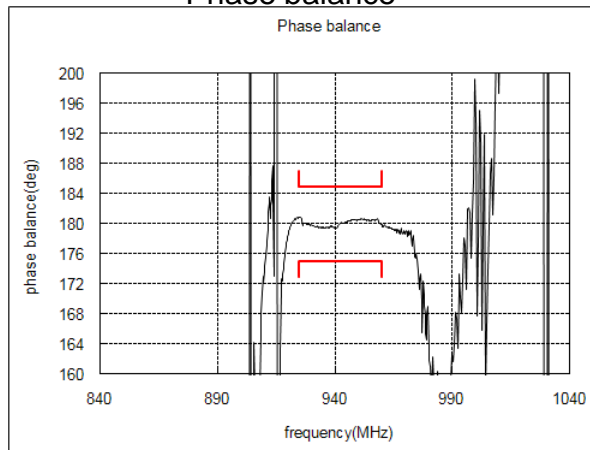

SAW FILTER FOR GSM900/Band8 Rx

Murata part number: SAFEA942MFL0F00

Dimensions of Carrier Tape

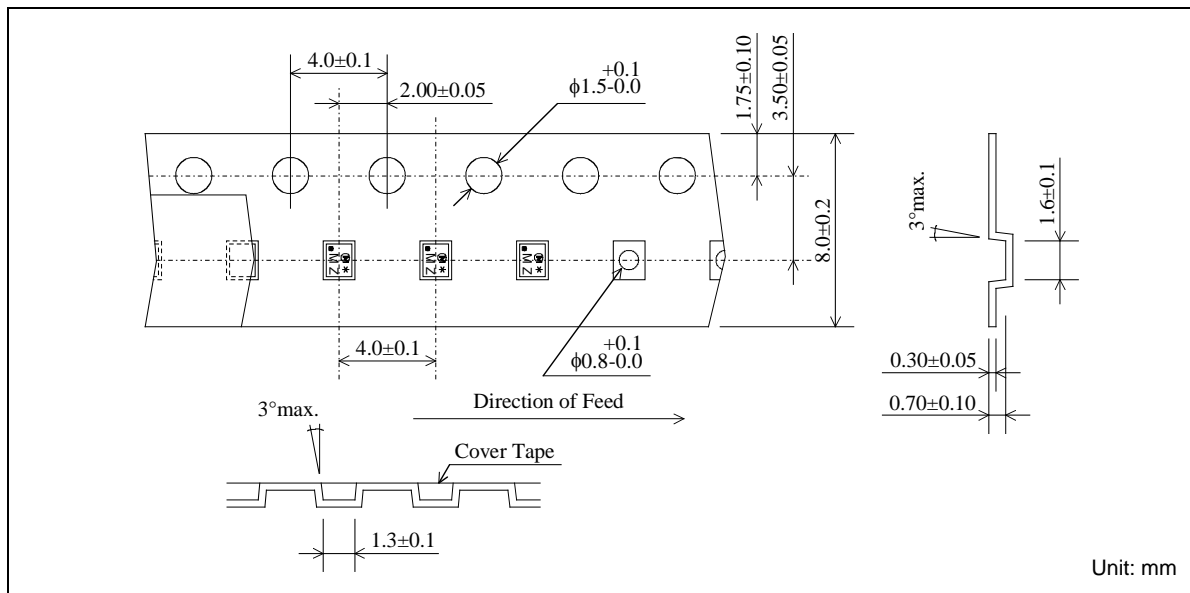

Dimensions of Tape

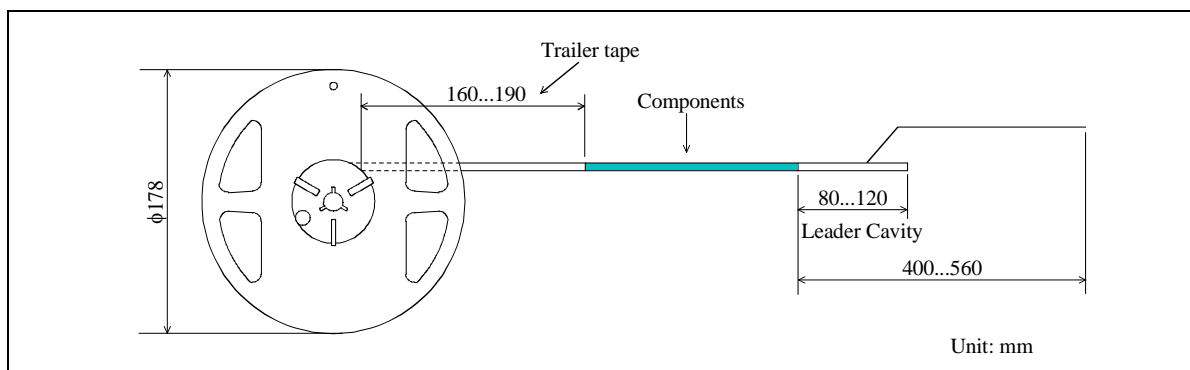

Dimensions of Reel

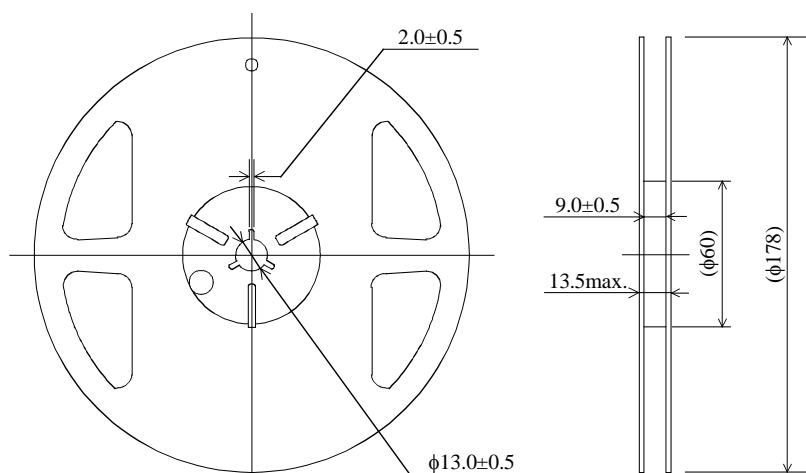

SAFEA942MFL0F00R14 ... 4000pcs/reel
SAFEA942MFL0F00R12 ... 2000pcs/reel

SAW FILTER FOR GSM900/Band8 Rx

Murata part number: SAFEA942MFL0F00

■ RoHS Compliance

This component is compliant with RoHS directive.

This component was always RoHS compliant from the first date of manufacture.

• Caution - Limitation of Applications

This product is intended for the following applications only; however, please do not use this product in these applications where defects might directly cause damage to a third party's life, body or property.

- a. Mobile Telephone
- b. Cordless phone (except for Automotive use)
- c. PC (Including Notebook PC, Netbook PC, Tablet)
- d. Game
- e. Camera (except for Business/security use)
- f. Set Top Box
- g. Electronic dictionary
- h. Digital audio equipment

• This catalog is for reference only and not an official product specification document, therefore, please review and approve our official product specification before ordering this product.