

MAU100 Series

1W, Miniature SIP, Single & Dual Output DC/DC Converters

Key Features

- Efficiency up to 81%
- 1000VDC Isolation
- MTBF > 2,000,000 Hours
- Low Cost
- Input 5, 12, 15 and 24VDC
- Output 3.3, 5, 9, 12, 15, ± 5 , ± 9 , ± 12 and ± 15 VDC
- Temperature Performance -40°C to $+85^{\circ}\text{C}$
- UL 94V-0 Package Material
- Internal SMD Construction
- Industry Standard Pinout

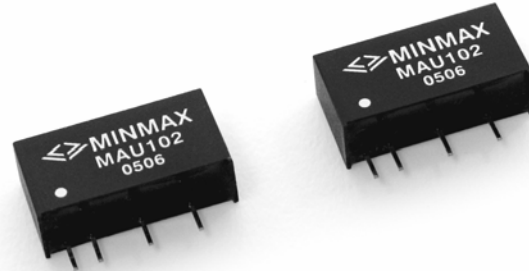

Minmax's MAU100 1W DC/DC's are specially designed to provide the optimum cost/benefit power solution in a miniature SIP package.

The series consists of 33 models with input voltages of 5V, 12V, 15V and 24VDC which offers standard output voltages of 3.3V, 5V, 9V, 12V, 15V, ± 5 V, ± 9 V, ± 12 V and ± 15 VDC for a wide choice.

The MAU100 series is an excellent selection for a variety of applications including distributed power systems, mixed analog/digital subsystems, portable test equipments, local power networks and battery backed systems.

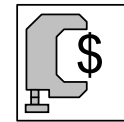

Low Cost

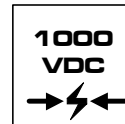

I/O Isolation

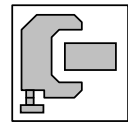

Low Profile

Block Diagram

Single Output

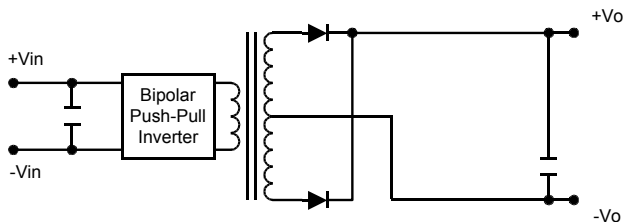

Dual Output

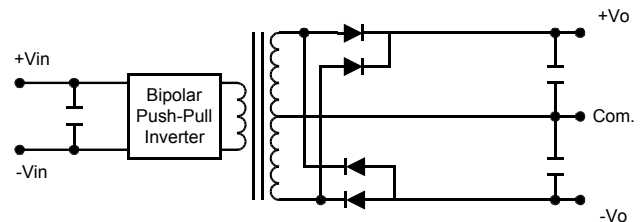

Model Selection Guide

| Model Number | Input Voltage | Output Voltage | Output Current | | Input Current | | Load Regulation | Efficiency |
|--------------|---------------------|---------------------|----------------|------|---------------|-----------|-----------------|------------|
| | | | Max. | Min. | @Max. Load | @No Load | | |
| | VDC | VDC | mA | mA | mA (Typ.) | mA (Typ.) | %(Max.) | %(Typ.) |
| MAU101 | 5 (4.5 ~ 5.5) | 3.3 | 260 | 5 | 235 | 30 | 10 | 73 |
| MAU102 | | 5 | 200 | 4 | 281 | | 10 | 71 |
| MAU103 | | 9 | 110 | 2 | 260 | | 8 | 76 |
| MAU104 | | 12 | 84 | 1.5 | 258 | | 7 | 78 |
| MAU105 | | 15 | 67 | 1 | 258 | | 7 | 78 |
| MAU106 | | ±5 | ±100 | ±2 | 278 | | 10 | 72 |
| MAU107 | | ±9 | ±56 | ±1 | 262 | | 8 | 77 |
| MAU108 | | ±12 | ±42 | ±0.8 | 258 | | 7 | 78 |
| MAU109 | | ±15 | ±34 | ±0.7 | 258 | | 7 | 79 |
| MAU111 | | 12 (10.8 ~ 13.2) | 3.3 | 260 | 5 | | 96 | 12 |
| MAU112 | 5 | | 200 | 4 | 114 | 8 | 73 | |
| MAU113 | 9 | | 110 | 2 | 106 | 5 | 78 | |
| MAU114 | 12 | | 84 | 1.5 | 105 | 5 | 80 | |
| MAU115 | 15 | | 67 | 1 | 104 | 5 | 80 | |
| MAU116 | ±5 | | ±100 | ±2 | 113 | 8 | 74 | |
| MAU117 | ±9 | | ±56 | ±1 | 106 | 5 | 79 | |
| MAU118 | ±12 | | ±42 | ±0.8 | 104 | 5 | 81 | |
| MAU119 | ±15 | | ±34 | ±0.7 | 105 | 5 | 81 | |
| MAU121 | 24 (21.6 ~ 26.4) | | 3.3 | 260 | 5 | 49 | 7 | |
| MAU122 | | 5 | 200 | 4 | 59 | 8 | | 71 |
| MAU123 | | 9 | 110 | 2 | 54 | 5 | | 76 |
| MAU124 | | 12 | 84 | 1.5 | 54 | 5 | | 78 |
| MAU125 | | 15 | 67 | 1 | 53 | 5 | | 79 |
| MAU126 | | ±5 | ±100 | ±2 | 58 | 8 | | 72 |
| MAU127 | | ±9 | ±56 | ±1 | 55 | 5 | | 76 |
| MAU128 | | ±12 | ±42 | ±0.8 | 53 | 5 | | 79 |
| MAU129 | | ±15 | ±34 | ±0.7 | 53 | 5 | | 80 |
| MAU151 | | 15 (13.5 ~ 16.5) | 5 | 200 | 4 | 93 | | 11 |
| MAU152 | 12 | | 84 | 1.5 | 85 | 5 | 79 | |
| MAU153 | 15 | | 67 | 1 | 85 | 5 | 79 | |
| MAU154 | ±5 | | ±100 | ±2 | 93 | 8 | 72 | |
| MAU155 | ±12 | | ±42 | ±0.8 | 85 | 5 | 80 | |
| MAU156 | ±15 | | ±34 | ±0.7 | 85 | 5 | 80 | |

Absolute Maximum Ratings

| Parameter | Min. | Max. | Unit | |
|--|--------------------|------|------|-----|
| Input Surge Voltage (1000 mS) | 5VDC Input Models | -0.7 | 9 | VDC |
| | 12VDC Input Models | -0.7 | 18 | VDC |
| | 15VDC Input Models | -0.7 | 18 | VDC |
| | 24VDC Input Models | -0.7 | 30 | VDC |
| Lead Temperature (1.5mm from case for 10 Sec.) | --- | 260 | °C | |
| Internal Power Dissipation | --- | 450 | mW | |

Exceeding the absolute maximum ratings of the unit could cause damage. These are not continuous operating ratings.

Notes :

1. Specifications typical at Ta=+25°C, resistive load, nominal input voltage, rated output current unless otherwise noted.
2. Ripple & Noise measurement bandwidth is 0-20 MHz.
3. These power converters require a minimum output loading to maintain specified regulation.
4. Operation under no-load conditions will not damage these modules; however, they may not meet all specifications listed.
5. All DC/DC converters should be externally fused at the front end for protection.
6. Other input and output voltage may be available, please contact factory.
7. Specifications subject to change without notice.

MAU100 Series

Environmental Specifications

| Parameter | Conditions | Min. | Typ. | Max. | Unit |
|-----------------------|---------------------|------|------|------|------|
| Operating Temperature | Ambient | -40 | --- | +85 | °C |
| Operating Temperature | Case | -40 | --- | +90 | °C |
| Storage Temperature | | -40 | --- | +125 | °C |
| Humidity | | --- | --- | 95 | % |
| Cooling | Free-Air Convection | | | | |

Input Specifications

| Parameter | Model | Min. | Typ. | Max. | Unit |
|--------------------------------|------------------|--------------------|------|------|------|
| Input Voltage Range | 5V Input Models | 4.5 | 5 | 5.5 | VDC |
| | 12V Input Models | 10.8 | 12 | 13.2 | |
| | 15V Input Models | 13.5 | 15 | 16.5 | |
| | 24V Input Models | 21.6 | 24 | 26.4 | |
| Reverse Polarity Input Current | All Models | --- | --- | 0.3 | A |
| Input Filter | | Internal Capacitor | | | |

Output Specifications

| Parameter | Conditions | Min. | Typ. | Max. | Unit |
|-------------------------|-----------------------------|---------------------------|-------|-------|--------|
| Output Voltage Accuracy | | --- | ±1.0 | ±3.0 | % |
| Output Voltage Balance | Dual Output, Balanced Loads | --- | ±0.1 | ±1.0 | % |
| Line Regulation | For Vin Change of 1% | --- | ±1.2 | ±1.5 | % |
| Load Regulation | Io=20% to 100% | See Model Selection Guide | | | % |
| Ripple & Noise (20MHz) | | --- | 50 | 75 | mV P-P |
| Ripple & Noise (20MHz) | Over Line, Load & Temp. | --- | --- | 150 | mV P-P |
| Ripple & Noise (20MHz) | | --- | --- | 5 | mV rms |
| Over Load | | 120 | --- | --- | % |
| Temperature Coefficient | | --- | ±0.01 | ±0.02 | %/°C |
| Output Short Circuit | 0.5 Second Max. | | | | |

General Specifications

| Parameter | Conditions | Min. | Typ. | Max. | Unit |
|-------------------------|-------------------------------------|------|------|------|---------|
| Isolation Voltage Rated | 60 Seconds | 1000 | --- | --- | VDC |
| Isolation Voltage Test | Flash Tested for 1 Second | 1100 | --- | --- | VDC |
| Isolation Resistance | 500VDC | 1000 | --- | --- | MΩ |
| Isolation Capacitance | 100KHz, 1V | --- | 60 | 100 | pF |
| Switching Frequency | | 70 | 100 | 120 | KHz |
| MTBF | MIL-HDBK-217F @ 25°C, Ground Benign | 2000 | --- | --- | K Hours |

Capacitive Load

| Models by Vout | 3.3V | 5V | 9V | 12V | 15V | ±5V # | ±9V # | ±12V # | ±15V # | Unit |
|-------------------------|------|-----|-----|-----|-----|-------|-------|--------|--------|------|
| Maximum Capacitive Load | 220 | 220 | 220 | 220 | 220 | 100 | 100 | 100 | 100 | uF |

For each output

Input Fuse Selection Guide

| 5V Input Models | 12V Input Models | 15V Input Models | 24V Input Models |
|------------------------|------------------------|------------------------|------------------------|
| 500mA Slow - Blow Type | 200mA Slow - Blow Type | 150mA Slow - Blow Type | 100mA Slow - Blow Type |

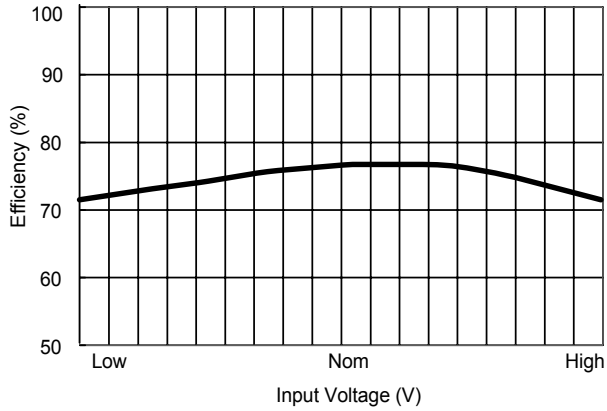

Efficiency vs Input Voltage (Single Output)

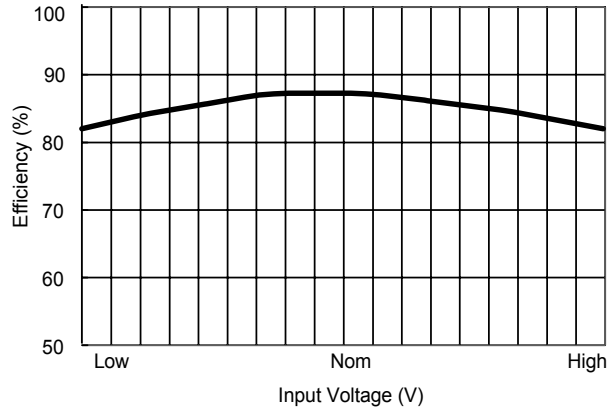

Efficiency vs Input Voltage (Dual Output)

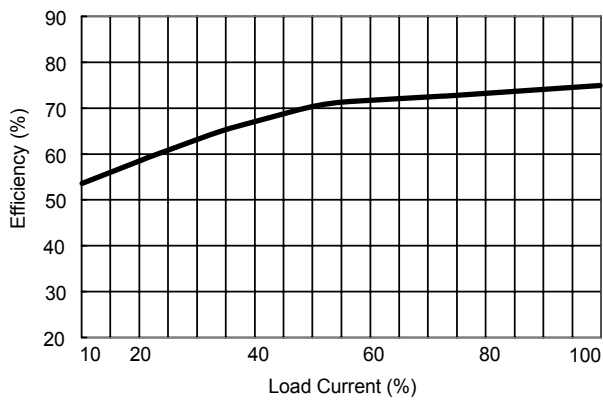

Efficiency vs Output Load (Single Output)

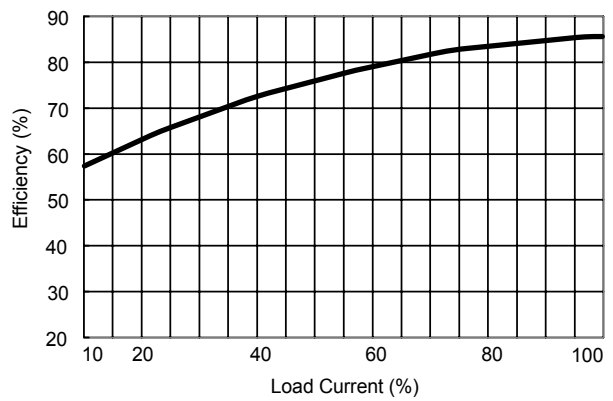

Efficiency vs Output Load (Dual Output)

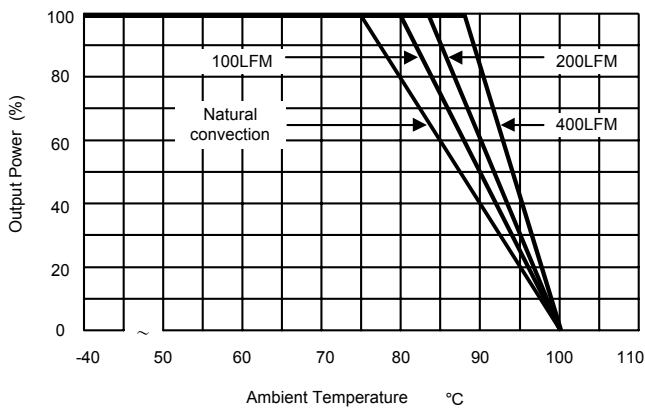

Derating Curve (3.3V, 5V & ±5V)

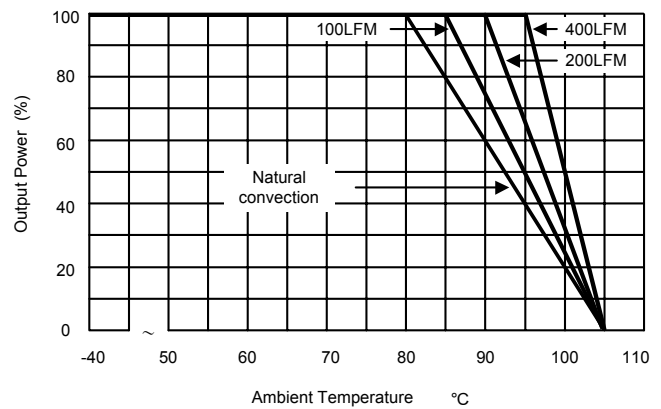

Derating Curve (all other output)

Test Configurations

Input Reflected-Ripple Current Test Setup

Input reflected-ripple current is measured with an inductor L_{in} (4.7 μ H) and C_{in} (220 μ F, ESR < 1.0 Ω at 100 KHz) to simulate source impedance.

Capacitor C_{in} , offsets possible battery impedance.

Current ripple is measured at the input terminals of the module, measurement bandwidth is 0–500 KHz.

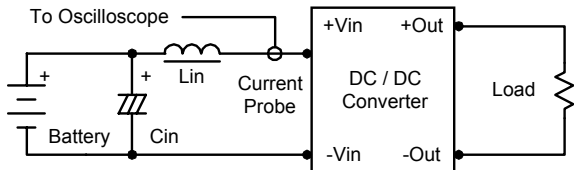

Peak-to-Peak Output Noise Measurement Test

Use a C_{out} 0.33 μ F ceramic capacitor.

Scope measurement should be made by using a BNC socket, measurement bandwidth is 0–20 MHz. Position the load between 50 mm and 75 mm from the DC/DC Converter.

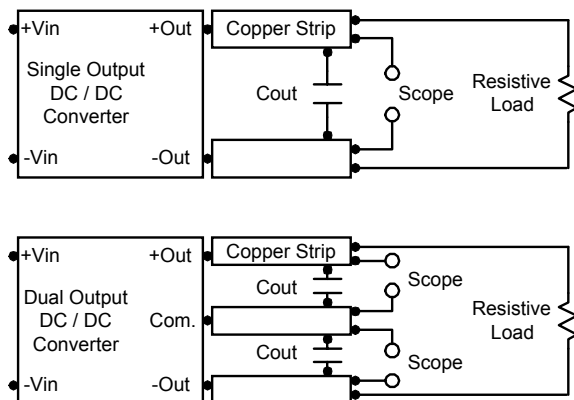

Design & Feature Considerations

Maximum Capacitive Load

The MAU100 series has limitation of maximum connected capacitance at the output.

The power module may be operated in current limiting mode during start-up, affecting the ramp-up and the startup time.

For optimum performance we recommend 100 μ F maximum capacitive load for dual outputs and 220 μ F capacitive load for single outputs.

The maximum capacitance can be found in the data sheet.

Input Source Impedance

The power module should be connected to a low ac-impedance input source. Highly inductive source impedances can affect the stability of the power module.

In applications where power is supplied over long lines and output loading is high, it may be necessary to use a capacitor at the input to ensure startup.

Capacitor mounted close to the power module helps ensure stability of the unit, it is commended to use a good quality low Equivalent Series Resistance (ESR < 1.0 Ω at 100 KHz) capacitor of a 2.2 μ F for the 5V input devices, a 1.0 μ F for the 12V, 15V input devices and a 0.47 μ F for the 24V devices.

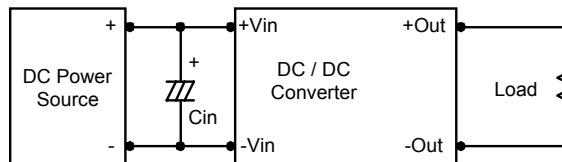

Output Ripple Reduction

A good quality low ESR capacitor placed as close as practicable across the load will give the best ripple and noise performance.

To reduce output ripple, it is recommended to use 1.0 μ F capacitors at the output.

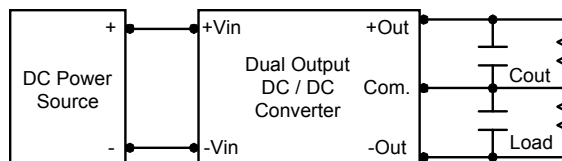
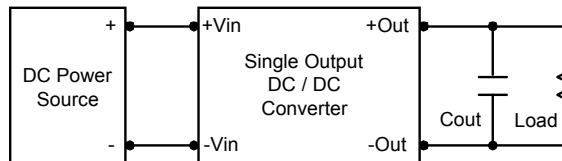

Thermal Considerations

Many conditions affect the thermal performance of the power module, such as orientation, airflow over the module and board spacing. To avoid exceeding the maximum temperature rating of the components inside the power module, the case temperature must be kept below 90°C.

The derating curves are determined from measurements obtained in an experimental apparatus.

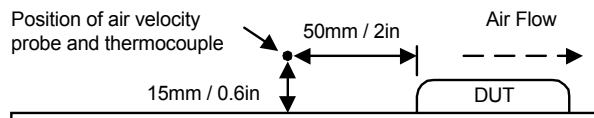

Mechanical Dimensions

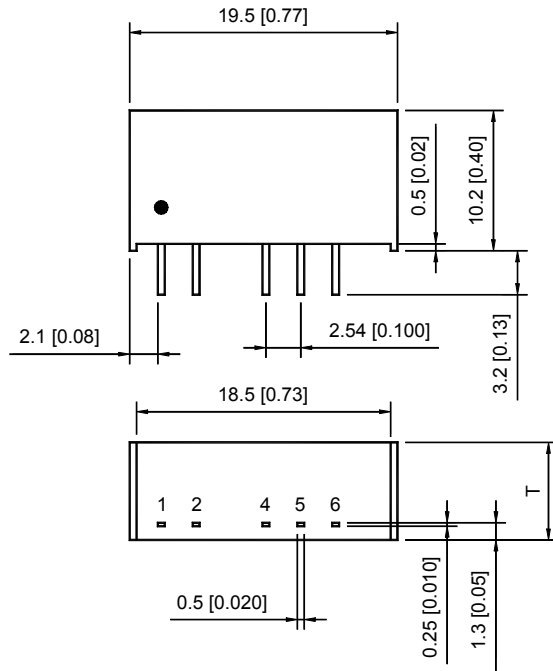

T: 6.1(0.24) for 5V&12V Input Models
 T: 7.1(0.28) for 15V&24V Input Models

| Tolerance | Millimeters | Inches |
|-----------|-------------|-------------|
| | X.X±0.25 | X.XX±0.01 |
| | X.XX±0.13 | X.XXX±0.005 |
| Pin | ±0.05 | ±0.002 |

Connecting Pin Patterns

Top View (2.54 mm / 0.1 inch grids)

Single Output

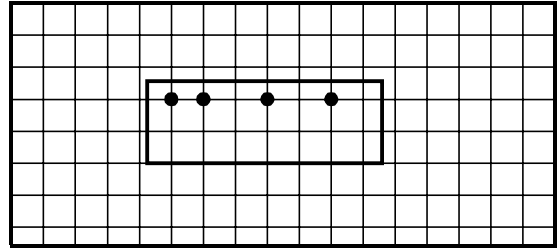

Dual Output

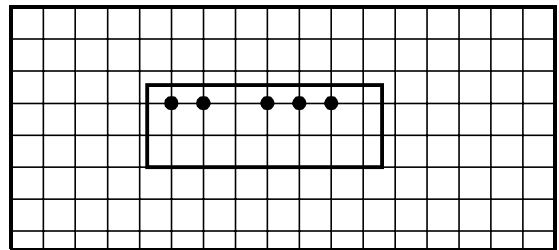

Pin Connections

| Pin | Single Output | Dual Output |
|-----|---------------|-------------|
| 1 | +Vin | +Vin |
| 2 | -Vin | -Vin |
| 4 | -Vout | -Vout |
| 5 | No Pin | Common |
| 6 | +Vout | +Vout |

Physical Characteristics

Case Size : 19.5×6.1×10.2 mm
 (5 & 12V Input) : 0.77×0.24×0.40 inches

Case Size : 19.5×7.1×10.2 mm
 (15 & 24V Input) : 0.77×0.28×0.40 inches

Case Material : Non-Conductive Black Plastic

Weight : 2.2g (5 & 12V Input)
 : 2.6g (15 & 24V Input)

The MAU100 converter is encapsulated in a low thermal resistance molding compound that has excellent resistance/electrical characteristics over a wide temperature range or in high humidity environments. The encapsulant and unit case are both rated to UL 94V-0 flammability specifications. Leads are tin plated for improved solderability.