

多層片式陶瓷電容器

MULTILAYER CHIP CERAMIC CAPACITOR

■ 通用型COG/COH片容

通用型COG片容屬於 I 類高頻電容器，其電容量非常穩定，幾乎不隨溫度、電壓和時間的變化而變化。尤其適用於高頻電子線路。

● 特性

- * 具有高的電容量穩定性,在-55℃ ~ 125℃ 工作範圍內,其溫度系數為 $0 \pm 30\text{ppm}/^\circ\text{C}$ 、 $0 \pm 60\text{ppm}/^\circ\text{C}$ 。
- * 疊層獨石結構,具有高可靠性。
- * 優良的焊接性和耐焊性,適用於回流焊和波峰焊。

● 應用

- * 適用於各種高頻電子線路。

● 產品規格型號表示方法

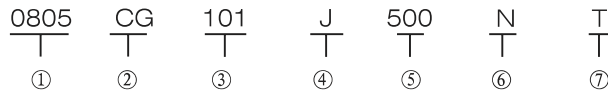

① 尺寸		
型號	英制(英寸)	公制(毫米)
0402	0.04 × 0.02	1.00 × 0.50
0603	0.06 × 0.03	1.60 × 0.80
0805	0.08 × 0.05	2.00 × 1.25
1206	0.12 × 0.06	3.20 × 1.60

② 介質種類	
代碼	介質材料
CG	COG或NPO
CH	COH

③ 標稱電容量(PF)	
表示方式	實際值
100	10×10^0
101	10×10^1
102	10×10^2

④ 誤差級別	
代碼	誤差
J	± 5.00%
G	± 2.00%
C	± 0.25PF
B	± 0.10PF
D	± 0.50PF

⑤ 工作電壓	
表示方法	實際電壓
6R3	6.3V
100	10V
250	25V
500	50V

⑥ 端頭類別	
表示方法	端頭材料
S	純銀端頭
C	純銅端頭
N	三層電鍍端頭 (銀或銅層/鎳層/錫層)

⑦ 包裝方式	
表示方法	包裝
無標記	袋裝散包裝
T	編帶包裝
B	塑料盒散包裝

● 外形尺寸

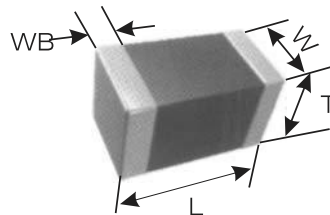

規格型號		尺寸(mm)			
英制表示	公制表示	L	W	T	WB
0402	1005	1.00 ± 0.05	0.50 ± 0.05	0.50 ± 0.05	0.25 ± 0.10
0603	1608	1.60 ± 0.10	0.80 ± 0.10	0.80 ± 0.10	0.30 ± 0.10
0805	2012	2.00 ± 0.20	1.25 ± 0.20	0.80 ± 0.10 1.00 ± 0.10 1.25 ± 0.20	0.50 ± 0.25
1206	3216	3.20 ± 0.30	1.60 ± 0.20	0.80 ± 0.10 1.00 ± 0.10 1.25 ± 0.20	0.50 ± 0.25



■ COG/COH MLCC for general-use

COG MLCC for General-use is class I high frequency capacitor, its capacitance is very stable, almost will not change along with the temperature, voltage and time. Specially be suitable for high frequency circuits.

● Features

- * The capacitance is very stable, its operating temperature is -55℃~125℃, within the range, the temperature coefficient is 0±30ppm/℃, 0±60ppm/℃.
- * It has multi-layer monolithic structure, has high reliability.
- * It has good solderability and soldering resistance, suitable for flow/reflow soldering.

● Application

- * It is suitable for all kinds of high frequency circuits.

● Product Part Number Expression

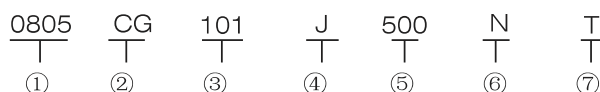

①Dimensions		
Type	British (Inch)	Metric (mm)
0402	0.04×0.02	1.00×0.50
0603	0.06×0.03	1.60×0.80
0805	0.08×0.05	2.00×1.25
1206	0.12×0.06	3.20×1.60

②Dielectric Type	
Code	Dielectric
CG	COG or NPO
CH	COH

③Normal Capacitance(PF)	
Expression Method	Actual Value
100	10×10 ⁰
101	10×10 ¹
102	10×10 ²

④Capacitance Tolerance	
Code	Tolerance
J	±5.00%
G	±2.00%
C	±0.25PF
B	±0.10PF
D	±0.50PF

⑤Rated Voltage	
Expression Method	Actual Value
500	50V
250	25V
101	100V
201	200V

⑥Termination Type	
Expression Method	Termination Material
S	Pure Silver
C	Pure Copper
N	Three Layers Plating Terminal (Silver or Copper layer/ Nickel layer /Tin layer)

⑦Package Method	
Expression Method	Packaging
No Mark	Bulk Packaging in a Bag
T	Taping Packaging
B	Bulk Plastic Box Packaging

● Outside Dimension

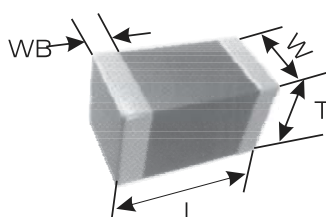

Type		Dimension (mm)			
British Expression	Metric Expression	L	W	T	WB
0402	1005	1.00±0.05	0.50±0.05	0.50±0.05	0.25±0.10
0603	1608	1.60±0.10	0.80±0.10	0.80±0.10	0.30±0.10
0805	2012	2.00±0.20	1.25±0.20	0.80±0.10 1.00±0.10 1.25±0.20	0.50±0.25
1206	3216	3.20±0.30	1.60±0.20	0.80±0.10 1.00±0.10 1.25±0.20	0.50±0.25

多層片式陶瓷電容器

MULTILAYER CHIP CERAMIC CAPACITOR

● 電容量範圍

項目	通用型COG/COH片容																			
	0402					0603					0805					1206				
尺寸																				
工作電壓	6.3V	10V	16V	25V	50V	6.3V	10V	16V	25V	50V	6.3V	10V	16V	25V	50V	6.3V	10V	16V	25V	50V
電容量																				
0.5PF																				
1PF																				
2PF																				
3PF																				
4PF																				
5PF																				
6PF																				
7PF																				
10PF																				
22PF																				
33PF																				
47PF																				
68PF																				
100PF																				
120PF																				
150PF																				
180PF																				
220PF																				
330PF																				
470PF																				
560PF																				
680PF																				
1000PF																				
2200PF																				
2700PF																				
3300PF																				
4700PF																				
5600PF																				
6800PF																				
10nF																				
12nF																				
15nF																				
22nF																				
27nF																				
33nF																				
47nF																				



■ Capacitance Range

Item	COG/COH MLCC for general-use																			
	0402					0603					0805					1206				
Rated Voltage	6.3V	10V	16V	25V	50V	6.3V	10V	16V	25V	50V	6.3V	10V	16V	25V	50V	6.3V	10V	16V	25V	50V
Capacitance																				
0.5PF																				
1PF																				
2PF																				
3PF																				
4PF																				
5PF																				
6PF																				
7PF																				
10PF																				
22PF																				
33PF																				
47PF																				
68PF																				
100PF																				
120PF																				
150PF																				
180PF																				
220PF																				
330PF																				
470PF																				
560PF																				
680PF																				
1000PF																				
2200PF																				
2700PF																				
3300PF																				
4700PF																				
5600PF																				
6800PF																				
10nF																				
12nF																				
15nF																				
22nF																				
27nF																				
33nF																				
47nF																				

多層片式陶瓷電容器
MULTILAYER CHIP CERAMIC CAPACITOR

■ 通用型COG、COH、PH~SL可靠性測試方法

編號	項目	標準		測試方法
		通用型COG、COH片容	通用型PH、RH、SH、TH、UJ、SL片容	
1	工作溫度範圍	-55℃ ~ 125℃	-55℃ ~ 85℃	
2	外觀	1. 瓷體顏色一致性好。 2. 芯片無可見損傷,光滑平整。 3. 瓷體無外露電極,裂痕,孔洞。 4. 端電極無裂痕,孔洞,磨損及表面氧化等。 5. 端電極應無延伸現象或延伸部分不超過端頭寬度的一半。		※在 ≥ 10 × 倍以上的顯微鏡下觀察。
3	尺寸	在規定尺寸範圍內		※使用千分尺或游標卡尺。
4	電容量	在規定偏差範圍內		※測試儀器:HP4278A電橋、HP4284電橋。 ※測試條件: 1.測試溫度: 25℃ ± 5℃, 濕度:30% ~ 75%。 2.測試電壓:1.0 ± 0.2V。 3.測試頻率:C<1000PF,1.0 ± 0.1MHz; C ≥ 1000PF,1.0 ± 0.1KHZ
5	損耗因數(D.F.)	Cr < 5PF < 0.56% 5PF ≤ Cr < 50PF 1.5 [(150/Cr)+7] × 10 ⁻⁴ Cr ≥ 50PF < 0.15%		
6	絕緣電阻 (I.R.)	C ≤ 10nF Ri ≥ 5 × 10 ¹⁰ Ω C > 10nF Ri · Cr ≥ 500s		※測試儀器:絕緣電阻測試儀(如:SF2511絕緣測試機)。 ※測試方法:施加額定工作電壓,在60 ± 5 秒內測量絕緣電阻。
7	耐電壓強度	>3×額定工作電壓		※施加3倍額定工作電壓,持續 60 ± 1 秒,未出現擊穿現象并且充電 / 放電電流低於50mA。
8	電容量溫度特性	在工作溫度範圍內符合電容器特性溫度系數要求		※首先進行預處理:進行 150+0/-10℃熱處理 60 ± 5 分鐘,然后在室溫條件下放置 24 ± 2 小時。 ※在 -55 ~ 125℃或者-55 ~ 85℃範圍內測試電容量,其電容值相對於25℃時數值的變化率應在規定範圍內。
9	可焊性	75% 端電極覆蓋錫		※將電容器浸在乙醇和松香溶液中。然後浸入 有鉛235 ± 5℃ (無鉛245 ± 5℃) 的混合焊錫 溶液 2 ± 0.5 秒。浸入速度: 25 ± 2.5mm/秒。
10	耐焊接熱	外觀	無明顯缺陷	※首先進行預處理:進行 150+0/-10℃熱處理 60 ± 5 分鐘,然后在室溫條件下放置 24 ± 2 小時。 ※然後按下表預熱電容器。將電容器浸入 260 ± 5℃ 的混合焊錫溶液10 ± 1 秒。再在室溫條件下放置24 ± 2 小時,然後進行測量。 浸入速度: 25 ± 2.5mm/秒。 ※預熱條件如下:
		電容量變化率	≤ ± 5% 或 ± 0.5PF取兩者中最大的	
		D.F.	同初始標準	
		I.R.	同初始標準	

階段	溫度	時間
1	100℃—120℃	1分鐘
2	170℃—200℃	1分鐘



• General COG、COH、PH~SL MLCC reliability test method

Number	Item	Standard		Test Method
		COG、COH MLCC for General-use	PH, RH, SH, TH, UJ, SL MLCC for General-use	
1	Operating Temperature Range	-55℃~125℃	-55℃~85℃	
2	Appearance	1.Good ceramic body color continuity. 2.The chips have no visual damages and must be very smooth. 3.No exposed inner- electrode, no cracks or holes. 4.The outer electrode should have no cracks, holes, damages or surface oxidation. 5.Outer electrode no prolongation or the prolongation is less than half of that of the termination width.		※Check by using microscope ≥10×.
3	Dimensions	Within the specified dimensions		※Using micrometer or vernier calipers
4	Capacitance	Within the specified tolerance		※Measuring Equipments:HP4278 capacitance meter,HP4284 capacitance,
5	Dissipation Factor (DF)	Cr<5PF ≤0.56% 5PF≤Cr<50PF 1.5 [(150/Cr)+7] × 10 ⁻⁴ Cr≥50PF ≤0.15%		※Measuring Conditions: 1.Measuring Temperature:25℃±5℃.Humidity: 30%~75%. 2.Measuring Voltage:1.0±0.2V. 3.Measuring Frequency:C<1000PF, 1.0±0.1MHz C≥1000PF, 1.0±0.1KHz
6	Insulation Resistance	C ≤ 10nF Ri ≥ 5 × 10 ¹⁰ Ω C > 10nF Ri · Cr ≥ 500s		※Measuring Equipment:Insulation resistance meter (such as Sf2511 insulation resistance). ※Measuring Method:Must measure at rated voltage, and measure the IR within 60±5 seconds.
7	Withstanding Voltage	>3x rated continuous working voltage		※Must measure at 3 times rated voltage, dwell time: 60±1 seconds, no short and the changing/discharging current less than 50mA.
8	Capacitance Temperature Characteristic	Must meet the capacitor character temperature coefficient requirements within the operating temperature range.		※First, pre-heat: heat treat 60±5 minutes at 150+0/-10℃, then set it for 24±2 hours at room temperature. ※Measure the capacitance at -55~125℃ or -55~85℃, the capacitance change ratio comparing to that of 25℃ must be within the specified range.
9	Solderability	Tin coverage should be 75% of the outer electrode		※Dip the capacitor into ethanol or colophony solution, and then dip it into 235±5℃ (or 245±5℃ leadless eutectic solder solution) eutectic solder solution hanving lead for 2±0.5 seconds. Dipping speed: 25±2.5mm/second.
10	Resistance to Soldering	Appearance	No defects visible	※First pre-heat: heat treat for 60±5 minutes at 150+0/-10℃, then set it for 24±2 hours at room temperature. ※Then pre-heat the capacitance according to the following chart. Dip the capacitor into 260±5℃ eutectic solder solution for 10±1 seconds. Then set it for 24±2 hours at room temperature, then measure. Dipping speed: 25±2.5mm/second. ※Preheat conditions:
		Cap. Change ratio	≤±5%or±0.5PF (whichever is larger)	
		DF	Same as original spec	
		IR	Same as original spec	

Stage	Temperature	Time
1	100℃—120℃	1minute
2	170℃—200℃	1minute

多層片式陶瓷電容器 MULTILAYER CHIP CERAMIC CAPACITOR

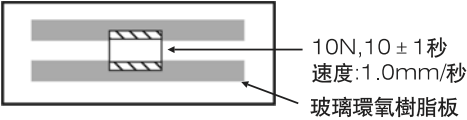
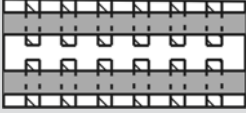
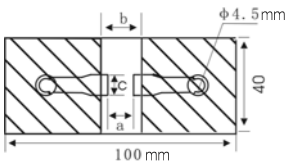
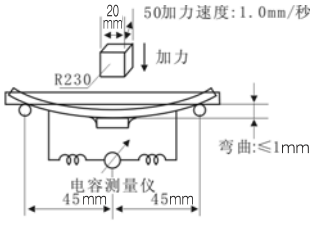
編號	項目	標準		測試方法																						
11	端電極結合強度	不應出現端頭脫落或其它缺陷。		<p>※使用混合焊錫將電容器焊接在圖 1 中所示的測試夾具(玻璃環氧樹脂板) 上。然後沿箭頭方向施加 10N 的力。焊接應利用烙鐵或使用回流焊方法進行，而且應謹慎作業，以使焊接均勻且不會出現熱衝擊等不良現象。</p>  <p>10N, 10 ± 1 秒 速度: 1.0mm/秒 玻璃環氧樹脂板</p> <p>圖 1</p>																						
12	耐振動性	外觀	無明顯缺陷	<p>※將電容器焊接在測試夾具(玻璃環氧樹脂板) 上。電容器應進行簡諧運動，其總幅值為 1.5mm，頻率在近似 10—55Hz 之間均勻變化。頻率範圍(從 10 至 55Hz 再返回 10Hz) 應在約 1 分鐘內完成。振動應在三個相互垂直方向各進行 2 小時(總計 6 小時) 。</p>  <p>圖 2</p>																						
		電容量	在規定偏差範圍內																							
		D.F.	同初始標準																							
13	抗彎曲性	不應出現裂縫或其他缺陷。		<p>※使用混合焊錫將電容器焊接在圖 3 中所示的測試夾具(玻璃環氧樹脂板) 上，然後在圖 4 所示的方向加力。焊接應利用烙鐵或使用回流焊方法進行，而且應謹慎作業，以使焊接均勻且不會出現熱衝擊等不良現象。</p>  <p>圖 3</p>  <p>圖 4</p> <table border="1" data-bbox="906 1563 1257 1704"> <thead> <tr> <th rowspan="2">L×W (mm)</th> <th colspan="4">尺寸 (mm)</th> </tr> <tr> <th>a</th> <th>b</th> <th>c</th> <th>d</th> </tr> </thead> <tbody> <tr> <td>4.5×2.0</td> <td>3.5</td> <td>7.0</td> <td>2.4</td> <td rowspan="3">1.0</td> </tr> <tr> <td>4.5×3.2</td> <td>3.5</td> <td>7.0</td> <td>3.7</td> </tr> <tr> <td>5.7×6.3</td> <td>4.5</td> <td>8.0</td> <td>5.6</td> </tr> </tbody> </table>	L×W (mm)	尺寸 (mm)				a	b	c	d	4.5×2.0	3.5	7.0	2.4	1.0	4.5×3.2	3.5	7.0	3.7	5.7×6.3	4.5	8.0	5.6
L×W (mm)	尺寸 (mm)																									
	a	b	c	d																						
4.5×2.0	3.5	7.0	2.4	1.0																						
4.5×3.2	3.5	7.0	3.7																							
5.7×6.3	4.5	8.0	5.6																							
14	溫度循環	外觀	無缺陷或異常	<p>※首先進行預處理：進行 150+0/-10℃ 熱處理 60 ± 5 分鐘，然後在室溫條件下放置 24 ± 2 小時。</p> <p>※按照下表中列出的四種熱處理方法執行五次循環。</p> <p>在室溫條件下放置 24 ± 2 小時，然後進行測量。</p>																						

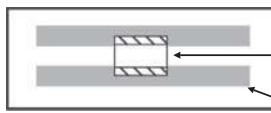
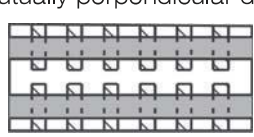
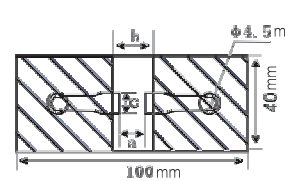
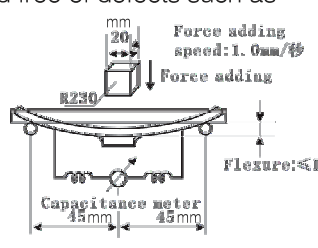
Number	Items	Standard		Test Method																						
11	Adhesive Strength of Termination	No removal of the terminations or other defect shall occur		<p>※Solder the capacitor to the test jig (glass epoxy resin board) shown in Fig.1 using a eutectic solder. Then apply a 10N force in the direction shown as the arrowhead. The soldering shall be done either with an iron or using the reflow method and shall be conducted with care so that the soldering is uniform and free of defects such as heat shock, etc.</p>  <p>10N, 10±1s Speed: 1.0mm/s Gls epoxy resinboard</p> <p>Fig.1</p>																						
12	Vibration Resistance	Appearance	No defects or abnormalities	<p>※Solder the capacitor to the test jig (glass epoxy resin board). The capacitor should be subjected to a simple harmonic motion having a total amplitude of 1.5mm, the frequency being varied uniformly between the approximate limits of 10 and 55Hz, shall be traversed (from 10 Hz to 55 Hz then 10 Hz again) in approximately 1 minute. This motion shall be applied for a period of 2 hours in each 3 mutually perpendicular directions (total is 6 hours).</p>  <p>Fif.2</p>																						
		Capacitance	Within the specified tolerance range																							
		DF	Same as original spec																							
13	Bending Resistance	No cracks or other defects shall occur		<p>※Solder the capacitor to the test jig (glass epoxy resin board) shown in Fig.3 using a eutectic solder. Then apply a 10N force in the direction shown as Fig.4. The soldering shall be done either with an iron or using the reflow method and shall be conducted with care so that the soldering is uniform and free of defects such as heat shock, etc.</p>  <p>Fig. 3</p>  <p>Fig. 4</p> <table border="1" data-bbox="813 1590 1165 1747"> <thead> <tr> <th rowspan="2">L×W (mm)</th> <th colspan="4">Dimension</th> </tr> <tr> <th>a</th> <th>b</th> <th>c</th> <th>d</th> </tr> </thead> <tbody> <tr> <td>4.5×2.0</td> <td>3.5</td> <td>7.0</td> <td>2.4</td> <td rowspan="3">1.0</td> </tr> <tr> <td>4.5×3.2</td> <td>3.5</td> <td>7.0</td> <td>3.7</td> </tr> <tr> <td>5.7×6.3</td> <td>4.5</td> <td>8.0</td> <td>5.6</td> </tr> </tbody> </table>	L×W (mm)	Dimension				a	b	c	d	4.5×2.0	3.5	7.0	2.4	1.0	4.5×3.2	3.5	7.0	3.7	5.7×6.3	4.5	8.0	5.6
L×W (mm)	Dimension																									
	a	b	c	d																						
4.5×2.0	3.5	7.0	2.4	1.0																						
4.5×3.2	3.5	7.0	3.7																							
5.7×6.3	4.5	8.0	5.6																							
14	Temperature Cycle	Appearance	No defects or abnormalities	<p>※Pre-treatment: Heat-treat the capacitor for 60±5minutes at 150+0/-10℃, then set it for 24±2 hours at room temperature.</p> <p>※Perform five cycles according to the four heat treatments listed in the following table. Set it for 24±2 hours at room temperature, then measure.</p>																						

多层片式陶瓷电容器

MULTILAYER CHIP CERAMIC CAPACITOR

編號	項目	標準		測試方法															
14	溫度循環	電容量	≤ ±2.5%或 ±0.25PF,取兩者中最大的。	熱處理方法如下表: <table border="1" style="margin-left: 20px;"> <thead> <tr> <th>階段</th> <th>溫度(℃)</th> <th>時間(分鐘)</th> </tr> </thead> <tbody> <tr> <td>1</td> <td>最低工作溫度±3</td> <td>30±3</td> </tr> <tr> <td>2</td> <td>常溫</td> <td>2—3</td> </tr> <tr> <td>3</td> <td>最高工作溫度±2</td> <td>30±3</td> </tr> <tr> <td>4</td> <td>常溫</td> <td>2—3</td> </tr> </tbody> </table>	階段	溫度(℃)	時間(分鐘)	1	最低工作溫度±3	30±3	2	常溫	2—3	3	最高工作溫度±2	30±3	4	常溫	2—3
		階段	溫度(℃)		時間(分鐘)														
		1	最低工作溫度±3		30±3														
		2	常溫		2—3														
3	最高工作溫度±2	30±3																	
4	常溫	2—3																	
D.F.	同初始標準																		
I.R.	大于10000MΩ																		
15	濕度(穩態)	外觀	無缺陷或異常	※在 40±2℃和 90—95% 相對濕度條件下放置500+24/-0小時。 然後將其移動到室溫條件下恢復放置 24±2 小時，進行測量。															
		電容量	≤ ±5%或 ±0.5PF,取兩者中最大的。																
		D.F.	同初始標準																
		I.R.	大于10000MΩ																
16	濕度負荷	外觀	無缺陷或異常	※在 40±2℃和 90—95% 相對濕度條件下施加額定電壓 500+24/-0小時。然後將其移動到室溫條件下放置 24±2 小時， 進行測量。															
		電容量	≤ ±5%或 ±0.5PF,取兩者中最大的。																
		D.F.	同初始標準																
		I.R.	大于10000MΩ																
17	壽命	外觀	無缺陷或異常	※在上限溫度下施加2倍的額定工作電壓1000±12小時，充放電電 流不超過50mA。將其移動到室溫條件下恢復放置 24±2 小時， 進行測量。															
		電容量	≤ ±5%或 ±0.5PF,取兩者中最大的。																
		D.F.	同初始標準																
		I.R.	大于10000MΩ																



Number	Item	Standard		Test Method															
14	Temperature Cycle	Cap. Change ratio	$\leq \pm 2.5\%$ or ± 0.25 PF (whichever is larger)	※Heat-treatment: <table border="1" style="margin-left: 20px;"> <thead> <tr> <th>stage</th> <th>temperature (°C)</th> <th>time (min.)</th> </tr> </thead> <tbody> <tr> <td>1</td> <td>lowest operating temperature ± 3</td> <td>30 \pm 3</td> </tr> <tr> <td>2</td> <td>normal temperature</td> <td>2—3</td> </tr> <tr> <td>3</td> <td>high operating temperature ± 2</td> <td>30 \pm 3</td> </tr> <tr> <td>4</td> <td>normal temperature</td> <td>2—3</td> </tr> </tbody> </table>	stage	temperature (°C)	time (min.)	1	lowest operating temperature ± 3	30 \pm 3	2	normal temperature	2—3	3	high operating temperature ± 2	30 \pm 3	4	normal temperature	2—3
		stage	temperature (°C)		time (min.)														
		1	lowest operating temperature ± 3		30 \pm 3														
		2	normal temperature		2—3														
3	high operating temperature ± 2	30 \pm 3																	
4	normal temperature	2—3																	
D.F.	Same as original spec																		
I.R.	More than 10000M Ω																		
15	Humidity Steady State	Appearance	No defects or abnormalities	※Set the capacitor for 500+24/-0 hours at the condition of 40 \pm 2°C and 90-95% humidity. Then remove and set it for 24 \pm 2 hours at room temperature, then measure.															
		Cap. Change ratio	$\leq \pm 5\%$ or ± 0.5 PF (whichever is larger)																
		D.F.	Same as original spec																
		I.R.	More than 10000M Ω																
16	Humidity Load	Appearance	No defects or abnormalities	※Apply rated voltage to the capacitor for 500+24/-0 hours at the condition of 40 \pm 2°C and 90-95% humidity. Remove and set it for 24 \pm 2 hours at room temperature, then measure.															
		Cap. Change ratio	$\leq \pm 5\%$ or ± 0.5 PF (whichever is larger)																
		D.F.	Same as original spec																
		I.R.	More than 10000M Ω																
17	Life Test	Appearance	No defects or abnormalities	※Apply two times rated voltage to the capacitor for 1000 \pm 12 hours at the upper temperature limits, the charging current should be less than 50mA. Remove and set it for 24 \pm 2 hours at room temperature, then measure.															
		Cap. Change ratio	$\leq \pm 5\%$ or ± 0.5 PF (whichever is larger)																
		D.F.	Same as original spec																
		I.R.	More than 10000M Ω																

多層片式陶瓷電容器
MULTILAYER CHIP CERAMIC CAPACITOR

通用型片容特性曲綫

- COG和PH、RH、SH、TH、UH系列

温度系数圖

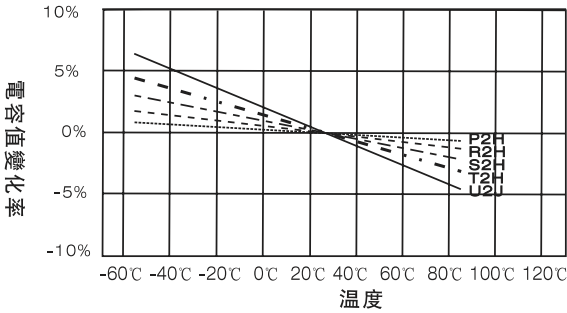

X7R温度特性

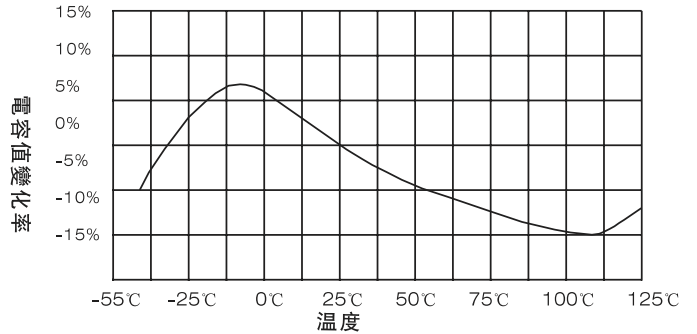

Z5U温度特性

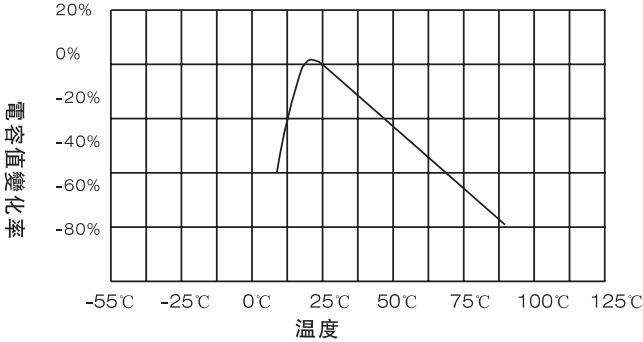

Y5V温度特性

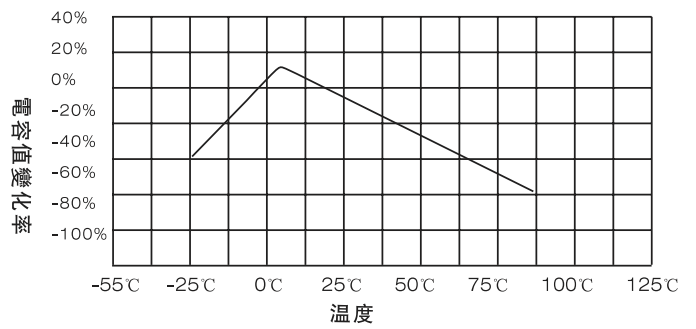

- 電容器偏壓特性圖

測量條件: COG :1MHZ
X7R,Z5U,Y5V:1KHZ

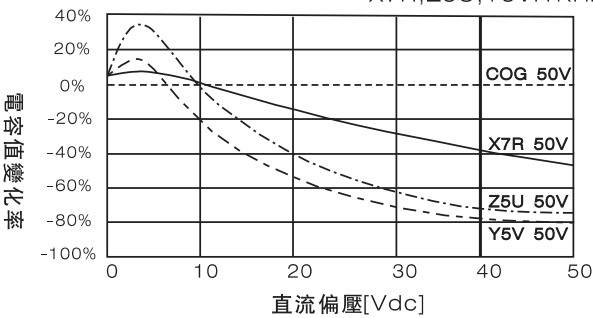

- 電容器交流電壓特性圖

測量條件: COG :1MHZ
X7R,Z5U,Y5V:1KHZ

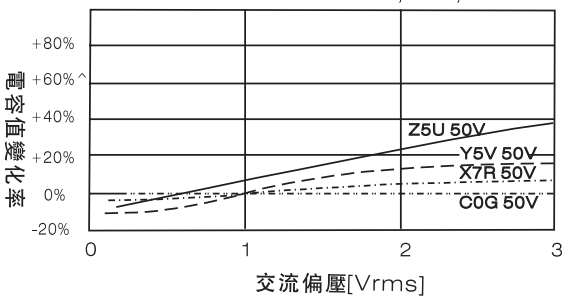

- 電容器老化特性圖

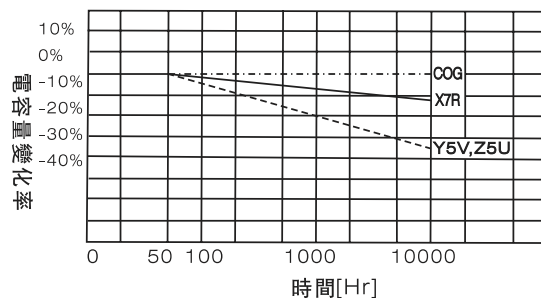



■ GENEREL-USE MLCC CHARCCTER PROFILES

- COG and PH、RH、SH、TH、UH saries temperature coefficient

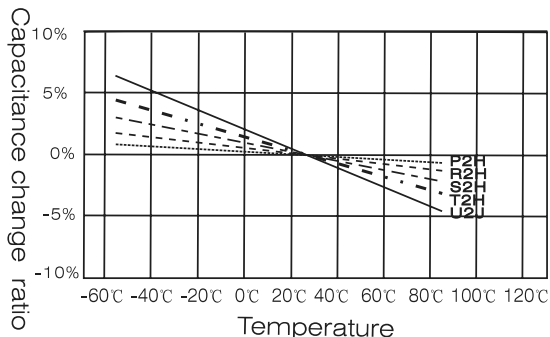

X7R temprture characteristics

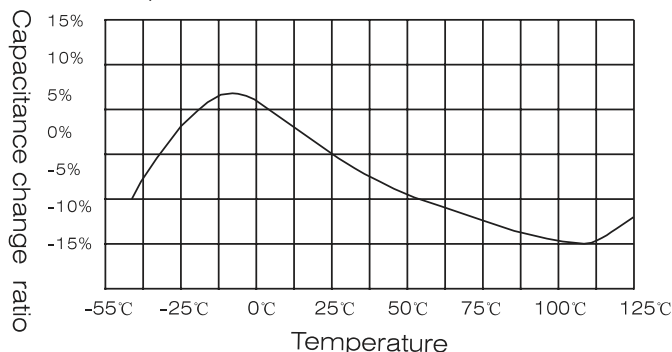

Z5U temperature character

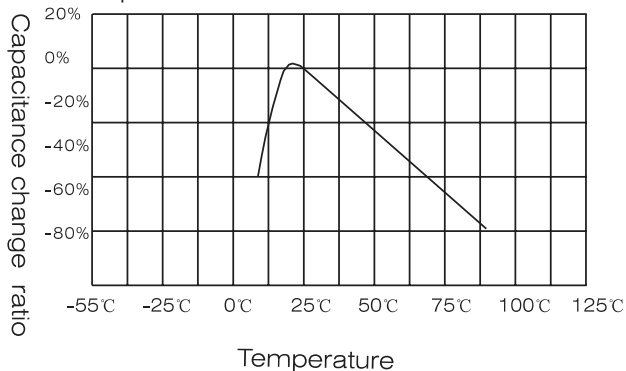

Y5V temperature characteristics

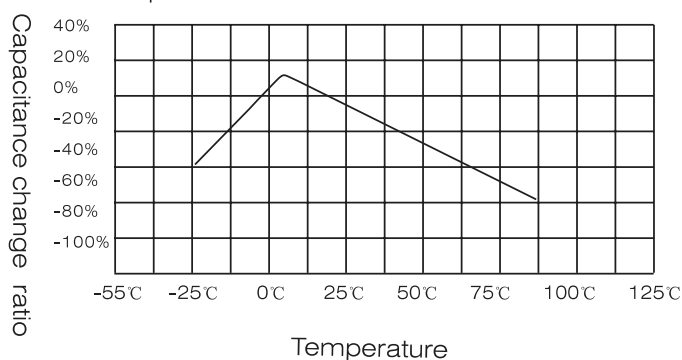

- DC Voltage Characteristics

Measuring condition COG :1MHz
X7R、Z5U、Y5V:1KHz

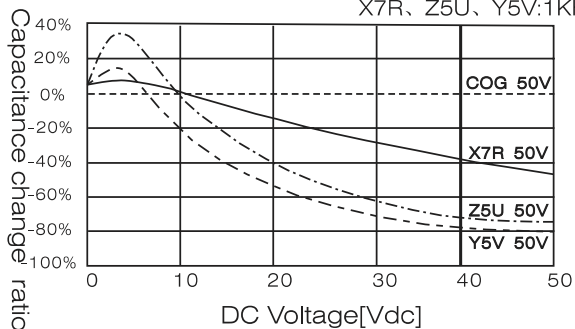

- Capacitance-AC Voltage

Characterics Measuring condition: COG :1MHz
X7R,Z5U,Y5V:1KHz

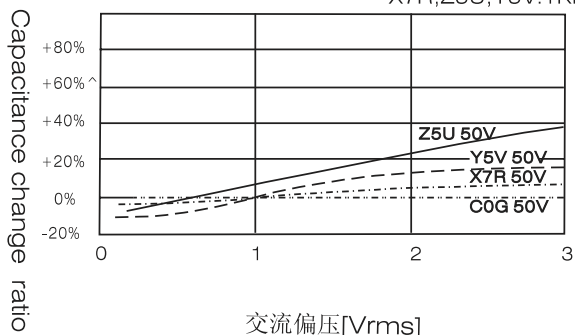

- Capacitance change aging

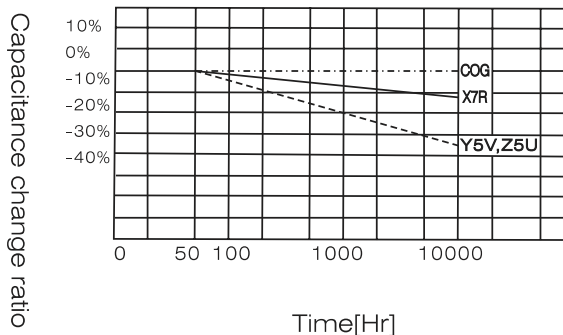

多层片式陶瓷电容器

MULTILAYER CHIP CERAMIC CAPACITOR

■ 包装

- 纸带卷盘结构

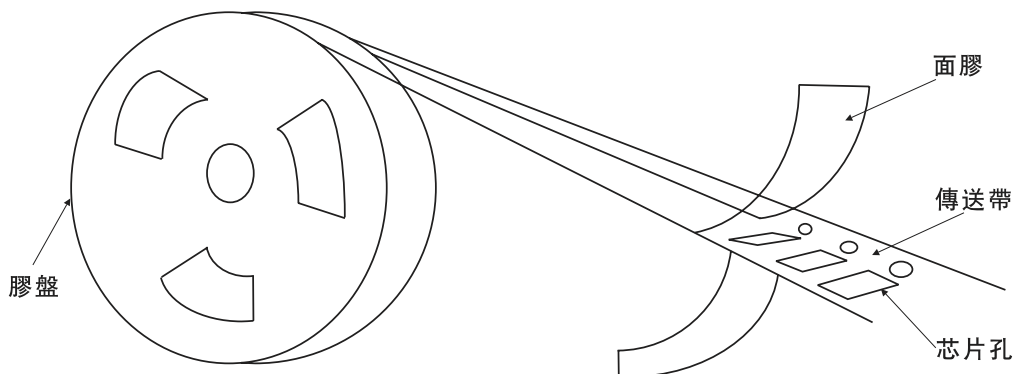

* 適合 0402,0603, 0805, 1206 常規尺寸產品的紙帶尺寸

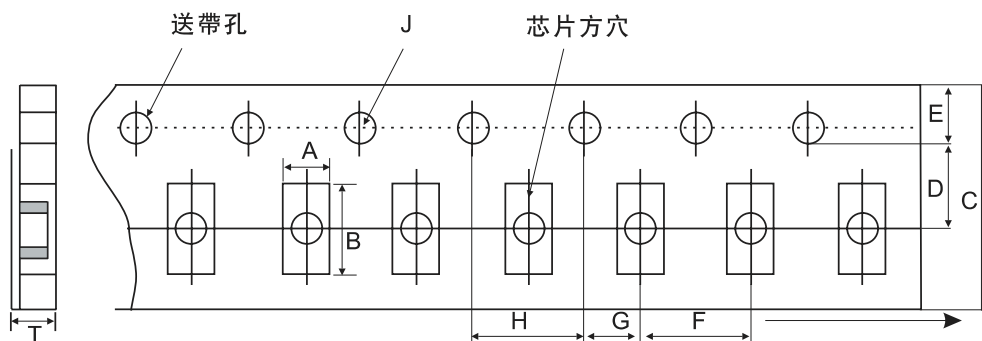

代號 紙帶規格	A	B	C	D	E	F	G	H	J	T*
0402	0.65 ±0.10	1.15 ±0.10	8.00 ±0.10	3.50 ±0.05	1.75 ±0.10	2.00 ±0.05	2.00 ±0.05	4.00 ±0.10	1.50-0/ +0.10	低于 0.80
0603	1.10 ±0.20	1.90 ±0.20	8.00 ±0.20	3.50 ±0.05	1.75 ±0.10	4.00 ±0.10	2.00 ±0.10	4.00 ±0.10	1.50-0/ +0.10	低于 1.10
0805	1.45 ±0.20	2.30 ±0.20	8.00 ±0.20	3.50 ±0.05	1.75 ±0.10	4.00 ±0.10	2.00 ±0.10	4.00 ±0.10	1.50-0/ +0.10	低于 1.10
1206	1.80 ±0.20	3.40 ±0.20	8.00 ±0.20	3.50 ±0.05	1.75 ±0.10	4.00 ±0.10	2.00 ±0.10	4.00 ±0.10	1.50-0/ +0.10	低于 1.10

■ Package

- Paper Tape Taping

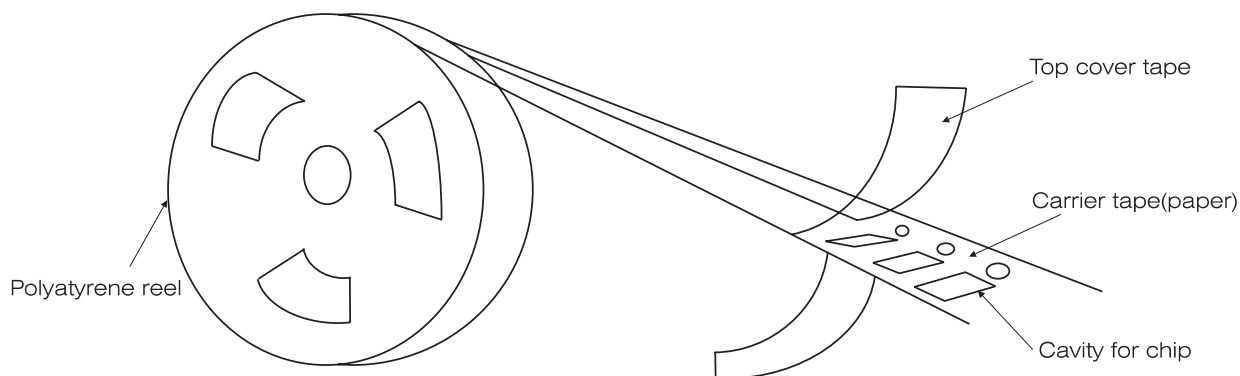

※Dimensions of paper take taping for 0402, 0603, 0805, 1206

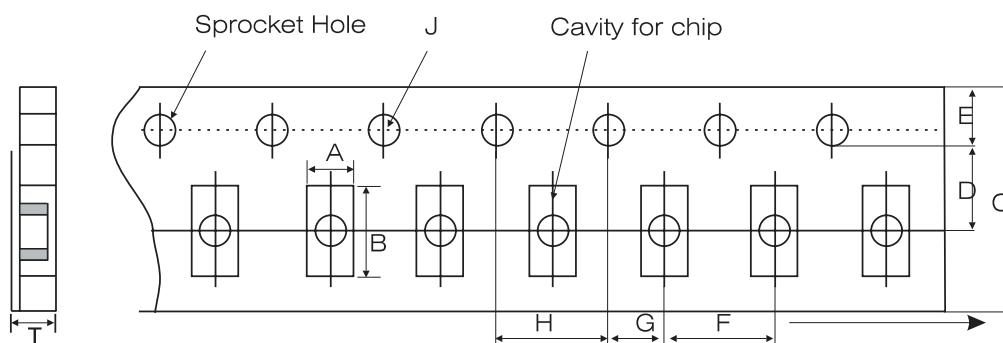

Code Paper size	A	B	C	D	E	F	G	H	J	T*
0402	0.65 ±0.10	1.15 ±0.10	8.00 ±0.10	3.50 ±0.05	1.75 ±0.10	2.00 ±0.05	2.00 ±0.05	4.00 ±0.10	1.50-0/ +0.10	Below 0.80
0603	1.10 ±0.20	1.90 ±0.20	8.00 ±0.20	3.50 ±0.05	1.75 ±0.10	4.00 ±0.10	2.00 ±0.10	4.00 ±0.10	1.50-0/ +0.10	Below 1.10
0805	1.45 ±0.20	2.30 ±0.20	8.00 ±0.20	3.50 ±0.05	1.75 ±0.10	4.00 ±0.10	2.00 ±0.10	4.00 ±0.10	1.50-0/ +0.10	Below 1.10
1206	1.80 ±0.20	3.40 ±0.20	8.00 ±0.20	3.50 ±0.05	1.75 ±0.10	4.00 ±0.10	2.00 ±0.10	4.00 ±0.10	1.50-0/ +0.10	Below 1.10

多层片式陶瓷电容器

MULTILAYER CHIP CERAMIC CAPACITOR

■ 包装

- 纸带卷盘结构

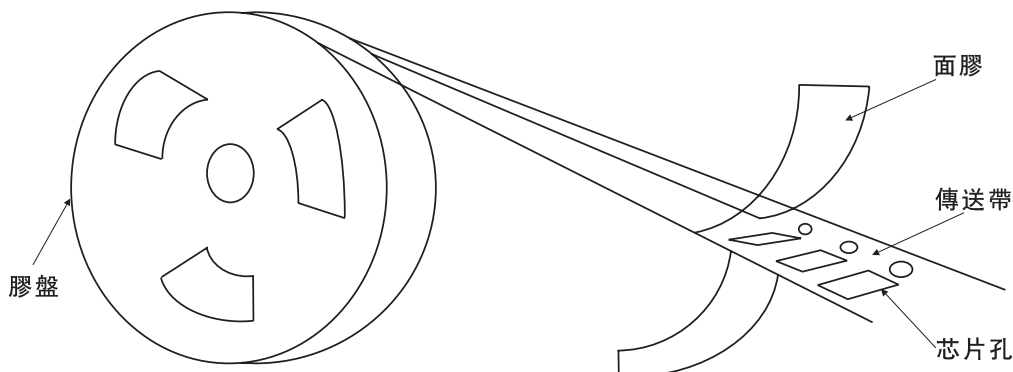

* 适合0805, 1206, 1210, 1808, 1812常规尺寸产品的塑胶带尺寸

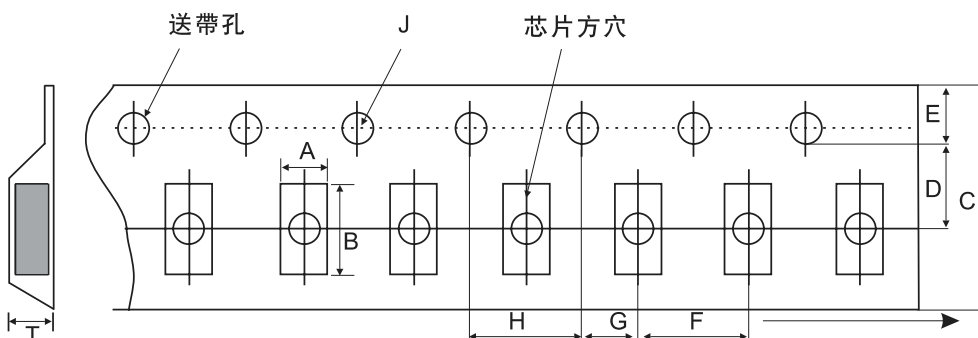

代號 紙帶規格	A	B	C	D	E	F*	G	H	J	T
0805	1.55 ±0.20	2.35 ±0.20	8.00 ±0.20	3.50 ±0.05	1.75 ±0.10	4.00 ±0.10	2.00 ±0.10	4.00 ±0.10	1.50-0/ +0.10	低于 1.50
1206	1.95 ±0.20	3.60 ±0.20	8.00 ±0.20	3.50 ±0.05	1.75 ±0.10	4.00 ±0.10	2.00 ±0.10	4.00 ±0.10	1.50-0/ +0.10	低于 1.85
1210	2.70 ±0.10	3.42 ±0.10	8.00 ±0.10	3.50 ±0.05	1.75 ±0.10	4.00 ±0.10	2.00 ±0.05	4.00 ±0.10	1.50-0/ +0.10	低于 3.2
1808	2.20 ±0.10	4.95 ±0.10	12.00 ±0.10	5.50 ±0.05	1.75 ±0.10	4.00 ±0.10	2.00 ±0.05	4.00 ±0.10	1.50-0/ +0.10	低于 3.0
1812	3.66 ±0.10	4.95 ±0.10	12.00 ±0.10	5.50 ±0.05	1.75 ±0.10	8.00 ±0.10	2.00 ±0.05	4.00 ±0.10	1.50-0/ +0.10	低于 4.0

注意:*表示此處對尺寸的要求非常精確

• Embossed Taping

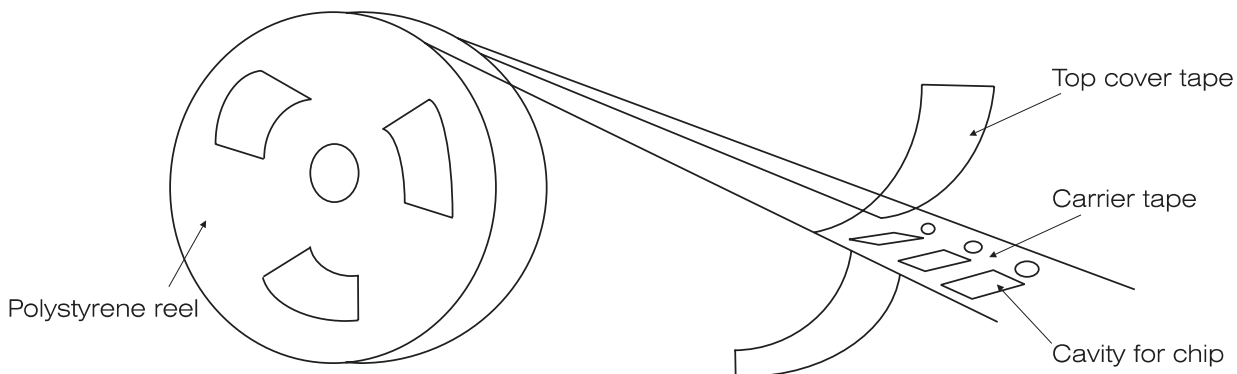

※Dimensions of embossed taping for 0805, 1206, 1210, 1808, 1812 type

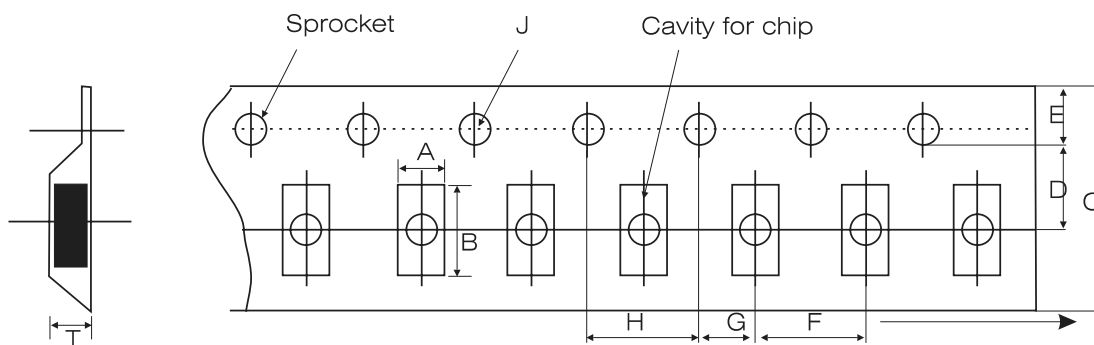

Code Tape size	A	B	C	D	E	F*	G	H	J	T
0805	1.55 ±0.20	2.35 ±0.20	8.00 ±0.20	3.50 ±0.05	1.75 ±0.10	4.00 ±0.10	2.00 ±0.10	4.00 ±0.10	1.50-0/ +0.10	低于 1.50
1206	1.95 ±0.20	3.60 ±0.20	8.00 ±0.20	3.50 ±0.05	1.75 ±0.10	4.00 ±0.10	2.00 ±0.10	4.00 ±0.10	1.50-0/ +0.10	低于 1.85
1210	2.70 ±0.10	3.42 ±0.10	8.00 ±0.10	3.50 ±0.05	1.75 ±0.10	4.00 ±0.10	2.00 ±0.05	4.00 ±0.10	1.50-0/ +0.10	低于 3.2
1808	2.20 ±0.10	4.95 ±0.10	12.00 ±0.10	5.50 ±0.05	1.75 ±0.10	4.00 ±0.10	2.00 ±0.05	4.00 ±0.10	1.50-0/ +0.10	低于 3.0
1812	3.66 ±0.10	4.95 ±0.10	12.00 ±0.10	5.50 ±0.05	1.75 ±0.10	8.00 ±0.10	2.00 ±0.05	4.00 ±0.10	1.50-0/ +0.10	低于 4.0

Note: The place with "*" means where needs exactly dimensions.

多层片式陶瓷电容器

MULTILAYER CHIP CERAMIC CAPACITOR

• 传送带的前后结构

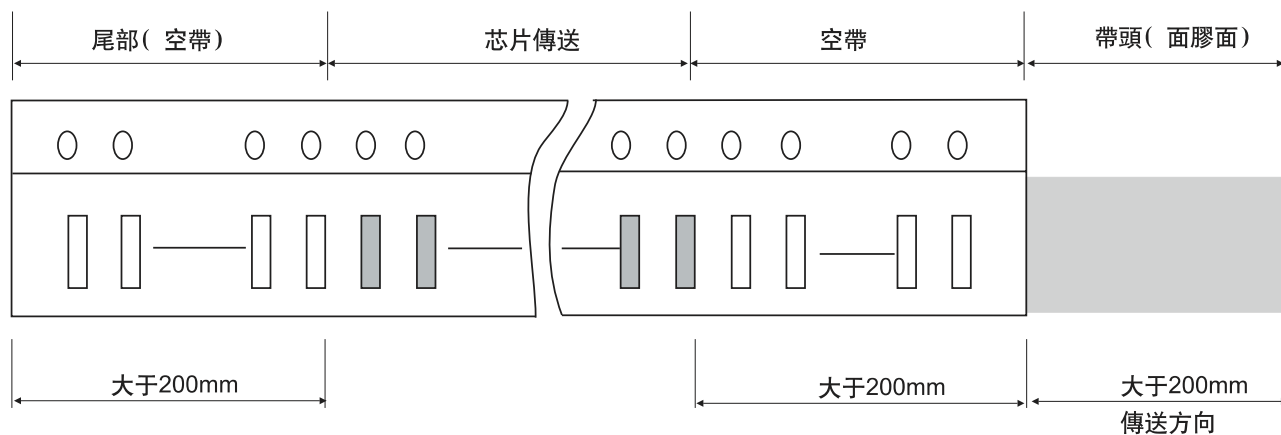

• 卷盘尺寸(单位:mm)

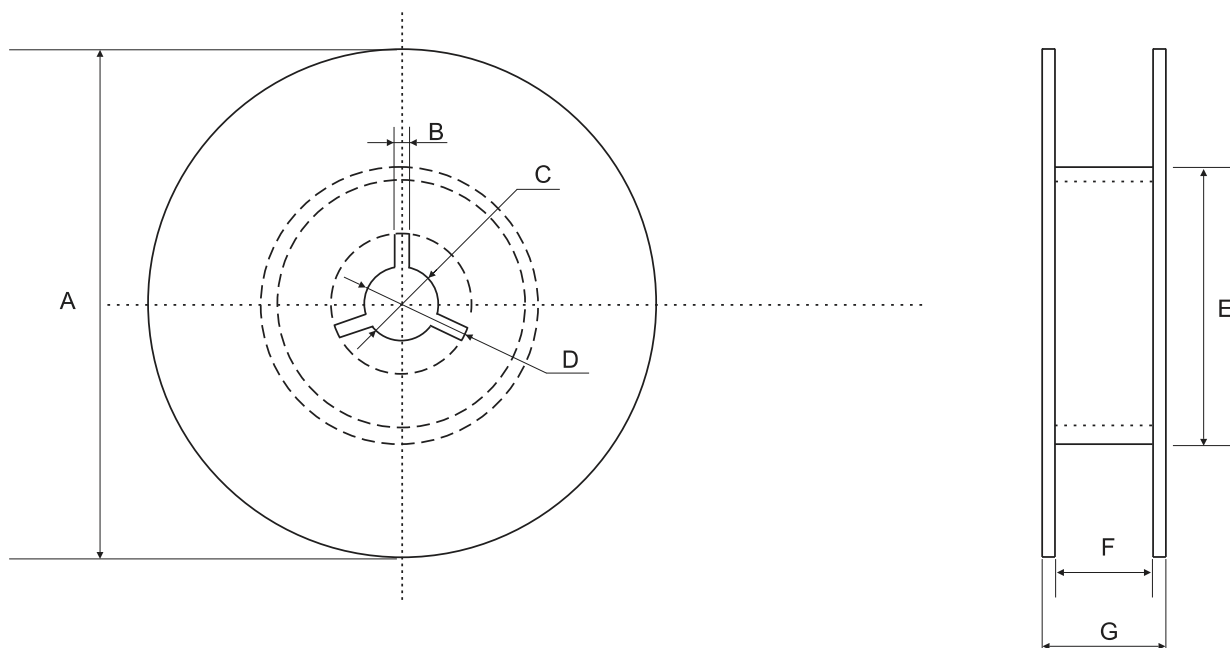

• 尺寸代码

A	B	C	D	E	F	G
$\Phi 178.00 \pm 2.00$	3.00	$\Phi 13.00 \pm 0.50$	$\Phi 21.00 \pm 0.80$	$\Phi 50.00$ 或更大	10.00 ± 1.50	12MAX
$\Phi 330.00 \pm 2.00$	3.00	$\Phi 13.00 \pm 0.50$	$\Phi 21.00 \pm 0.80$	$\Phi 50.00$ 或更大	10.00 ± 1.50	12MAX



- Structure of leader part and end part of the carrier paper

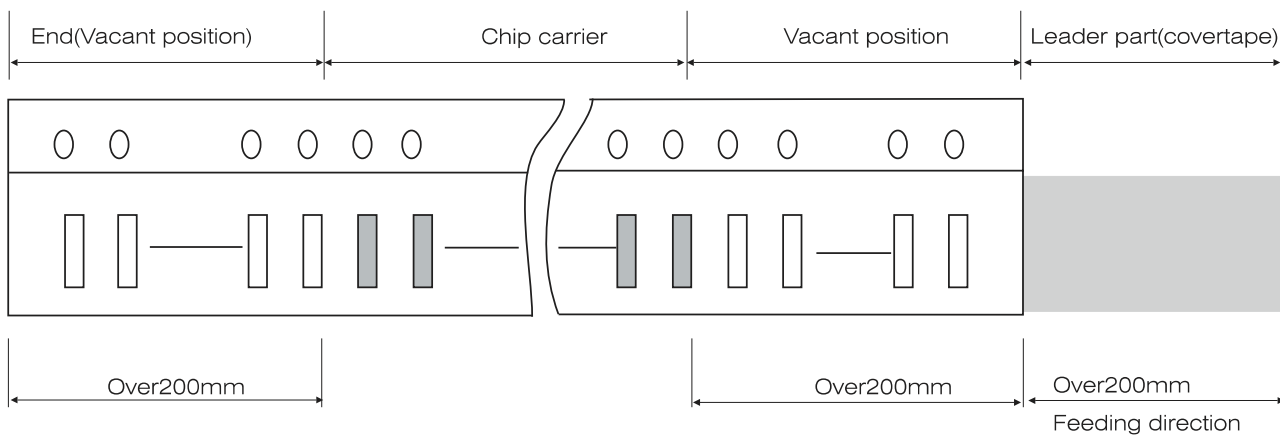

- Reel Dimensions (unit:mm)

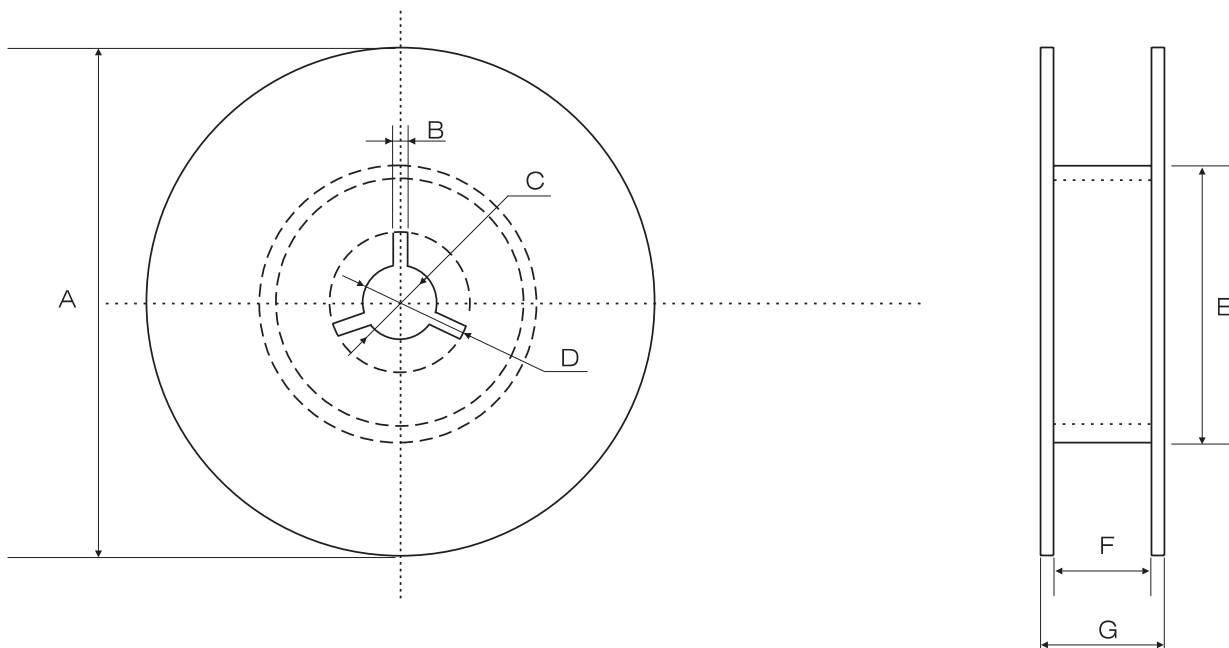

- Code

A	B	C	D	E	F	G
$\Phi 178.00 \pm 2.00$	3.00	$\Phi 13.00 \pm 0.50$	$\Phi 21.00 \pm 0.80$	$\Phi 50.00$ or max	10.00 ± 1.50	12MAX
$\Phi 330.00 \pm 2.00$	3.00	$\Phi 13.00 \pm 0.50$	$\Phi 21.00 \pm 0.80$	$\Phi 50.00$ or max	10.00 ± 1.50	12MAX

多層片式陶瓷電容器 MULTILAYER CHIP CERAMIC CAPACITOR

■ 關於卷帶的說明

- 面膠剝離強度

(A)紙帶

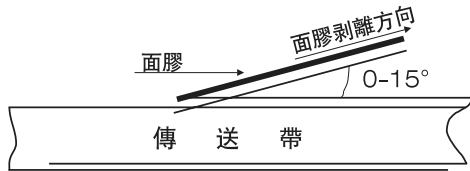

(B)塑料膠盤

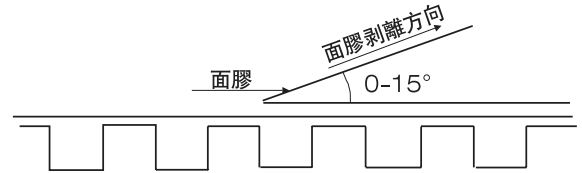

標準：0.1N<剝離強度<0.7N；在剝離時，紙帶不能有紙碎，也不能粘在底、面膠上。

- 塑料盒散包裝

標示	A	B	T	C	D	E
尺寸	6.80±0.10	8.80±1.00	12.00±0.10	15.00+0.10/-0	2.00±0/-0.10	4.70±0.10
標示	F	W	G	H	L	I
尺寸	31.50+0.20/-0	36.00+0/-0.2	19.00±0.35	7.00±0.35	110.00±0.70	5.00±0.35

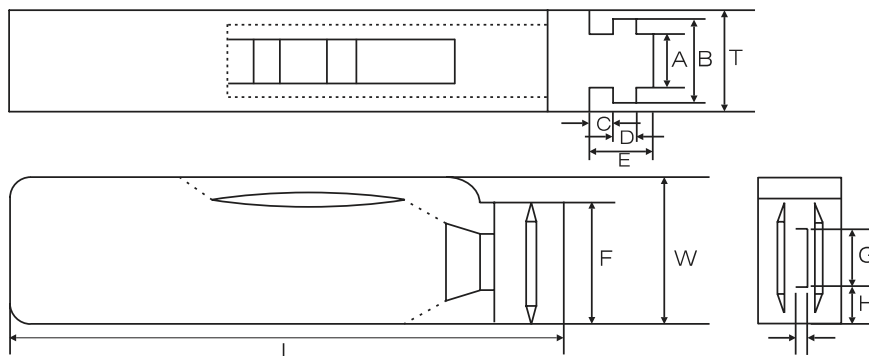

- 包裝數量

尺寸	包裝形式和數量			
	紙帶卷盤	膠帶卷盤	塑料盒散裝	一般散裝
0402	10000		20000	5000
0603	4000		15000	5000
0805	4000	3000	10000	5000
1206	4000	T≤1.35mm 3000 T>1.35mm 2000	5000	5000
1210		T≤1.80mm 2000 T>1.80mm 1000		2000
1808		2000		2000
1812		T≤1.85mm 1000 T>1.85mm 500		2000
2225		500		500
3035		500		

注意：包裝的形式和數量可根據客戶的要求來定。



■ TAPING SPECIFICATION

- Top cover tape peeling strength

(A) Paper Taping

(b) Cover tape peeling direction

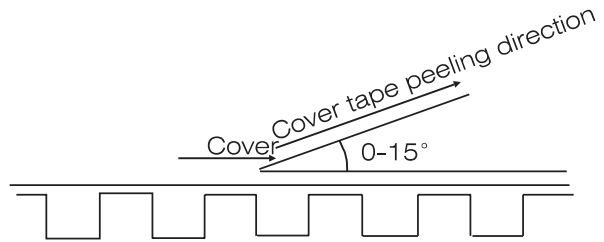
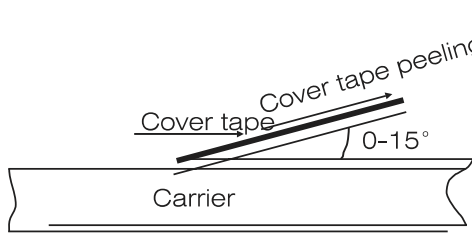

Standard: $0.1N < \text{peeling forc} < 0.7N$;
No paper dirty remains on the scotch when peeling, and no sticks to top and bottom cover tape.

- Bulk Case Package

Symbol	A	B	T	C	D	E
Dimension	6.80 ± 0.10	8.80 ± 1.00	12.00 ± 0.10	$15.00 + 0.10 / -1$	$2.00 \pm 0 / -0.10$	4.70 ± 0.10
Symol	F	W	G	H	L	I
Dimension	$31.50 + 0.20 / -0$	$36.00 + 0 / -0.2$	19.00 ± 0.35	7.00 ± 0.35	110.00 ± 0.70	5.00 ± 0.35

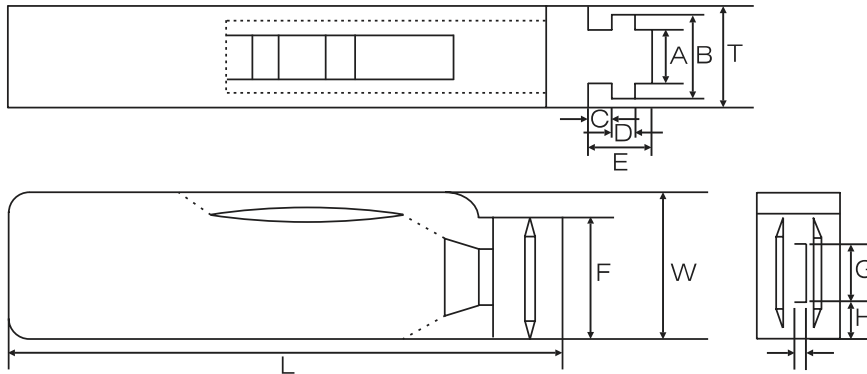

- Pack Quantity

Size	Pakaging method and quantity			
	Paper tape taping	Plastic embossed taping	Bulk plastic box packaging	Normal bulk packaging
0402	10000		20000	5000
0603	4000		15000	5000
0805	4000	3000	10000	5000
1206	4000	$T \leq 1.35\text{mm}$ 3000 $T > 1.35\text{mm}$ 2000	5000	5000
1210		$T \leq 1.80\text{mm}$ 2000 $T > 1.80\text{mm}$ 1000		2000
1808		2000		2000
1812		$T \leq 1.85\text{mm}$ 1000 $T > 1.85\text{mm}$ 500		2000
2225		500		500
3035		500		

Note: We can choose packing style and quantity can be according to the customer's requirement.