

多層片式陶瓷電容器 MULTILAYER CHIP CERAMIC CAPACITOR

■ 通用型X7R片容

通用型X7R片容屬於Ⅱ類低頻電容器，其電容量相對穩定。

● 特性

- * 具有較高的電容量且較穩定，在-55℃ ~ 125℃工作範圍內，其溫度特性為±15%。
- * 疊層獨石結構，具有高可靠性。
- * 優良的焊接性和耐焊性，適用於回流焊和波峰焊。

● 應用

- * 適用於各種濾波，耦合電路。

● 產品規格型號表示方法

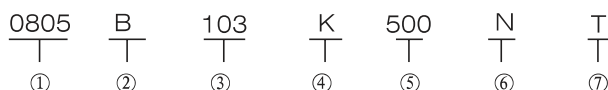

① 尺寸		
型號	英制(英寸)	公制(毫米)
0402	0.04 × 0.02	1.00 × 0.50
0603	0.06 × 0.03	1.60 × 0.80
0805	0.08 × 0.05	2.00 × 1.25
1206	0.12 × 0.06	3.20 × 1.60
1210	0.12 × 0.10	3.20 × 2.50
1812	0.18 × 0.12	4.50 × 3.20
2220	0.22 × 0.20	5.70 × 5.00

② 介質種類	
代碼	介質材料
B	X7R

③ 標稱電容量(PF)	
表示方式	實際值
101	10 × 10 ¹
102	10 × 10 ²
103	10 × 10 ³

④ 誤差級別	
代碼	誤差
J	±5%
K	±10%
M	±20%

⑦ 包裝方式	
表示方法	包裝
無標記	袋裝散包裝
T	編帶包裝
B	塑料盒散包裝

⑤ 工作電壓	
表示方法	實際電壓
6R3	6.3V
100	10V
250	25V
500	50V

⑥ 端頭類別	
表示方法	端頭材料
S	純銀端頭
C	純銅端頭
N	三層電鍍端頭 (銀或銅層/鎳層/錫層)

● 外形尺寸

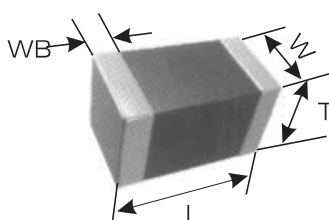

規格型號		尺寸(mm)			
英制表示	公制表示	L	W	T	WB
0402	1005	1.00 ± 0.05	0.50 ± 0.05	0.50 ± 0.05	0.25 ± 0.10
0603	1608	1.60 ± 0.10	0.80 ± 0.10	0.80 ± 0.10	0.30 ± 0.10
0805	2012	2.00 ± 0.20	1.25 ± 0.20	0.80 ± 0.10 1.00 ± 0.10 1.25 ± 0.20	0.50 ± 0.25
1206	3216	3.20 ± 0.30	1.60 ± 0.20	0.80 ± 0.10 1.00 ± 0.10 1.25 ± 0.20	0.50 ± 0.25
1210	3225	3.20 ± 0.03	2.50 ± 0.30	≤ 2.80	0.80 ± 0.30
1812	4532	4.50 ± 0.40	3.20 ± 0.30	≤ 3.50	0.80 ± 0.30
2220	5750	5.70 ± 0.40	5.00 ± 0.40	≤ 3.50	1.00 ± 0.40



■ X7R MLCC for General-use

X7R MLCC for General-use is class II low frequency capacitor, its capacitance is stable.

• Properties

- * The capacitance is stable, its operating temperature is -55℃~125℃, within the range, the temperature coefficient is ±15%.
- * It has multi-layer monolithic structure, has high reliability.
- * It has good solderability and soldering resistance, suitable for flow soldering/reflow soldering.

• Applications

It is suitable for all kinds of filter and coupling circuits.

• Product part number expression method



①Dimensions		
Type	British (Inch)	Metric (mm)
0402	0.04 × 0.02	1.00 × 0.50
0603	0.06 × 0.03	1.60 × 0.80
0805	0.08 × 0.05	2.00 × 1.25
1206	0.12 × 0.06	3.20 × 1.60
1210	0.12 × 0.10	3.20 × 2.50
1812	0.18 × 0.12	4.50 × 3.20
2220	0.22 × 0.20	5.70 × 5.00

③Normal Capacitance (PF)	
Expression Method	Actual Value
101	10 × 10 ¹
102	10 × 10 ²
103	10 × 10 ³

⑥Termination Type	
Expression Method	Termination Material
S	Pure Silver
C	Pure Copper
N	Three Layers Plating Terminal (Silver or Copper layer/ Nickel layer/ Tin layer)

④Capacitance Tolerance	
Code	Tolerance
J	±5%
K	±10%
M	±20%

②Dielectric Type	
Code	Dielectric Material
B	X7R

⑤Rated Voltage	
Expression Method	Actual Value
6R3	6.3V
100	10V
250	25V
500	50V

⑦Package Method	
Expression Method	Packaging
No Mark	Bulk Packaging in a Bag
T	Taping Packaging
B	Bulk Plastic Box Packaging

Type		Dimension (mm)			
British expression	Metric expression	L	W	T	WB
0402	1005	1.00 ± 0.05	0.50 ± 0.05	0.50 ± 0.05	0.25 ± 0.10
0603	1608	1.60 ± 0.10	0.80 ± 0.10	0.80 ± 0.10	0.30 ± 0.10
0805	2012	2.00 ± 0.20	1.25 ± 0.20	0.80 ± 0.10 1.00 ± 0.10 1.25 ± 0.20	0.50 ± 0.25
1206	3216	3.20 ± 0.30	1.60 ± 0.20	0.80 ± 0.10 1.00 ± 0.10 1.25 ± 0.20	0.50 ± 0.25
1210	3225	3.20 ± 0.03	2.50 ± 0.30	≤2.80	0.80 ± 0.30
1812	4532	4.50 ± 0.40	3.20 ± 0.30	≤3.50	0.80 ± 0.30
2220	5750	5.70 ± 0.40	5.00 ± 0.40	≤3.50	1.00 ± 0.40

• Outside Dimension

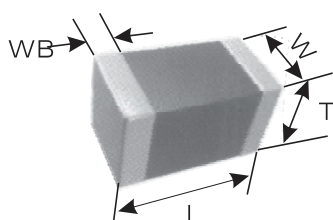

WEB www.nscn.com.cn

TEL +86-025-84712762 84712971 84712745

多層片式陶瓷電容器

MULTILAYER CHIP CERAMIC CAPACITOR

● 電容量範圍

項目	通用型X7R片容																			
	0402					0603					0805					1206				
尺寸																				
工作電壓	6.3V	10V	16V	25V	50V	6.3V	10V	16V	25V	50V	6.3V	10V	16V	25V	50V	6.3V	10V	16V	25V	50V
電容量																				
100PF																				
330PF																				
470PF																				
680PF																				
1000PF																				
1.5nF																				
2.2nF																				
3.3nF																				
4.7nF																				
6.8nF																				
10nF																				
12nF																				
15nF																				
22nF																				
27nF																				
33nF																				
39nF																				
47nF																				
56nF																				
68nF																				
100nF																				
150nF																				
220nF																				
270nF																				
330nF																				
470nF																				
820nF																				
1 μF																				
2.2 μF																				
4.7 μF																				
10 μF																				
22 μF																				
27 μF																				
33 μF																				
47 μF																				



• Capacitance Range

Item	X7R MLCC for general-use																			
DImension	0402					0603					0805					1206				
Rated Voltage	6.3V	10V	16V	25V	50V	6.3V	10V	16V	25V	50V	6.3V	10V	16V	25V	50V	6.3V	10V	16V	25V	50V
Capacitance																				
100PF																				
330PF																				
470PF																				
680PF																				
1000PF																				
1.5nF																				
2.2nF																				
3.3nF																				
4.7nF																				
6.8nF																				
10nF																				
12nF																				
15nF																				
22nF																				
27nF																				
33nF																				
39nF																				
47nF																				
56nF																				
68nF																				
100nF																				
150nF																				
220nF																				
270nF																				
330nF																				
470nF																				
820nF																				
1 μF																				
2.2 μF																				
4.7 μF																				
10 μF																				
22 μF																				
27 μF																				
33 μF																				
47 μF																				

多層片式陶瓷電容器

MULTILAYER CHIP CERAMIC CAPACITOR

● 電容量範圍

項目	通用型X7R片容														
	1210					1812					2220				
尺寸	1210					1812					2220				
工作電壓	6.3V	10V	16V	25V	50V	6.3V	10V	16V	25V	50V	6.3V	10V	16V	25V	50V
電容量															
100PF															
330PF															
470PF															
680PF															
1000PF															
1.5nF															
2.2nF															
3.3nF															
4.7nF															
6.8nF															
10nF															
12nF															
15nF															
22nF															
27nF															
33nF															
39nF															
47nF															
56nF															
68nF															
100nF															
150nF															
220nF															
270nF															
330nF															
470nF															
820nF															
1 μ F															
2.2 μ F															
4.7 μ F															
10 μ F															
22 μ F															
27 μ F															
33 μ F															
47 μ F															



• Capacitance Range

Item	X7R MLCC for general-use														
	1210					1812					2220				
Rated Voltage	6.3V	10V	16V	25V	50V	6.3V	10V	16V	25V	50V	6.3V	10V	16V	25V	50V
Capacitance															
100PF															
330PF															
470PF															
680PF															
1000PF															
1.5nF															
2.2nF															
3.3nF															
4.7nF															
6.8nF															
10nF															
12nF															
15nF															
22nF															
27nF															
33nF															
39nF															
47nF															
56nF															
68nF															
100nF															
150nF															
220nF															
270nF															
330nF															
470nF															
820nF															
1 μ F															
2.2 μ F															
4.7 μ F															
10 μ F															
22 μ F															
27 μ F															
33 μ F															
47 μ F															

多層片式陶瓷電容器

MULTILAYER CHIP CERAMIC CAPACITOR

■ 通用型X7R、X5R、Z5U、Y5V可靠性測試方法

編號	項目	標準		測試方法
1	工作溫度範圍	X5R: -55°C ~ 85°C X7R: -55°C ~ 125°C	Z5U: 10°C ~ 85°C Y5V: -25°C ~ 85°C	
2	外觀	1. 瓷體顏色一致性好。 2. 芯片無可見損傷,光滑平整。 3. 瓷體無外露電極,裂痕,孔洞。 4. 端電極無裂痕,孔洞,磨損及表面氧化等。 5. 端電極應無延伸現象或延伸部分不超過端頭寬度的一半。		※在 ≥ 10 倍以上的顯微鏡下觀察。
3	尺寸	在規定尺寸範圍內		※使用千分尺或游標卡尺。
4	電容量	在規定偏差範圍內		※測試儀器: HP4278A電橋、HP4284電橋。
5	損耗因數(D.F.)	X5R,X7R	Z5U,Y5V	※測試條件: 1. 測試溫度: $25^{\circ}\text{C} \pm 5^{\circ}\text{C}$, 濕度: 30% ~ 75%。 2. 測試電壓: $1.0 \pm 0.2\text{V}$, (Y5V) $0.5 \pm 0.2\text{V}$ (Z5U)。 3. 測試頻率: $1.0 \pm 0.1\text{KHz}$ 。
		$U_r \geq 50\text{V}$, $D_f \leq 250 \times 10^{-4}$ $U_r = 25\text{V}, 16\text{V}$: $D_f \leq 350 \times 10^{-4}$ $U_r = 10\text{V}$: $D_f \leq 500 \times 10^{-4}$ $U_r = 6.3\text{V}$: $C < 3.3\mu\text{F}$, $D_f \leq 500 \times 10^{-4}$ $C > 3.3\mu\text{F}$, $D_f \leq 1000 \times 10^{-4}$	$U_r \geq 50\text{V}$, $D_f \leq 500 \times 10^{-4}$ $U_r = 25\text{V}$: $C < 1.0\mu\text{F}$, $D_f \leq 700 \times 10^{-4}$ $C \geq 1.0\mu\text{F}$, $D_f \leq 900 \times 10^{-4}$ $U_r = 16\text{V}, 10\text{V}, 6.3\text{V}$: $D_f \leq 1250 \times 10^{-4}$	
6	絕緣電阻 (I.R.)	$C \leq 25\text{nF}$, $I_R \geq 10000\text{M}\Omega$ $C > 25\text{nF}$, $R \times C \geq 500\text{S}$	$C \leq 25\text{nF}$, $I_R \geq 4000\text{M}\Omega$ $C > 25\text{nF}$, $R \times C \geq 500\text{S}$	※測試儀器: 絕緣電阻測試儀(如: SF2511絕緣測試機)。 ※測試方法: 施加額定工作電壓, 在 60 ± 5 秒內測量絕緣電阻。
7	耐電壓強度	$> 3 \times$ 額定工作電壓		※施加3倍額定工作電壓, 持續 60 ± 1 秒, 未出現擊穿現象并且充電 / 放電電流低於 50mA 。
8	電容量溫度特性	在工作溫度範圍內符合電容器特性溫度系數要求		※首先進行預處理: 進行 $150 \pm 0 / -10^{\circ}\text{C}$ 熱處理 60 ± 5 分鐘, 然后在室溫條件下放置 24 ± 2 小時。 ※在 $-55 \sim 125^{\circ}\text{C}$ 或者 $-55 \sim 85^{\circ}\text{C}$ (X7R, X5R); $-25^{\circ}\text{C} \sim 85^{\circ}\text{C} + 10^{\circ}\text{C} \sim 85^{\circ}\text{C}$ (Y5V ~ Z5U) 範圍內測試電容量, 其電容值相對於 25°C 時數值的變化率應在規定範圍內。
9	可焊性	75% 端電極覆蓋錫		※將電容器浸在乙醇和松香溶液中。然後浸入有鉛 $235 \pm 5^{\circ}\text{C}$ (無鉛 $245 \pm 5^{\circ}\text{C}$) 的混合焊錫溶液 2 ± 0.5 秒。浸入速度: $25 \pm 2.5\text{mm/秒}$ 。



● X7R、X5R、Z5U、Y5V MLCC for general use reliability test method

Number	Item	Standard		Test Method
1	Operating Temperature Range	X5R: -55℃ ~ 85℃ X7R: -55℃ ~ 125℃	Z5U: 10℃ ~ 85℃ Y5V: -25℃ ~ 85℃	
2	Appearance	1. Good ceramic body color continuity. 2. The chips have no visual damages and must be very smooth. 3. No exposed inner- electrode, no cracks or holes. 4. The outer electrode should have no cracks, holes, damages or surface oxidation. 5. Outer electrode no prolongation or the prolongation is less than half of that of the termination width.		※Check by using microscope ≥ 10 × .
3	Dimensions	Within the specified dimensions		※Using micrometer or vernier calipers
4	Capacitance)	Within the specified tolerance		※Measuring Equipments: HP4278 capacitance meter, HP4284 capacitance,
5	Dissipation Factor (DF)	X5R,X7R	Z5U,Y5V	※Measuring Conditions: 1.Measuring Temperature: 25℃ ± 5℃ . Humidity: 30% ~ 75%. 2.Measuring Voltage: 1.0 ± 0.2V. 3.Measuring Frequency: 1.0 ± 0.1MHz
		Ur ≥ 50V, DF ≤ 250 × 10 ⁻⁴ Ur=25V,16V: DF ≤ 350 × 10 ⁻⁴ Ur=10V: DF ≤ 500 × 10 ⁻⁴ Ur=6.3V: C < 3.3uF, DF ≤ 500 × 10 ⁻⁴ C ≥ 3.3uF, DF ≤ 1000 × 10 ⁻⁴	Ur=50V,DF ≤ 500 × 10 ⁻⁴ Ur=25V: C < 1.0 μ F,DF ≤ 700 × 10 ⁻⁴ C ≥ 1.0 μ F,DF ≤ 900 × 10 ⁻⁴ Ur=16V, 10V, 6.3V: DF ≤ 1250 × 10 ⁻⁴	
6	Insulation Resistance	C ≤ 25nF,IR ≥ 10000M.Ω C > 25nF,R × C ≥ 500S	C ≤ 25nF,IR ≥ 40000M.Ω C > 25nF,R × C ≥ 500S	※Measuring Equipment: Insulation resistance meter (such as Sf2511 insulation resistance). ※Measuring Method: Must measure at rated voltage, and measure the IR within 60 ± 5 seconds.
7	Withstanding Voltage	> 3Ur		※Must measure at 3 times rated voltage, dwell time: 60 ± 1 seconds, no short and the changing/discharging current less than 50mA.
8	Capacitance Temperature Characteristic	Must meet the capacitor character temperature coefficient requirements within the operating temperature range.		※First, pre-heat: heat treat 60 ± 5 minutes at 150+0/-10℃, then set it for 24 ± 2 hours at room temperature. ※Measure the capacitance at -55 ~ 125℃ or -55 ~ 85℃, the capacitance change ratio comparing to that of 25℃ must be within the specified range.
9	Solderability	Tin coverage should be 75% of the outer electrode		※Dip the capacitor into ethanol or colophony solution,and then dip it into 245 ± 5℃ eutectic solder solution for 2 ± 0.5 seconds. Dipping speed: 25 ± 2.5mm/second.

多層片式陶瓷電容器 MULTILAYER CHIP CERAMIC CAPACITOR

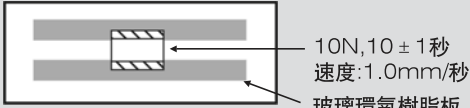
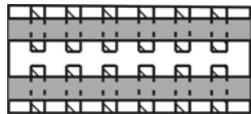
編號	項目	標準		測試方法
10	耐焊接熱	外觀	無明顯缺陷	※首先進行預處理：進行 $150 \pm 0 / -10^{\circ}\text{C}$ 熱處理 60 ± 5 分鐘，然后在室溫條件下放置 24 ± 2 小時。 ※然後按下表預熱電容器。將電容器浸入 $265 \pm 5^{\circ}\text{C}$ 的混合焊錫溶液 10 ± 1 秒。再在室溫條件下放置 24 ± 2 小時，然後進行測量。 浸入速度： $25 \pm 2.5\text{mm/秒}$ 。 ※預熱條件如下：
		電容量變化率	X7R, X5R:在20%範圍內 Z5U, Y5V:在30%範圍內	
		D.F.	同初始標準	
		I.R.	同初始標準	
11	端電極結合強度	不應出現端電極脫落或其它缺陷。		※使用混合焊錫將電容器焊接在圖 1 中所示的測試夾具（玻璃環氧樹脂板）上。然後沿箭頭方向施加 10N 的力。焊接應利用烙鐵或使用回流焊方法進行，而且應謹慎作業，以使焊接均勻且不會出現熱衝擊等不良現象。
				
圖1				
12	耐振動性	外觀	無缺陷或異常	※將電容器焊接在測試夾具（玻璃環氧樹脂板）上。電容器應進行簡諧運動，其總幅值為 1.5mm，頻率在近似 10—55Hz 之間均勻變化。頻率範圍（從 10 至 55Hz 再返回 10Hz）應在約 1 分鐘內完成。振動應在三個相互垂直方向各進行 2 小時（總計 6 小時）。
		電容量	在規定偏差範圍內	
		D.F.	同初始標準	
				
圖2				
13	抗彎曲性能	不應出現裂痕或其他缺陷		※使用混合焊錫將電容器焊接在圖 3 中所示的測試夾具（玻璃環氧樹脂板）上，然後在圖 4 所示的方向加力。焊接應利用烙鐵或使用回流焊方法進行，而且應謹慎作業，以使焊接均勻且不會出現熱衝擊等不良現象。

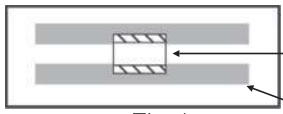
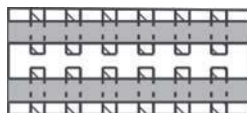
Number	Item	Standard		Test Method									
10	Resistance to Soldering	Appearance	No defects visible	※First pre-heat: heat treat for 60 ± 5 minutes at $150 \pm 0/-10^\circ\text{C}$, then set it for 24 ± 2 hours at room temperature. ※Then pre-heat the capacitance according to the following chart. Dip the capacitor into $265 \pm 5^\circ\text{C}$ eutectic solder solution for $10 \pm 1\text{s}$. Then set it for 24 ± 2 hours at room temperature, then measure. Dipping speed: $25 \pm 2.5\text{mm/second}$. ※Preheat conditions: <table border="1" style="margin-left: 20px;"> <thead> <tr> <th>Stage</th> <th>Temperature</th> <th>Time</th> </tr> </thead> <tbody> <tr> <td>1</td> <td>$100^\circ\text{C} - 120^\circ\text{C}$</td> <td>1 minute</td> </tr> <tr> <td>2</td> <td>$170^\circ\text{C} - 200^\circ\text{C}$</td> <td>1 minute</td> </tr> </tbody> </table>	Stage	Temperature	Time	1	$100^\circ\text{C} - 120^\circ\text{C}$	1 minute	2	$170^\circ\text{C} - 200^\circ\text{C}$	1 minute
		Stage	Temperature		Time								
		1	$100^\circ\text{C} - 120^\circ\text{C}$		1 minute								
		2	$170^\circ\text{C} - 200^\circ\text{C}$		1 minute								
Cap. Change ratio	X7R, X5R: within 20% Z5U, Y5V: within 30%												
DF	Same as original spec.												
		IR	Same as original spec.										
11	Adhesive Strength of Termination	No removal of the terminations or other defect shall occur		※Solder the capacitor to the test jig (glass epoxy resin board) shown in Fig.1 using a eutectic solder. Then apply a 10N force in the direction shown as the arrowhead. The soldering shall be done either with an iron or using the reflow method and shall be conducted with care so that the soldering is uniform and free of defects such as heat shock, etc. <div style="text-align: center;">  <p>10N, $10 \pm 1\text{s}$ Speed: 1.0mm/s Glass epoxy resinboard</p> <p>Fig.1</p> </div>									
12	Resistance to Vibration	Appearance	No defects or abnormalities	※Solder the capacitor to the test jig (glass epoxy resin board). The capacitor should be subjected to a simple harmonic motion having a total amplitude of 1.5mm, the frequency being varied uniformly between the approximate limits of 10 and 55Hz, shall be traversed (from 10 Hz to 55 Hz then 10 Hz again) in approximately 1 minute. This motion shall be applied for a period of 2 hours in each 3 mutually perpendicular directions (total is 6 hours). <div style="text-align: center;">  <p>Fig.2</p> </div>									
		Capacitance	Within the specified tolerance range										
		D.F.	Same as original spec.										
13	Bending Resistance	No cracks or other defects shall occur		※Solder the capacitor to the test jig (glass epoxy resin board) shown in Fig.3 using a eutectic solder. Then apply a 10N force in the direction shown as Fig.4. The soldering shall be done either with an iron or using the reflow method and shall be conducted with care so that the soldering is uniform and free of defects such as heat shock, etc.									

多層片式陶瓷電容器 MULTILAYER CHIP CERAMIC CAPACITOR

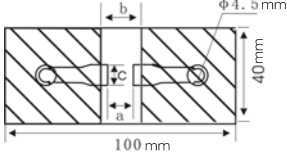
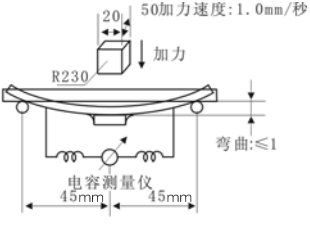
編號	項目	標準	測試方法																							
13	抗彎曲性能		  <table border="1" data-bbox="906 660 1252 801"> <thead> <tr> <th rowspan="2">L×W (mm)</th> <th colspan="4">尺寸 (mm)</th> </tr> <tr> <th>a</th> <th>b</th> <th>c</th> <th>d</th> </tr> </thead> <tbody> <tr> <td>4.5×2.0</td> <td>3.5</td> <td>7.0</td> <td>2.4</td> <td rowspan="3">1.0</td> </tr> <tr> <td>4.5×3.2</td> <td>3.5</td> <td>7.0</td> <td>3.7</td> </tr> <tr> <td>5.7×6.3</td> <td>4.5</td> <td>8.0</td> <td>5.6</td> </tr> </tbody> </table>	L×W (mm)	尺寸 (mm)				a	b	c	d	4.5×2.0	3.5	7.0	2.4	1.0	4.5×3.2	3.5	7.0	3.7	5.7×6.3	4.5	8.0	5.6	
L×W (mm)	尺寸 (mm)																									
	a	b	c	d																						
4.5×2.0	3.5	7.0	2.4	1.0																						
4.5×3.2	3.5	7.0	3.7																							
5.7×6.3	4.5	8.0	5.6																							
14	溫度循環	<table border="1"> <tr> <td>外觀</td> <td>無缺陷或異常</td> </tr> <tr> <td>電容量變化率</td> <td>X7R, X5R: 在 ±20%範圍內 Z5U, Y5V: 在 ±30%範圍內</td> </tr> <tr> <td>D.F.</td> <td>同初始標準</td> </tr> <tr> <td>I.R.</td> <td>同初始標準</td> </tr> </table>	外觀	無缺陷或異常	電容量變化率	X7R, X5R: 在 ±20%範圍內 Z5U, Y5V: 在 ±30%範圍內	D.F.	同初始標準	I.R.	同初始標準	<table border="1"> <thead> <tr> <th>階段</th> <th>溫度 (°C)</th> <th>時間 (分鐘)</th> </tr> </thead> <tbody> <tr> <td>1</td> <td>最低工作溫度 ±3</td> <td>30 ± 3</td> </tr> <tr> <td>2</td> <td>常溫</td> <td>2—3</td> </tr> <tr> <td>3</td> <td>最高工作溫度 ±2</td> <td>30 ± 3</td> </tr> <tr> <td>4</td> <td>常溫</td> <td>2—3</td> </tr> </tbody> </table>	階段	溫度 (°C)	時間 (分鐘)	1	最低工作溫度 ±3	30 ± 3	2	常溫	2—3	3	最高工作溫度 ±2	30 ± 3	4	常溫	2—3
外觀	無缺陷或異常																									
電容量變化率	X7R, X5R: 在 ±20%範圍內 Z5U, Y5V: 在 ±30%範圍內																									
D.F.	同初始標準																									
I.R.	同初始標準																									
階段	溫度 (°C)	時間 (分鐘)																								
1	最低工作溫度 ±3	30 ± 3																								
2	常溫	2—3																								
3	最高工作溫度 ±2	30 ± 3																								
4	常溫	2—3																								
15	濕度(穩態)	<table border="1"> <tr> <td>外觀</td> <td>無缺陷或異常</td> </tr> <tr> <td>電容量變化率</td> <td>X7R, X5R: 在 ±20%範圍內 Z5U, Y5V: 在 ±30%範圍內</td> </tr> <tr> <td>D.F.</td> <td>同初始標準</td> </tr> <tr> <td>I.R.</td> <td>同初始標準</td> </tr> </table>	外觀	無缺陷或異常	電容量變化率	X7R, X5R: 在 ±20%範圍內 Z5U, Y5V: 在 ±30%範圍內	D.F.	同初始標準	I.R.	同初始標準	<p>※在 40 ± 2°C 和 90—95% 相對濕度條件下放置 500+24/-0 小時。然後將其移動到室溫條件下恢復放置 48 ± 2 小時，進行測量。</p>															
外觀	無缺陷或異常																									
電容量變化率	X7R, X5R: 在 ±20%範圍內 Z5U, Y5V: 在 ±30%範圍內																									
D.F.	同初始標準																									
I.R.	同初始標準																									
16	濕度負荷	<table border="1"> <tr> <td>外觀</td> <td>無缺陷或異常</td> </tr> <tr> <td>電容量變化率</td> <td>X7R, X5R: 在 ±20%範圍內 Z5U, Y5V: 在 ±30%範圍內</td> </tr> <tr> <td>D.F.</td> <td>同初始標準</td> </tr> <tr> <td>I.R.</td> <td>同初始標準</td> </tr> </table>	外觀	無缺陷或異常	電容量變化率	X7R, X5R: 在 ±20%範圍內 Z5U, Y5V: 在 ±30%範圍內	D.F.	同初始標準	I.R.	同初始標準	<p>※在 40 ± 2°C 和 90—95% 相對濕度條件下施加額定電壓 500+24/-0 小時。然後將其移動到室溫條件下放置 48 ± 2 小時，進行測量。</p>															
外觀	無缺陷或異常																									
電容量變化率	X7R, X5R: 在 ±20%範圍內 Z5U, Y5V: 在 ±30%範圍內																									
D.F.	同初始標準																									
I.R.	同初始標準																									
17	壽命	<table border="1"> <tr> <td>外觀</td> <td>無缺陷或異常</td> </tr> <tr> <td>電容量變化率</td> <td>X7R, X5R: 在 ±20%範圍內 Z5U, Y5V: 在 ±30%範圍內</td> </tr> <tr> <td>D.F.</td> <td>同初始標準</td> </tr> <tr> <td>I.R.</td> <td>同初始標準</td> </tr> </table>	外觀	無缺陷或異常	電容量變化率	X7R, X5R: 在 ±20%範圍內 Z5U, Y5V: 在 ±30%範圍內	D.F.	同初始標準	I.R.	同初始標準	<p>※在上限溫度下施加2倍的額定工作電壓1000 ± 12小時，充放電電流不超過50mA。將其移動到室溫條件下恢復放置 48 ± 2 小時，進行測量。</p>															
外觀	無缺陷或異常																									
電容量變化率	X7R, X5R: 在 ±20%範圍內 Z5U, Y5V: 在 ±30%範圍內																									
D.F.	同初始標準																									
I.R.	同初始標準																									

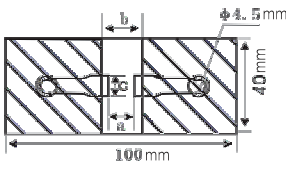
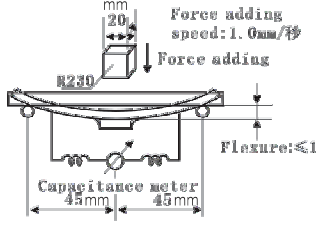
Number	Item	Standard		Test Method																								
13	Bending Resistance			  <table border="1" data-bbox="853 649 1204 795"> <thead> <tr> <th rowspan="2">L×W (mm)</th> <th colspan="4">Dimension</th> </tr> <tr> <th>a</th> <th>b</th> <th>c</th> <th>d</th> </tr> </thead> <tbody> <tr> <td>4.5×2.0</td> <td>3.5</td> <td>7.0</td> <td>2.4</td> <td></td> </tr> <tr> <td>4.5×3.2</td> <td>3.5</td> <td>7.0</td> <td>3.7</td> <td>1.0</td> </tr> <tr> <td>5.7×6.3</td> <td>4.5</td> <td>8.0</td> <td>5.6</td> <td></td> </tr> </tbody> </table>	L×W (mm)	Dimension				a	b	c	d	4.5×2.0	3.5	7.0	2.4		4.5×3.2	3.5	7.0	3.7	1.0	5.7×6.3	4.5	8.0	5.6	
L×W (mm)	Dimension																											
	a	b	c	d																								
4.5×2.0	3.5	7.0	2.4																									
4.5×3.2	3.5	7.0	3.7	1.0																								
5.7×6.3	4.5	8.0	5.6																									
14	Temperature Cycle	Appearance	No defects	<table border="1" data-bbox="774 851 1428 1019"> <thead> <tr> <th>Stage</th> <th>Temperature (°C)</th> <th>Time (min.)</th> </tr> </thead> <tbody> <tr> <td>1</td> <td>Min. Operating Temperature ±3</td> <td>30 ±3</td> </tr> <tr> <td>2</td> <td>Room Temperature</td> <td>2—3</td> </tr> <tr> <td>3</td> <td>Max. Operating Temperature 2</td> <td>30 ±3</td> </tr> <tr> <td>4</td> <td>Room Temperature</td> <td>2—3</td> </tr> </tbody> </table>	Stage	Temperature (°C)	Time (min.)	1	Min. Operating Temperature ±3	30 ±3	2	Room Temperature	2—3	3	Max. Operating Temperature 2	30 ±3	4	Room Temperature	2—3									
Stage	Temperature (°C)	Time (min.)																										
1	Min. Operating Temperature ±3	30 ±3																										
2	Room Temperature	2—3																										
3	Max. Operating Temperature 2	30 ±3																										
4	Room Temperature	2—3																										
	Cap. Change ratio	X7R, X5R: within ±20% Z5U, Y5V: within ±30%																										
	D.F.	Same as original standard																										
	I.R.	same as original standard																										
15	Humidity Steady State	Appearance	No defects	※Set the capacitor for 500+24/-0 hours at the condition of 40±2°C and 90-95% humidity. Then remove and set it for 48±2 hours at room temperature, then measure.																								
	Cap. Change ratio	X7R, X5R: within ±20% Z5U, Y5V: within ±30%																										
	D.F.	Same as original standard																										
	I.R.	Same as original standard																										
16	Humidity Load	Appearance	No defects	※Apply rated voltage to the capacitor for 500+24/-0 hours at the condition of 40±2°C and 90-95% humidity. Remove and set it for 48±2 hours at room temperature, then measure.																								
	Cap. Change ratio	X7R, X5R: within ±20% Z5U, Y5V: within ±30%																										
	D.F.	Same as original standard																										
	I.R.	Same as original standard																										
17	Life Test	Appearance	No defects	※Apply two times rated voltage to the capacitor for 1000±12 hours at the upper temperature limits, the charging current should be less than 50mA. Remove and set it for 24 2 hours at room temperature, then measure.																								
	Cap. Change ratio	X7R, X5R: within ±20% Z5U, Y5V: within ±30%																										
	D.F.	Same as original standard																										
	I.R.	Same as original standard																										

多層片式陶瓷電容器
MULTILAYER CHIP CERAMIC CAPACITOR

通用型片容特性曲綫

- COG和PH、RH、SH、TH、UH系列

温度系数圖

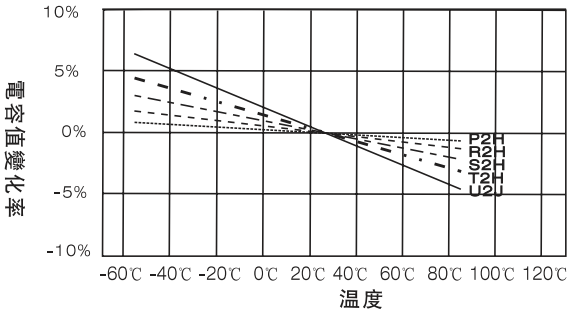

X7R温度特性

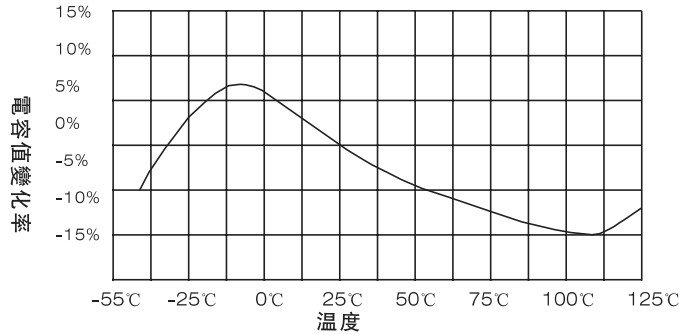

Z5U温度特性

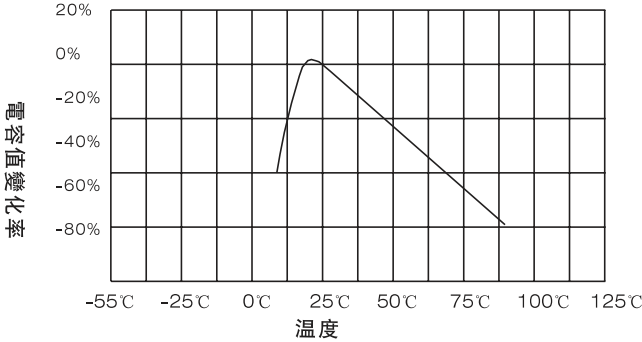

Y5V温度特性

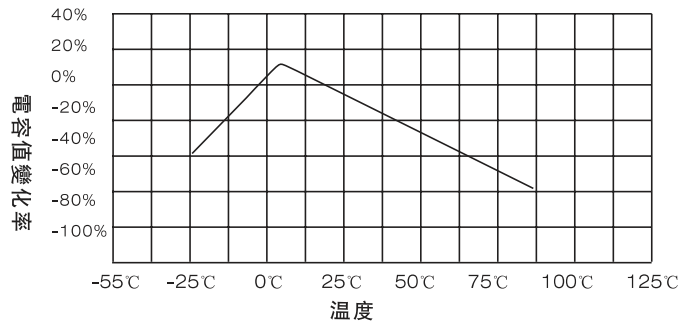

電容器偏壓特性圖

測量條件: COG :1MHZ
X7R,Z5U,Y5V:1KHZ

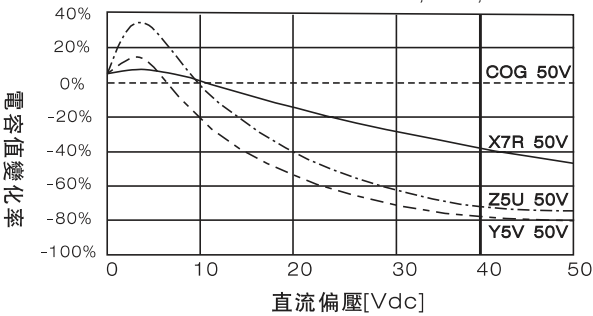

電容器交流電壓特性圖

測量條件: COG :1MHZ
X7R,Z5U,Y5V:1KHZ

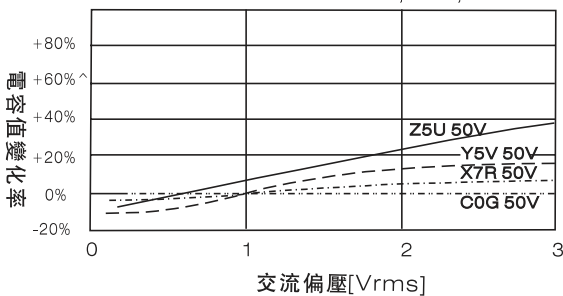

電容器老化特性圖

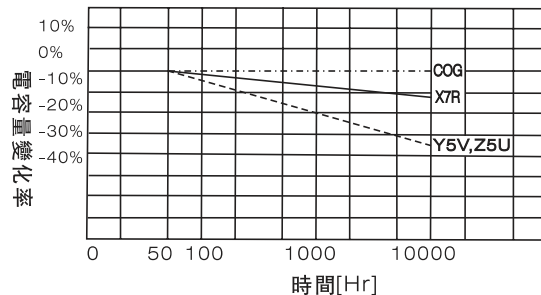



■ GENEREL-USE MLCC CHARCCTER PROFILES

- COG and PH、RH、SH、TH、UH saries temperature coefficient

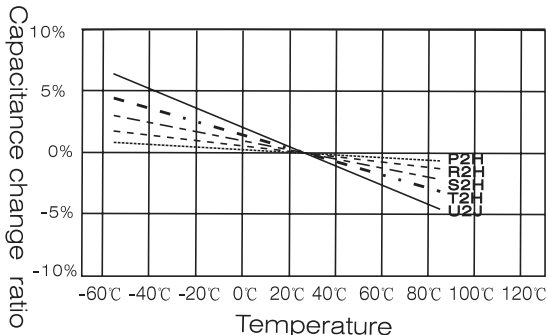

X7R temprture characteristics

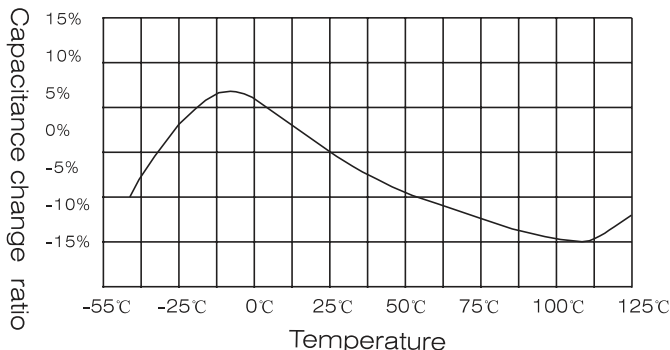

Z5U temperature character

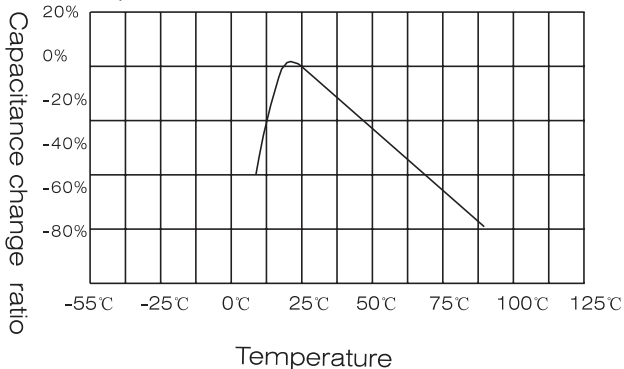

Y5V temperature characteristics

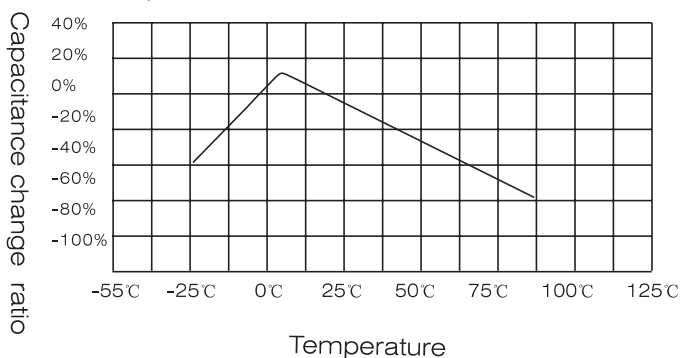

- DC Voltage Characteristics

Measuring condition COG :1MHz
X7R、Z5U、Y5V:1KHz

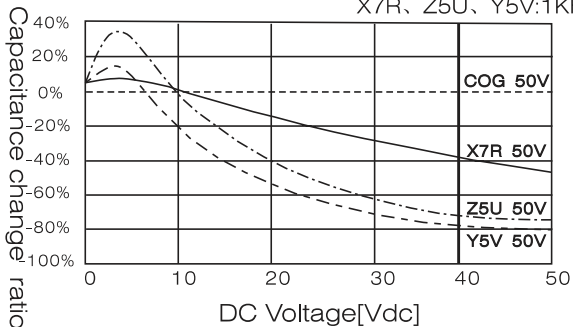

- Capacitance-AC Voltage

Characterics Measuring condition: COG :1MHz
X7R,Z5U,Y5V:1KHz

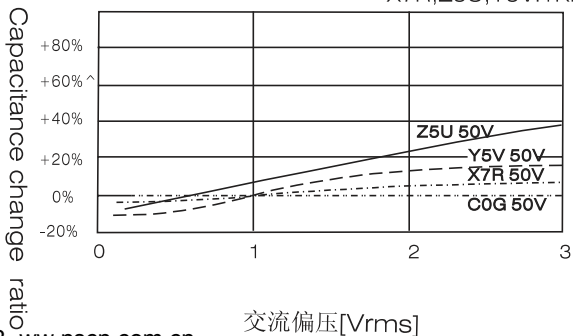

- Capacitance change aging

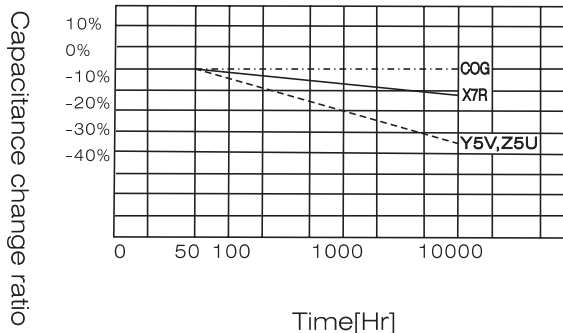

多层片式陶瓷电容器

MULTILAYER CHIP CERAMIC CAPACITOR

■ 包装

- 纸带卷盘结构

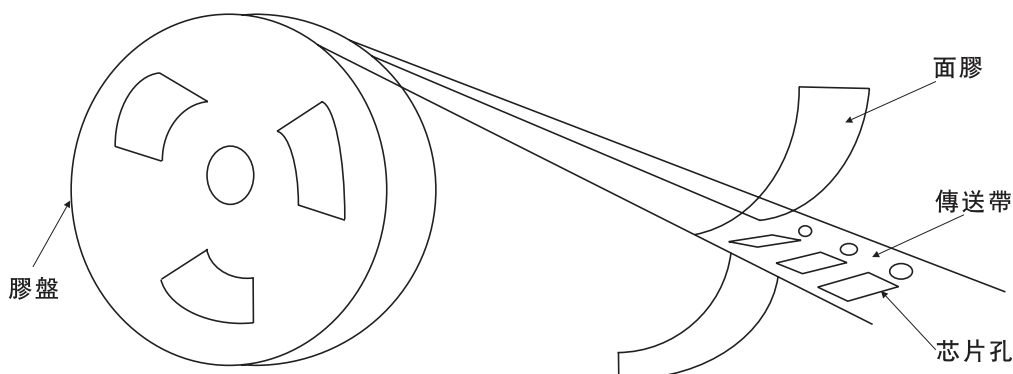

* 適合 0402,0603, 0805, 1206 常規尺寸產品的紙帶尺寸

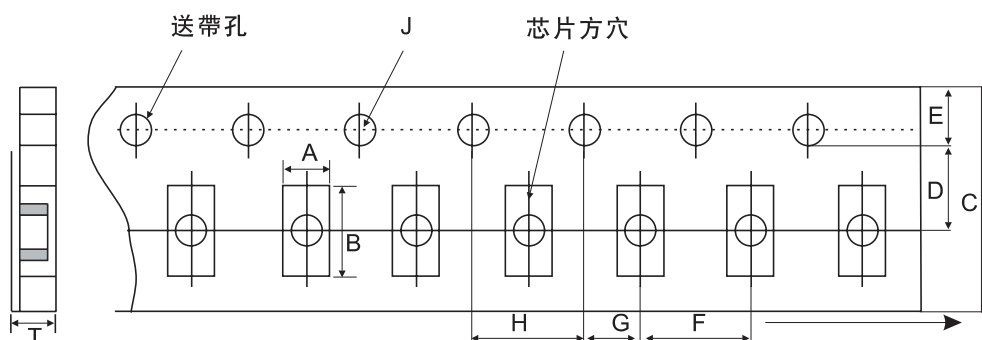

代號 紙帶規格	A	B	C	D	E	F	G	H	J	T*
0402	0.65 ±0.10	1.15 ±0.10	8.00 ±0.10	3.50 ±0.05	1.75 ±0.10	2.00 ±0.05	2.00 ±0.05	4.00 ±0.10	1.50-0/ +0.10	低于 0.80
0603	1.10 ±0.20	1.90 ±0.20	8.00 ±0.20	3.50 ±0.05	1.75 ±0.10	4.00 ±0.10	2.00 ±0.10	4.00 ±0.10	1.50-0/ +0.10	低于 1.10
0805	1.45 ±0.20	2.30 ±0.20	8.00 ±0.20	3.50 ±0.05	1.75 ±0.10	4.00 ±0.10	2.00 ±0.10	4.00 ±0.10	1.50-0/ +0.10	低于 1.10
1206	1.80 ±0.20	3.40 ±0.20	8.00 ±0.20	3.50 ±0.05	1.75 ±0.10	4.00 ±0.10	2.00 ±0.10	4.00 ±0.10	1.50-0/ +0.10	低于 1.10

■ Package

- Paper Tape Taping

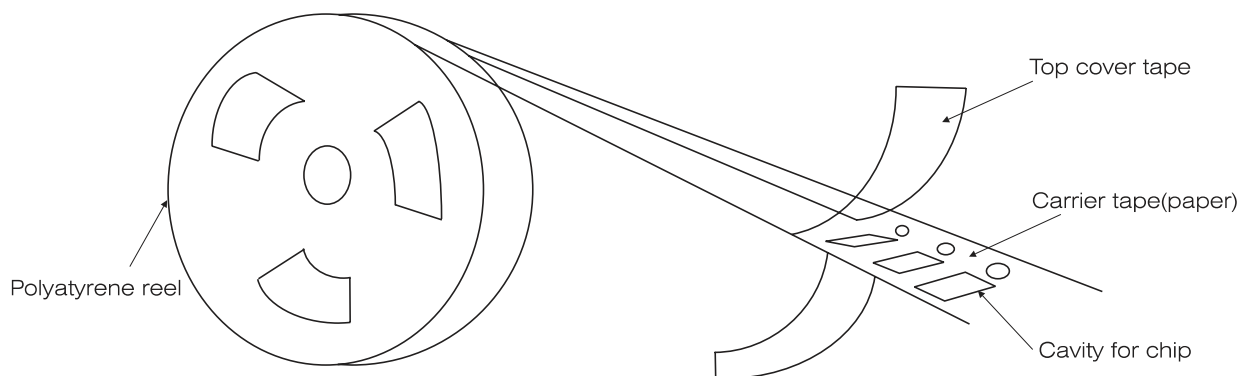

※Dimensions of paper take taping for 0402, 0603, 0805, 1206

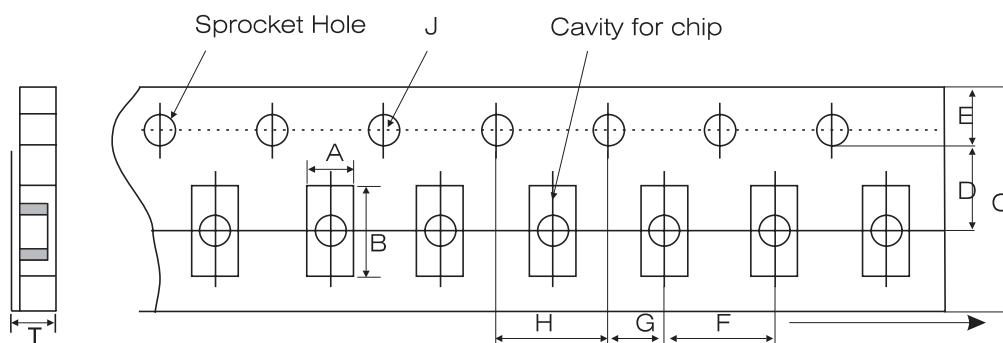

Code Paper size	A	B	C	D	E	F	G	H	J	T*
0402	0.65 ±0.10	1.15 ±0.10	8.00 ±0.10	3.50 ±0.05	1.75 ±0.10	2.00 ±0.05	2.00 ±0.05	4.00 ±0.10	1.50-0/ +0.10	Below 0.80
0603	1.10 ±0.20	1.90 ±0.20	8.00 ±0.20	3.50 ±0.05	1.75 ±0.10	4.00 ±0.10	2.00 ±0.10	4.00 ±0.10	1.50-0/ +0.10	Below 1.10
0805	1.45 ±0.20	2.30 ±0.20	8.00 ±0.20	3.50 ±0.05	1.75 ±0.10	4.00 ±0.10	2.00 ±0.10	4.00 ±0.10	1.50-0/ +0.10	Below 1.10
1206	1.80 ±0.20	3.40 ±0.20	8.00 ±0.20	3.50 ±0.05	1.75 ±0.10	4.00 ±0.10	2.00 ±0.10	4.00 ±0.10	1.50-0/ +0.10	Below 1.10

多层片式陶瓷电容器

MULTILAYER CHIP CERAMIC CAPACITOR

■ 包装

- 纸带卷盘结构

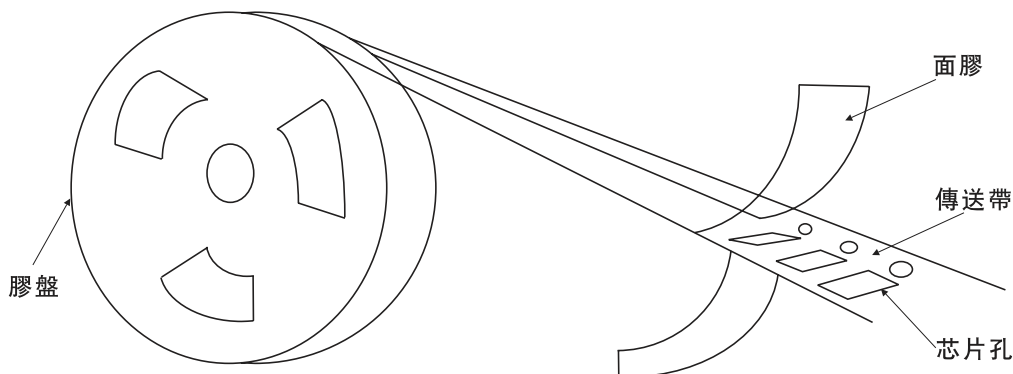

* 适合0805, 1206, 1210, 1808, 1812常规尺寸产品的塑胶带尺寸

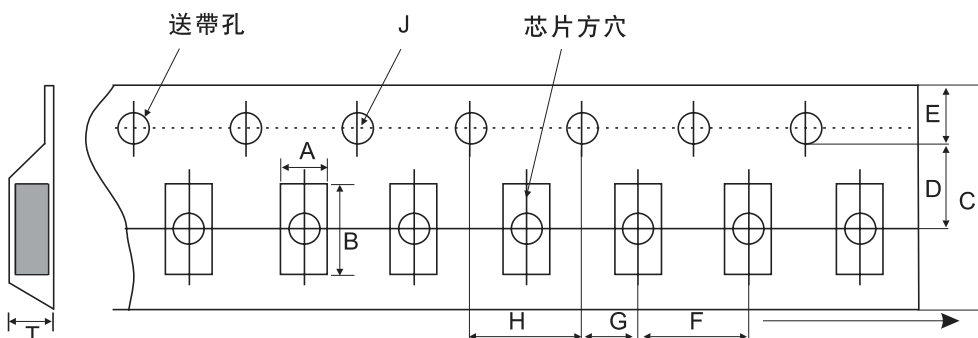

代號 紙帶規格	A	B	C	D	E	F*	G	H	J	T
0805	1.55 ±0.20	2.35 ±0.20	8.00 ±0.20	3.50 ±0.05	1.75 ±0.10	4.00 ±0.10	2.00 ±0.10	4.00 ±0.10	1.50-0/ +0.10	低于 1.50
1206	1.95 ±0.20	3.60 ±0.20	8.00 ±0.20	3.50 ±0.05	1.75 ±0.10	4.00 ±0.10	2.00 ±0.10	4.00 ±0.10	1.50-0/ +0.10	低于 1.85
1210	2.70 ±0.10	3.42 ±0.10	8.00 ±0.10	3.50 ±0.05	1.75 ±0.10	4.00 ±0.10	2.00 ±0.05	4.00 ±0.10	1.50-0/ +0.10	低于 3.2
1808	2.20 ±0.10	4.95 ±0.10	12.00 ±0.10	5.50 ±0.05	1.75 ±0.10	4.00 ±0.10	2.00 ±0.05	4.00 ±0.10	1.50-0/ +0.10	低于 3.0
1812	3.66 ±0.10	4.95 ±0.10	12.00 ±0.10	5.50 ±0.05	1.75 ±0.10	8.00 ±0.10	2.00 ±0.05	4.00 ±0.10	1.50-0/ +0.10	低于 4.0

注意:*表示此處對尺寸的要求非常精確

WEB www.nscn.com.cn

TEL +86-025-84712762 84712971 84712745

• Embossed Taping

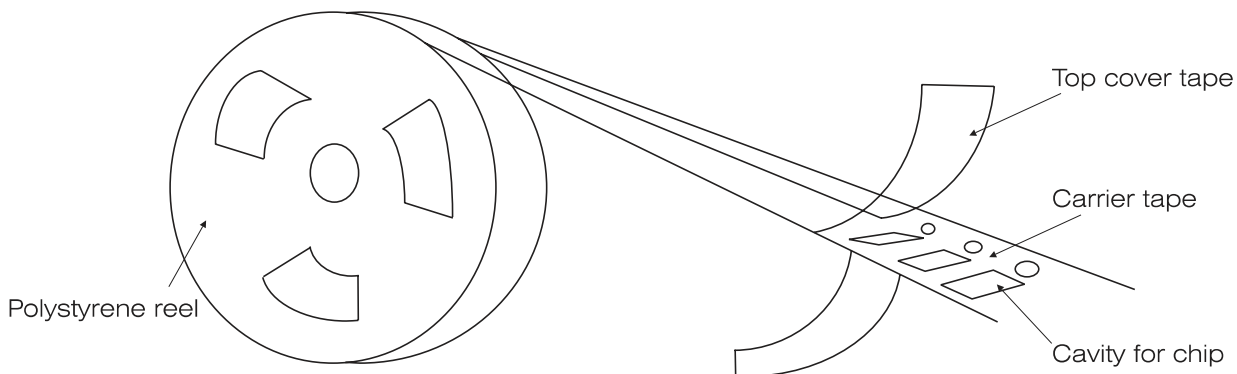

※Dimensions of embossed taping for 0805, 1206, 1210, 1808, 1812 type

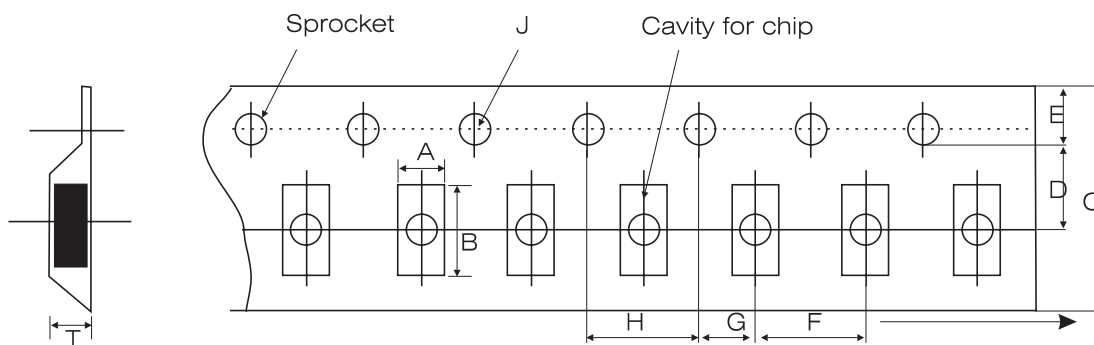

Code Tape size	A	B	C	D	E	F*	G	H	J	T
0805	1.55 ±0.20	2.35 ±0.20	8.00 ±0.20	3.50 ±0.05	1.75 ±0.10	4.00 ±0.10	2.00 ±0.10	4.00 ±0.10	1.50-0/ +0.10	低于 1.50
1206	1.95 ±0.20	3.60 ±0.20	8.00 ±0.20	3.50 ±0.05	1.75 ±0.10	4.00 ±0.10	2.00 ±0.10	4.00 ±0.10	1.50-0/ +0.10	低于 1.85
1210	2.70 ±0.10	3.42 ±0.10	8.00 ±0.10	3.50 ±0.05	1.75 ±0.10	4.00 ±0.10	2.00 ±0.05	4.00 ±0.10	1.50-0/ +0.10	低于 3.2
1808	2.20 ±0.10	4.95 ±0.10	12.00 ±0.10	5.50 ±0.05	1.75 ±0.10	4.00 ±0.10	2.00 ±0.05	4.00 ±0.10	1.50-0/ +0.10	低于 3.0
1812	3.66 ±0.10	4.95 ±0.10	12.00 ±0.10	5.50 ±0.05	1.75 ±0.10	8.00 ±0.10	2.00 ±0.05	4.00 ±0.10	1.50-0/ +0.10	低于 4.0

Note: The place with "*" means where needs exactly dimensions.

多层片式陶瓷电容器

MULTILAYER CHIP CERAMIC CAPACITOR

• 傳送帶的前后結構

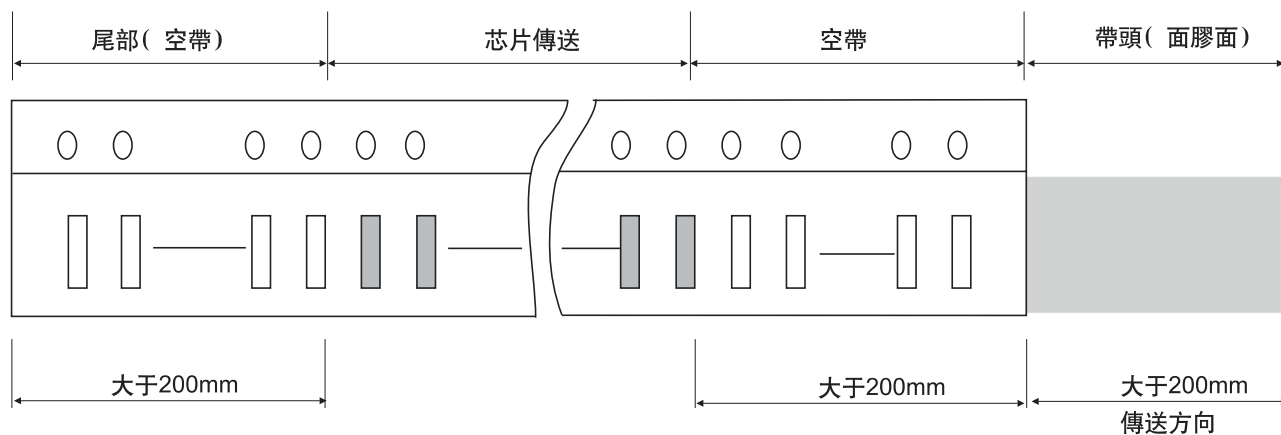

• 卷盤尺寸(單位:mm)

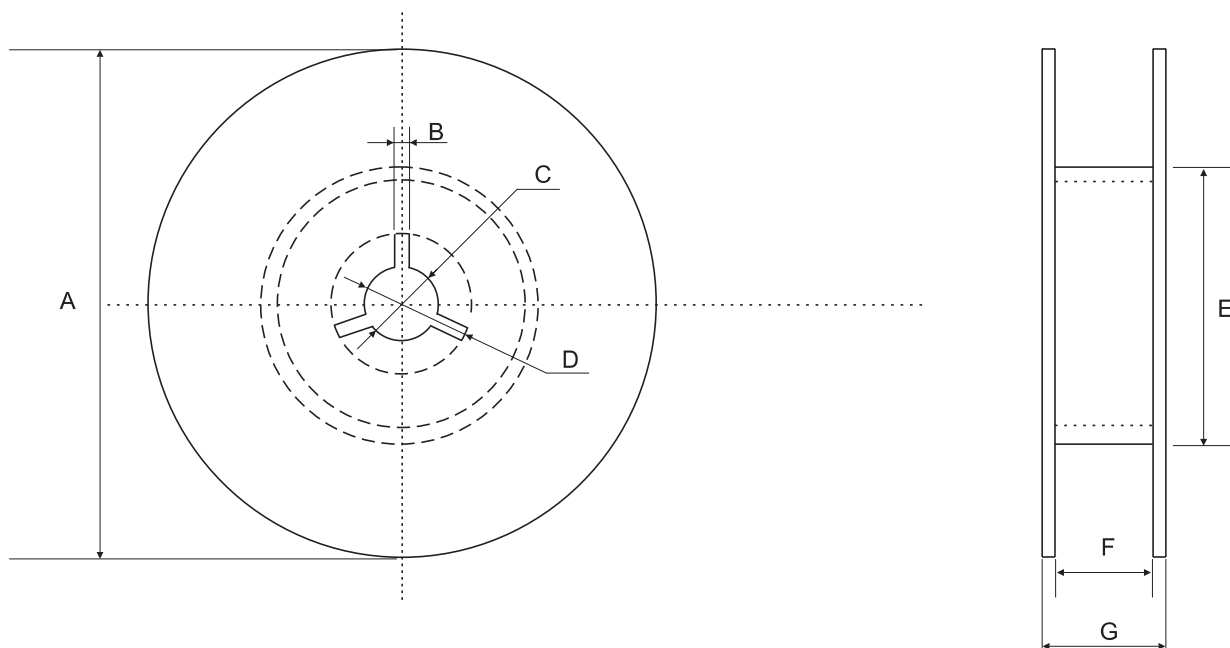

• 尺寸代碼

A	B	C	D	E	F	G
Φ178.00 ± 2.00	3.00	Φ13.00 ± 0.50	Φ21.00 ± 0.80	Φ50.00或更大	10.00 ± 1.50	12MAX
Φ330.00 ± 2.00	3.00	Φ13.00 ± 0.50	Φ21.00 ± 0.80	Φ50.00或更大	10.00 ± 1.50	12MAX



- Structure of leader part and end part of the carrier paper

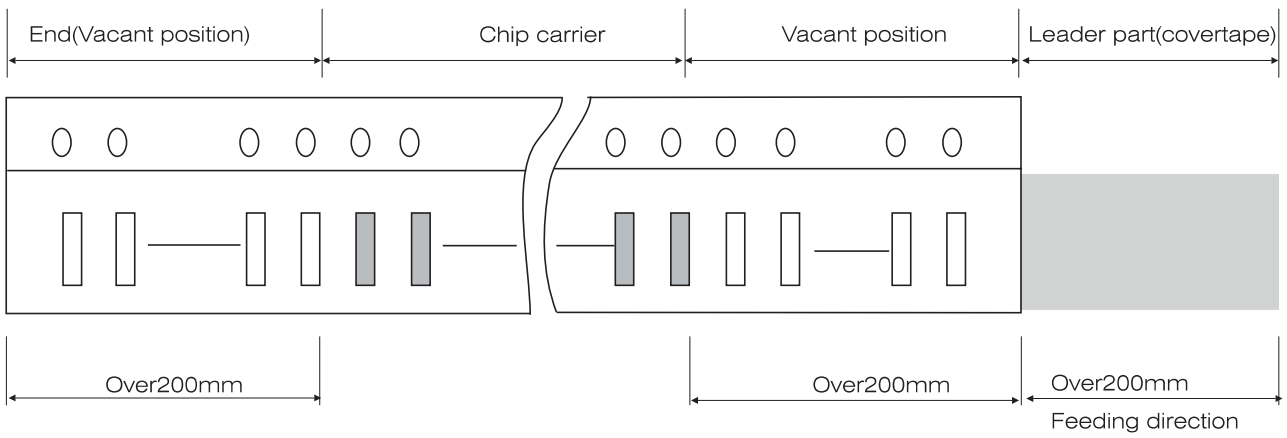

- Reel Dimensions (unit:mm)

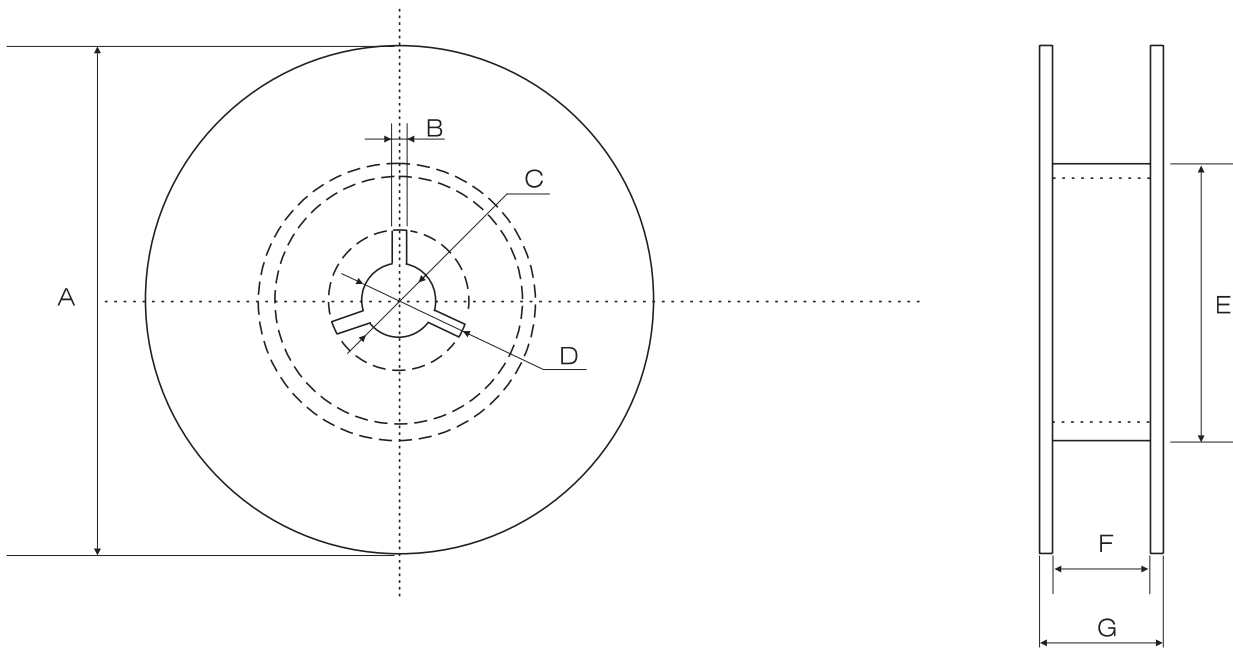

- Code

A	B	C	D	E	F	G
Φ178.00±2.00	3.00	Φ13.00±0.50	Φ21.00±0.80	Φ50.00 or max	10.00±1.50	12MAX
Φ330.00±2.00	3.00	Φ13.00±0.50	Φ21.00±0.80	Φ50.00 or max	10.00±1.50	12MAX

多层片式陶瓷电容器

MULTILAYER CHIP CERAMIC CAPACITOR

■ 关于卷带的说明

- 面胶剥离强度

(A) 纸带

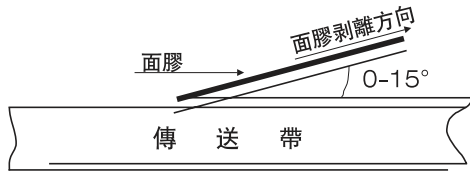

(B) 塑料胶盘

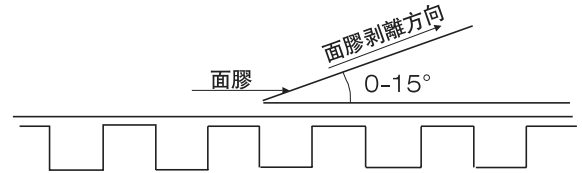

标准：0.1N < 剥离强度 < 0.7N；在剥离时，纸带不能有纸碎，也不能粘在底、面胶上。

- 塑料盒散包装

标示	A	B	T	C	D	E
尺寸	6.80±0.10	8.80±1.00	12.00±0.10	15.00+0.10/-0	2.00±0/-0.10	4.70±0.10
标示	F	W	G	H	L	I
尺寸	31.50+0.20/-0	36.00+0/-0.2	19.00±0.35	7.00±0.35	110.00±0.70	5.00±0.35

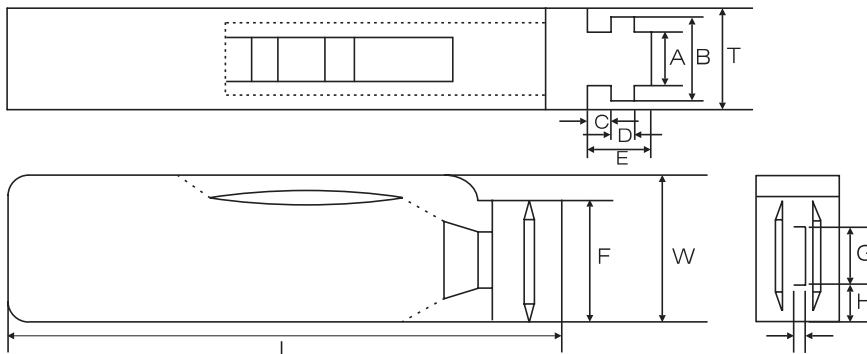

- 包装数量

尺寸	包装形式和数量			
	纸带卷盘	胶带卷盘	塑料盒散装	一般散装
0402	10000		20000	5000
0603	4000		15000	5000
0805	4000	3000	10000	5000
1206	4000	T ≤ 1.35mm 3000 T > 1.35mm 2000	5000	5000
1210		T ≤ 1.80mm 2000 T > 1.80mm 1000		2000
1808		2000		2000
1812		T ≤ 1.85mm 1000 T > 1.85mm 500		2000
2225		500		500
3035		500		

注意：包装的形式和数量可根据客户的要求来定。

■ TAPING SPECIFICATION

- Top cover tape peeling strength

(A) Paper Taping

(b) Cover tape peeling direction

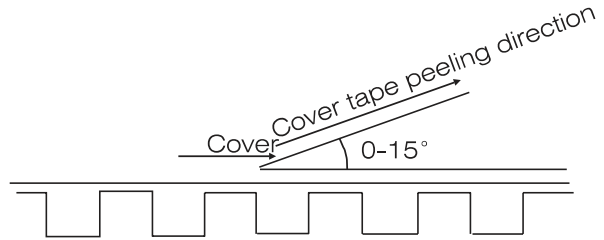
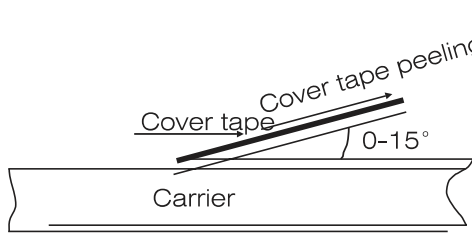

Standard: $0.1N < \text{peeling forc} < 0.7N$;
No paper dirty remains on the scotch when peeling, and no sticks to top and bottom cover tape.

- Bulk Case Package

Symbol	A	B	T	C	D	E
Dimension	6.80 ± 0.10	8.80 ± 1.00	12.00 ± 0.10	$15.00 + 0.10 / -1$	$2.00 \pm 0 / -0.10$	4.70 ± 0.10
Symol	F	W	G	H	L	I
Dimension	$31.50 + 0.20 / -0$	$36.00 + 0 / -0.2$	19.00 ± 0.35	7.00 ± 0.35	110.00 ± 0.70	5.00 ± 0.35

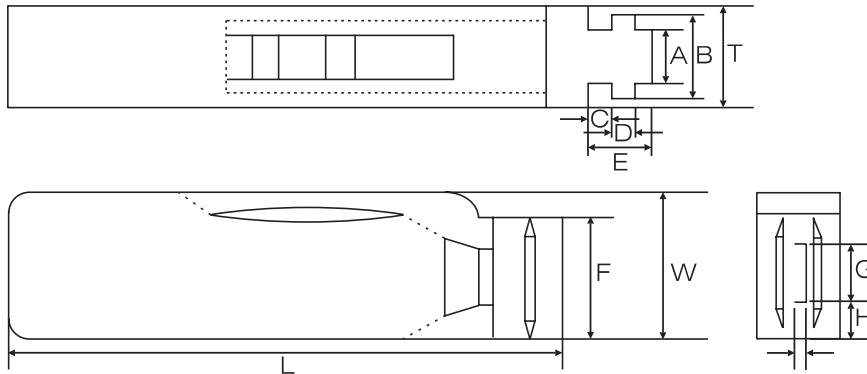

- Pack Quantity

Size	Pakaging method and quantity			
	Paper tape taping	Plastistic embossed taping	Bulk plastic box packaging	Normal bulk packaging
0402	10000		20000	5000
0603	4000		15000	5000
0805	4000	3000	10000	5000
1206	4000	$T \leq 1.35\text{mm}$ 3000 $T > 1.35\text{mm}$ 2000	5000	5000
1210		$T \leq 1.80\text{mm}$ 2000 $T > 1.80\text{mm}$ 1000		2000
1808		2000		2000
1812		$T \leq 1.85\text{mm}$ 1000 $T > 1.85\text{mm}$ 500		2000
2225		500		500
3035		500		

Note: We can choose packing style and quantity can be according to the customer's requirement.