

1. INSTRUCTION:

THIS SHEET IS THE STATEMENT OF THE THICK FILM CHIP RESISTORS SPECIFICATION THAT ROYALOHM'S PRODUCTIONS CAN MEET.

2. RATING:

TYPE		0402	0603	0805	1206	1210	2010	2512
POWER RATING		1/16W	1/10W	1/8W	1/4W	1/3W	3/4W	1W
MAX.WORKING VOLTAGE		50V	50V	150V	200V	200V	200V	200V
MAX. OVERLOAD VOLTAGE		100V	100V	300V	400V	400V	400V	400V
DIELECTRIC WITHSTANDING VOLTAGE		0402: 100V; 0603: 300V; 其余: 500V						
RESISTANCE RANGE	±1%	0402 : 100Ω--1MΩ ; 其余 10Ω--1MΩ						
	±5%	0402 : 100Ω--1MΩ ; 其余 1Ω--10MΩ						
TOLERANCE		±1%, ±5%						
RATED AMBIENT TEMP.		70°C						
TEMP.RANGE		-55°C --- +155°C						

2.1 POWER RATING:

RESISTORS SHALL HAVE A POWER RATING BASED ON CONTINUOUS LOAD OPERATION AT AN AMBIENT TEMPERATURE OF 70⁰C. FOR TEMPERATURE IN EXCESS OF 70⁰C, THE LOAD SHALL BE DERATE AS SHOWN IN FIGURE 1.

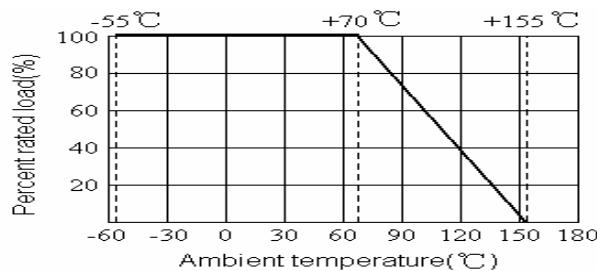
FIGURE 1**2.2 VOLTAGE RATING:**

RESISTORS SHALL HAVE A RATED DIRECT-CURRENT (DC) CONTINUOUS WORKING VOLTAGE OR AN APPROXIMATE SINE-WAVE ROOT-MEAN-SQUARE (RMS) ALTERNATING-CURRENT (AC) CONTINUOUS WORKING VOLTAGE AT COMMERCIAL-LINE FREQUENCY AND WAVEFORM CORRESPONDING TO THE POWER RATING, AS DETERMINED FROM THE FOLLOWING FORMULA:

$$RCWV = \sqrt{P \times R}$$

WHERE: RCWV = RATED DC OR RMS AC CONTINUOUS WORKING VOLTAGE AT COMMERCIAL-LINE FREQUENCY AND WAVEFORM (VOLT.)

P = POWER RATING (WATT.)

R = NOMINAL RESISTANCE (OHM)

IN NO CASE SHALL THE RATED DC OR RMS AC CONTINUOUS WORKING VOLTAGE BE GREATER THAN THE APPLICABLE MAXIMUM VALUE.

THICK FILM CHIP RESISTORS

3. DIMENSION FOR CHIP:

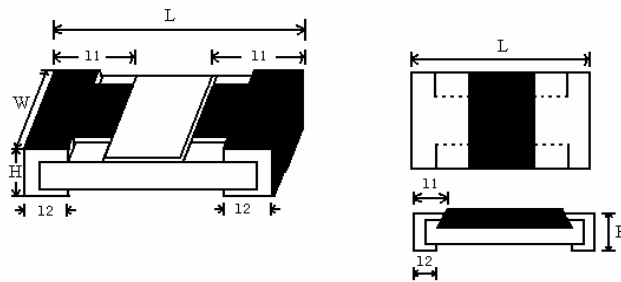

DIMENSION: mm

TYPE	L	W	H	l_1	l_2
0402	1.00 ± 0.10	$0.50^{+0.05}_{-0.05}$	0.35 ± 0.05	0.20 ± 0.10	0.25 ± 0.10
0603	1.60 ± 0.10	$0.80^{+0.15}_{-0.10}$	0.45 ± 0.10	0.30 ± 0.20	0.30 ± 0.20
0805	2.00 ± 0.15	$1.25^{+0.15}_{-0.10}$	0.55 ± 0.10	0.40 ± 0.20	0.40 ± 0.20
1206	3.10 ± 0.15	$1.55^{+0.15}_{-0.10}$	0.55 ± 0.10	0.45 ± 0.20	0.45 ± 0.20
1210	3.10 ± 0.15	$2.60^{+0.15}_{-0.10}$	0.55 ± 0.10	0.50 ± 0.25	0.50 ± 0.20
2010	5.00 ± 0.15	$2.50^{+0.15}_{-0.10}$	0.55 ± 0.10	0.60 ± 0.25	0.50 ± 0.20
2512	6.35 ± 0.15	$3.20^{+0.15}_{-0.10}$	0.55 ± 0.10	0.60 ± 0.20	0.50 ± 0.20

4. STRUCTURE:

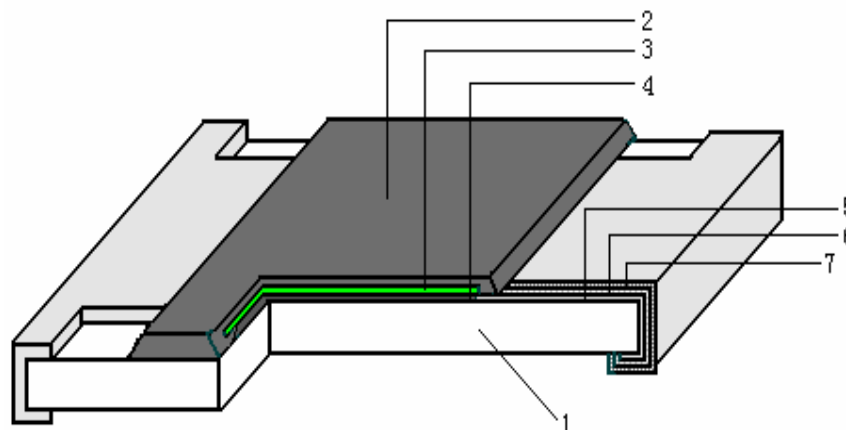

1: HIGH PURITY ALUMINA SUBSTRATE

($96\% \text{Al}_2\text{O}_3$, $0.3 \pm 0.1\% \text{CaO}$, $1.0 \pm 0.3\% \text{MgO}$, $2.1 \pm 0.05\% \text{SiO}_2$)

2,3: PROTECTIVE COVERING

4: RESISTIVE COVERING

5: TERMINATION (INNER) Ag/Pd

6: TERMINATION (BETWEEN) Ni PLATING

7: TERMINATION (OUTER) Sn PLATING

THICK FILM CHIP RESISTORS

5. **MARKING:**

(1) FOR 0402 SIZE. DUE TO THE VERY SMALL SIZE OF THE RESISTOR'S BODY, THERE IS NO MARKING ON THE BODY.

(2) $\pm 5\%$ TOLERANCE: THE FIRST TWO DIGITS ARE SIGNIFICANT FIGURES OF RESISTANCE AND THE THIRD DENOTES NUMBER OF ZEROS FOLLOWING

EXAMPLE:

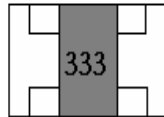

33000 \rightarrow 33K Ω

(3) $\pm 5\%$ TOLERANCE: BELOW 10 Ω SHOW AS FOLLOWING

EXAMPLE:

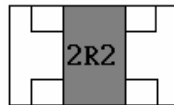

2.2 Ω

(4) $\pm 1\%$ TOLERANCE: 4 DIGITS, FIRST THREE DIGITS ARE SIGNIFICANT, FOURTH DIGIT IS NUMBER OF ZEROS. LETTER R IS DECIMAL POINT.

EXAMPLE:

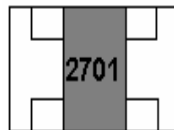

2700 \rightarrow 2.7K Ω

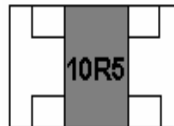

10.5 Ω

(5) STANDARD E-96 SERIES VALUES ($\pm 1\%$ TOLERANCE) OF 0603 SIZE. DUE TO THE SMALL SIZE OF THE RESISTOR'S BODY, 3 DIGITS MARKING WILL BE USED TO INDICATE THE ACCURATE RESISTANCE VALUE BY USING THE FOLLOWING MULTIPLIER & RESISTANCE CODE.

MULTIPLIER CODE:

CODE	A	B	C	D	E	F	G	H	X	Y	Z
MULTIPLIER	10 ⁰	10 ¹	10 ²	10 ³	10 ⁴	10 ⁵	10 ⁶	10 ⁷	10 ⁻¹	10 ⁻²	10 ⁻³

CODING FORMULA

FIRST TWO DIGITS-----RESISTANCE CODE

THIRD DIGIT-----MULTIPLIER CODE

EXAMPLE : 1.96K Ω =196 \times 10¹ Ω =29B 12.4 Ω =124 \times 10⁻¹ Ω =10X

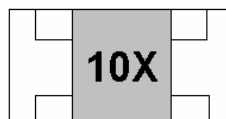
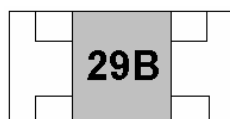

THICK FILM CHIP RESISTORS

STANDARD E-96 VALUES AND 0603 RESISTANCE CODE

Ω VALUE	CODE	Ω VALUE	CODE	Ω VALUE	CODE	Ω VALUE	CODE
100	01	178	25	316	49	562	73
102	02	182	26	324	50	576	74
105	03	187	27	332	51	590	75
107	04	191	28	340	52	604	76
110	05	196	29	348	53	619	77
113	06	200	30	357	54	634	78
115	07	205	31	365	55	649	79
118	08	210	32	374	56	665	80
121	09	215	33	383	57	681	81
124	10	221	34	392	58	698	82
127	11	226	35	402	59	715	83
130	12	232	36	412	60	732	84
133	13	237	37	422	61	750	85
137	14	243	38	432	62	768	86
140	15	249	39	442	63	787	87
143	16	255	40	453	64	806	88
147	17	261	41	464	65	825	89
150	18	267	42	475	66	845	90
154	19	274	43	487	67	866	91
158	20	280	44	499	68	887	92
162	21	287	45	511	69	909	93
165	22	294	46	523	70	931	94
169	23	301	47	536	71	953	95
174	24	309	48	549	72	976	96

THICK FILM CHIP RESISTORS

6. CHARACTERISTICS:

CHARACTERISTIC	LIMITS		TEST METHOD (JIS-C-5201/5202)
TEMPERATURE COEFFICIENT	±1%	10Ω---100Ω≤±200PPM/°C 101Ω---1MΩ≤±100PPM/°C	5.2 NATURAL RESISTANCE CHANGE PER TEMP. DEGREE CENTIGRADE $\frac{R_2-R_1}{R_1(T_2-T_1)} \times 10^6$ (PPM/°C) R ₁ (T ₂ -T ₁) R ₁ : RESISTANCE VALUE AT ROOM TEMP. (T ₁) R ₂ : RESISTANCE VALUE AT ROOM TEMP. +100°C (T ₂) TEST PATTERN: ROOM TEMP., ROOM TEMP. +100°C
	±5%	1Ω---10Ω≤±400PPM/°C 11Ω---10MΩ≤±200PPM/°C	
SHORT-TIME OVERLOAD	±1%	±(1%+0.1 Ω) MAX.	5.5 PERMANENT RESISTANCE CHANGE AFTER THE APPLICATION OF 2.5 TIMES RCWV FOR 5 SECONDS.
	±5%	±(2%+0.1 Ω) MAX	
INSULATION RESISTANCE	1,000 M Ω OR MORE		5.6 APPLY 500V DC BETWEEN PROTECTIVE COATING AND TERMINATION FOR 1 MINUTE, THEN MEASURE.
DIELECTRIC WITHSTANDING VOLTAGE	NO EVIDENCE OF FLASHOVER MECHANICAL DAMAGE, ARCING OR INSULATION BREAK DOWN.		5.7 APPLY 500V DC BETWEEN PROTECTIVE COATING AND TERMINATION FOR 1 MINUTE
TERMINAL BENDING	±(1%+0.05 Ω) MAX		6. 1.4 TWIST OF TEST BOARD: Y/X = 3/90 mm FOR 10 SECONDS
SOLDERING HEAT	RESISTANCE CHANGE RATE IS: ±(1%+0.05 Ω) MAX		6.4 DIP THE RESISTOR INTO A SOLDER BATH HAVING A TEMPERATURE OF 260°C±5°C AND HOLD IT FOR 10±1 SECONDS.

THICK FILM CHIP RESISTORS

THICK FILM CHIP RESISTORS					
CHARACTERISTIC	LIMITS		TEST METHOD (JIS-C-5201/5202)		
TEMPERATURE CYCLING	±1%	±(0.5%+0.05 Ω)MAX	7.4 RESISTANCE CHANGE AFTER CONTINUOUS FIVE CYCLES FOR DUTY CYCLE SPECIFIED BELOW:		
			STEP	TEMPERATURE	TIME
			1	-55°C ± 3°C	30 MINS
	±5%	±(1.0%+0.05 Ω)MAX.	2	ROOM TEMP.	10 --- 15 MINS
			3	+155°C ± 3°C	30 MINS
4	ROOM TEMP.	10 --- 15 MINS			
SOLDERABILITY	95% COVERAGE MIN.		6.5 TEST TEMPERATURE OF SOLDER: 245°C ± 5°C DIPPING TIME IN SOLDER: 3± 0.5 SECONDS.		
HUMIDITY (STEADY STATE)	±1%	±(0.5%+0.1 Ω) MAX.	7.5 TEMPORARY RESISTANCE CHANGE AFTER A 1,000 HOURS EXPOSURE IN A HUMIDITY CHAMBER.		
	±5%	±(3.0%+0.1 Ω) MAX.			
LOAD LIFE IN HUMIDITY	RESISTANCE CHANGE RATE IS:		7.9 RESISTANCE CHANGE AFTER 1,000 HOURS (1.5 HOURS "ON", 0.5 HOUR "OFF") AT RCWV IN A HUMIDITY CHAMBER CONTROLLED AT 40°C ± 2°C AND 90 TO 95% RELATIVE HUMIDITY.		
	±1%	±(1%+0.1Ω) MAX.			
	±5%	±(3%+0.1Ω) MAX.			
LOAD LIFE	RESISTANCE CHANGE RATE IS:		7.10 PERMANENT RESISTANCE CHANGE AFTER 1,000 HOURS OPERATING AT RCWV WITH DUTY CYCLE 1.5 HOURS "ON", 0.5 HOUR "OFF" AT 70°C ± 2°C AMBIENT.		
	±1%	±(1%+0.1Ω) MAX.			
	±5%	±(3%+0.1Ω) MAX.			

THICK FILM CHIP RESISTORS

7. PACKAGING:

7.1 TAPPING DIMENSION:

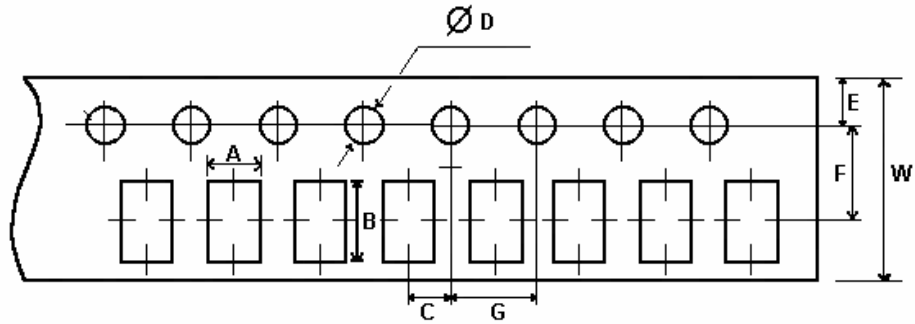

UNIT: mm

TYPE	A ± 0.2	B ± 0.2	C ± 0.05	φD + 0.1 - 0	E ± 0.1	F ± 0.05	G ± 0.1	W ± 0.2
0402	0.65	1.15	2.0	1.5	1.75	3.5	4.0	8.0
0603	1.10	1.90	2.0	1.5	1.75	3.5	4.0	8.0
0805	1.65	2.40	2.0	1.5	1.75	3.5	4.0	8.0
1206	2.00	3.60	2.0	1.5	1.75	3.5	4.0	8.0
1210	2.80	3.50	2.0	1.5	1.75	3.5	4.0	8.0
2010	2.9	5.6	2.0	1.5	1.75	5.5	4.0	12.0
2512	3.5	6.7	2.0	1.5	1.75	5.5	4.0	12.0

7.2 DIMENSION:

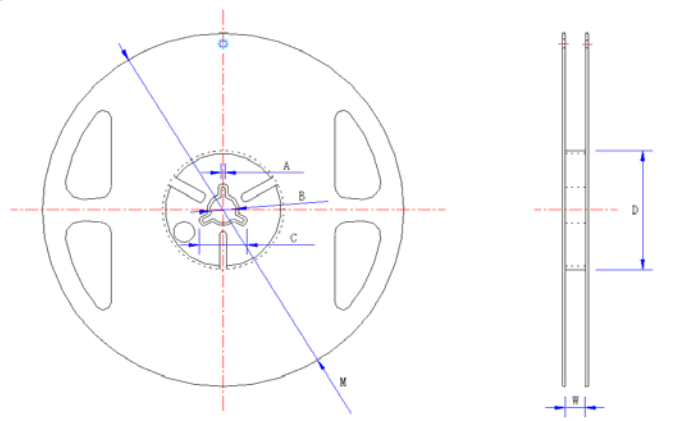

UNIT: mm

TYPE	TAPING	QUANTITY	A ± 0.5	B ± 0.5	C ± 0.5	D ± 1	M ± 2	W ± 1
0402	PAPER	10,000 PCS REEL	2.0	13.0	21.0	60.0	178	10
0603	PAPER	5,000 PCS REEL	2.0	13.0	21.0	60.0	178	10
0805	PAPER	5,000 PCS REEL	2.0	13.0	21.0	60.0	178	10
1206	PAPER	5,000 PCS REEL	2.0	13.0	21.0	60.0	178	10
1210	PAPER	5,000 PCS REEL	2.0	13.0	21.0	60.0	178	10
2010	Embossed	4,000 PCS REEL	2.0	13.0	21.0	60.0	178	13.8
2512	Embossed	4,000 PCS REEL	2.0	13.0	21.0	60.0	178	13.8

PART NUMBER SYSTEM

EXPLANATION OF PART NUMBER SYSTEM (THICK FILM CHIP RESISTORS)

ORDERING PROCEDURE (EXAMPLE: 1206 1/4W 5% 100 Ω T/R-5000):

1	2	0	6	W	4	J	0	1	0	1	T	5	E
---	---	---	---	---	---	---	---	---	---	---	---	---	---

