

## 引线 瞬态抑制二极管 Transient Voltage Suppressor Diode

### 简介:

TVS DIODE:瞬态抑制二极管是一种限压型的过电压保护器件,它又叫 TVP、ABD, 它能以 PS 级的速度把过高的电压限制在一个安全范围之内,从而起到保护后面电路的作用。广泛应用在半导体及敏感的电子零件过电压、ESD 保护, 主要包括: 消费类产品、工业产品、通讯、计算机、汽车、电源供应品、信号线路保护及军事、航天航空导航系统及控制系统上;反应速度快, 电压抑制能力强, 有 Axial lead 和 SMD 系列.

产品通过一系列的安全可靠认证如 UL 认证、无铅认证, 符合 IEC61000-4-2 ESD、IEC 61643-321:2001 ABD 测试标准。

### 特点:

- TVS 组件, 反应速度快
- 瞬态功率从 400W 至 30,000W;
- 电压由 5V 至 600V, 或更高, 也可为客户定制规格

### TVS 典型应用电路:

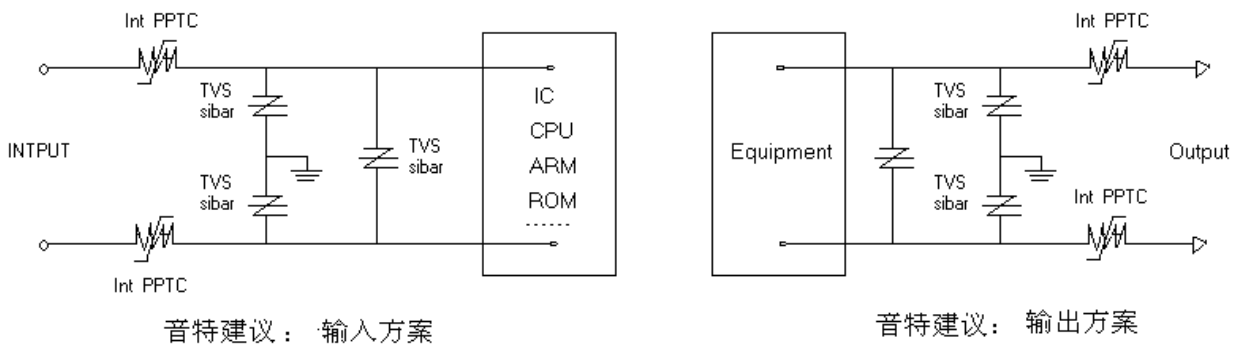

## 600W Surface Mount Transient Voltage Suppressor

### SMBJ5.0~SMBJ188CA /SMB Do-214AA

#### 电气特性 Specification

型号 TYPE CA: BI-polar A: Uni-polar	反向关断电 压 V(RWM)	击穿电压 V(BR)		测试电流 I(T)	=Vrwm 最大 反向漏电流 Ir	最大峰值 脉冲电流 Ipp	=Ipp 嵌位电 压值 Vc
		Min .V	Max .V				
SMBJ5.0(C)A	5.0	6.4	7.25	10	800	65.2	9.2
SMBJ6.0(C)A	6.0	6.67	7.67	10	800	58.3	10.3
SMBJ 6.5(C)A	6.5	7.22	8.30	10	500	53.6	11.2
SMBJ7.0 (C)A	7.0	7.78	8.95	10	200	50.0	12.0
SMBJ 7.5(C)A	7.5	8.33	9.58	1	100	46.6	12.9
SMBJ 8.0(C)A	8.0	8.89	10.23	1	50	44.1	13.6
SMBJ8.5 (C)A	8.5	9.44	10.82	1	20	41.7	14.4
SMBJ9.0 (C)A	9.0	10.00	11.50	1	10	39.0	15.4
SMBJ10(C)A	10.0	11.1	12.3	1	10	35.3	17.0
SMBJ11(C)A	11.0	12.20	14.00	1	5	33.0	18.2
SMBJ12(C)A	12.0	13.3	14.7	1	5	30.2	19.9
SMBJ13(C)A	13.0	14.40	16.50	1	5	27.9	21.5
SMBJ14(C)A	14.0	15.60	17.2	1	5	25.9	23.2
SMBJ15(C)A	15.0	16.70	19.20	1	5	24.6	24.4

型号 TYPE CA: BI-polar A: Uni-polar	反向关断电 压 V(RWM)	击穿电压 V(BR)		测试电流 I(T)	=Vrwm 最大 反向漏电流 Ir	最大峰值 脉冲电流 Ipp	=Ipp 嵌位电 压值 Vc
SMBJ16(C)A	16.0	17.8	19.7	1	5	23.1	26.0
SMBJ17(C)A	17.0	18.90	21.70	1	5	21.7	27.6
SMBJ18(C)A	18.0	20.00	23.30	1	5	20.5	29.2
SMBJ20(C)A	20.0	22.20	25.50	1	5	18.5	32.4
SMBJ22(C)A	22.0	24.40	28.00	1	5	16.9	35.5
SMBJ24(C)A	24.0	26.70	30.70	1	5	15.2	38.9
SMBJ26(C)A	26.0	28.90	33.20	1	5	14.2	42.1
SMBJ28(C)A	28.0	31.10	35.80	1	5	13.2	45.4
SMBJ30(C)A	30.0	33.30	38.30	1	5	12.4	48.4
SMBJ33(C)A	33.0	36.70	42.20	1	5	11.3	53.3
SMBJ36(C)A	36.0	40.00	46.00	1	5	10.3	58.1
SMBJ40(C)A	40.0	44.40	51.10	1	5	9.3	64.5
SMBJ43(C)A	43.0	47.80	52.80	1	5	8.6	69.4
SMBJ45(C)A	45.0	50.00	57.50	1	5	8.3	72.7
SMBJ48(C)A	48.0	53.3	58.9	1	5	7.8	77.4
SMBJ51(C)A	51.0	56.70	65.20	1	5	7.3	82.4
SMBJ54(C)A	54.0	60.0	66.3	1	5	6.9	87.1
SMBJ58(C)A	58.0	64.40	74.10	1	5	6.4	93.6
SMBJ60(C)A	60.0	66.7	73.7	1	5	6.2	96.8
SMBJ64(C)A	64.0	71.10	81.80	1	5	5.8	103.0
SMBJ70(C)A	70.0	77.80	89.50	1	5	5.3	113.0
SMBJ75(C)A	75.0	83.3	92.1	1	5	5.0	121.0
SMBJ78(C)A	78.0	86.70	99.70	1	5	4.7	126.0
SMBJ85(C)A	85.0	94.40	108.20	1	5	4.4	137.0
SMBJ90(C)A	90.0	100.0	111.0	1	5	4.1	146.0
SMBJ100(C)A	100.0	110.00	128.00	1	5	3.7	162.0
SMBJ110(C)A	110.0	122.00	140.50	1	5	3.4	177.0
SMBJ120(C)A	120.0	133.00	147.00	1	5	3.1	193.0
SMBJ130(C)A	130.0	144.00	165.50	1	5	2.9	209.0
SMBJ150(C)A	150.0	167.00	192.50	1	5	2.5	243.0
SMBJ160(C)A	160.0	178.00	197.00	1	5	2.3	259.0
SMBJ170(C)A	170.0	189.00	217.50	1	5	2.2	275.0
SMBJ188(C)A	188.0	209.00	231.00	1	5	1.8	328.0

产品重要特性曲线 (TA=25°C unless otherwise noted)

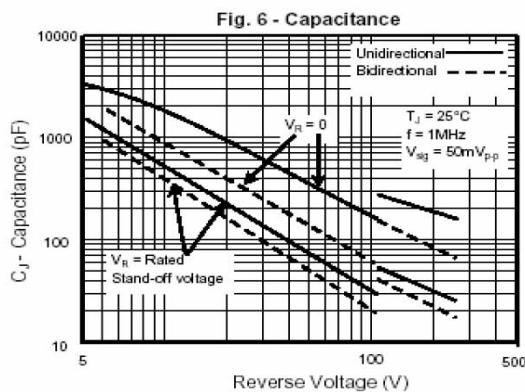
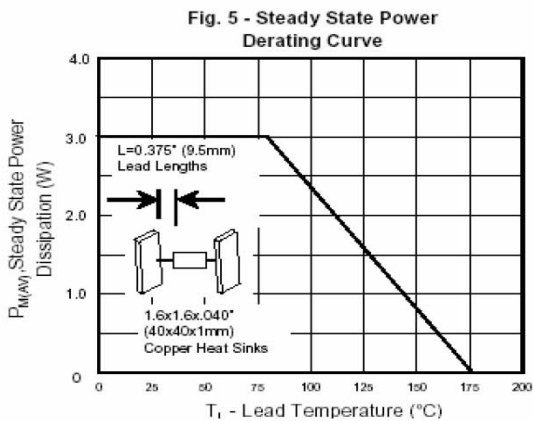
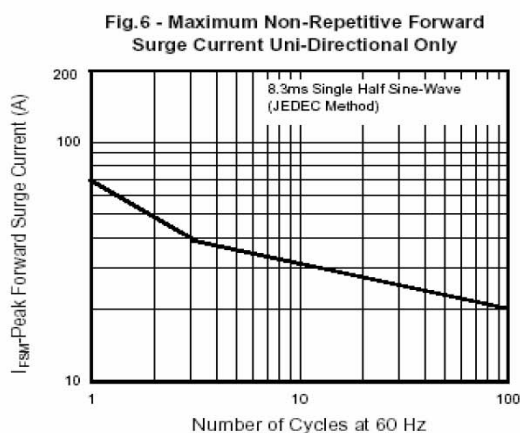
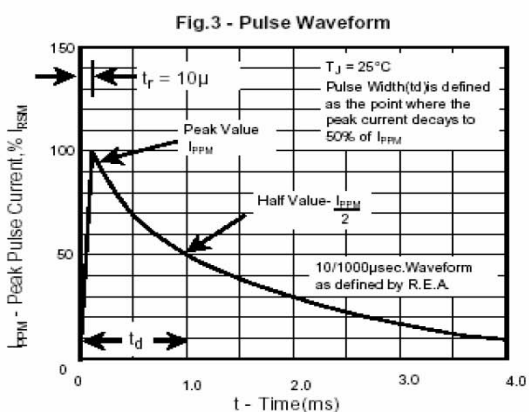
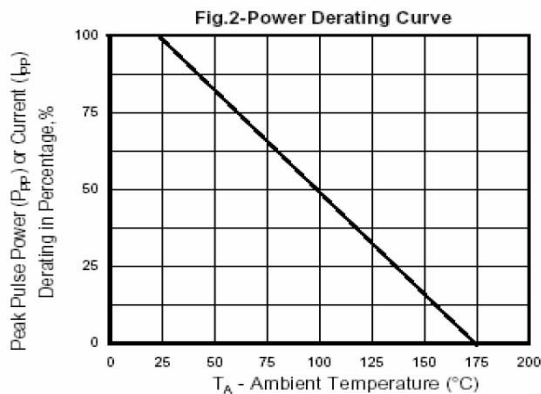
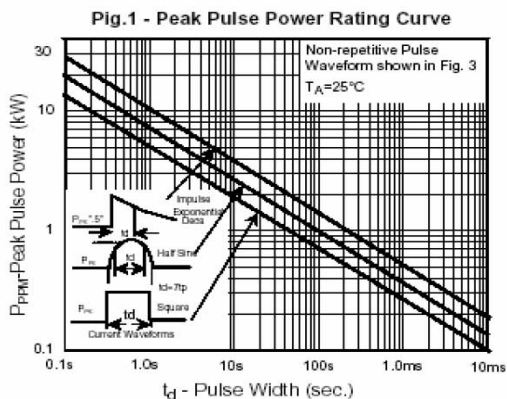

产品包装信息 Packing Information

1000PCS/Bag

10000PCS/Box