

ELCO EUROPE (A DIVISION OF AVX LTD.) CONFIDENTIAL PROPRIETARY
 THE DRAWING ON THIS PRINT AND INFORMATION THEREWITH ARE
 PROPRIETARY TO ELCO EUROPE (A DIVISION OF AVX LTD.) AND
 SHALL NOT BE USED OR DISCUSSED IN WHOLE OR IN PART
 WITHOUT ELCO EUROPE'S WRITTEN CONSENT.

00 - 9155 - 003 - 201 - XXX

PREFIX _____

SERIES _____

NO. OF WAYS _____

CODE	NO. OF WAYS
002	2
003	3
004	4
005	5

REDUCED SIZE BATTERY CONNECTOR _____

CODE	DESCRIPTION
201	REDUCED SIZE BATTERY CONNECTOR

PLATING OPTION _____

CODE	DESCRIPTION
006	0.4µm SELECTIVE GOLD, PURE TIN TAIL
008	0.8µm SELECTIVE GOLD, PURE TIN TAIL



ELCO EUROPE (A DIVISION OF AVX LTD.) CONFIDENTIAL PROPRIETARY
 THE DRAWING ON THIS PRINT AND INFORMATION THEREWITH ARE
 PROPRIETARY TO ELCO EUROPE (A DIVISION OF AVX LTD.) AND
 SHALL NOT BE USED OR DISCLOSED IN WHOLE OR IN PART
 WITHOUT ELCO EUROPE'S WRITTEN CONSENT.

SHEET 1 OF 5

FORM-106-01-056-6 ISS 7
 Release No.
 History
 101634

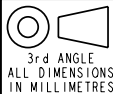

ELCO

© COPYRIGHT ELCO EUROPE
 NOT TO BE DISCLOSED OR COPIED
 WITHOUT WRITTEN PERMISSION

Drawn
 JDN

Size
 CV

9155 REDUCED SIZE - ORDERING CODE

Part Number
 00-9155-01_200S

DATE
 16-Sept-04

Issue
 C

2-WAY REDUCED SIZE BATTERY CONNECTOR

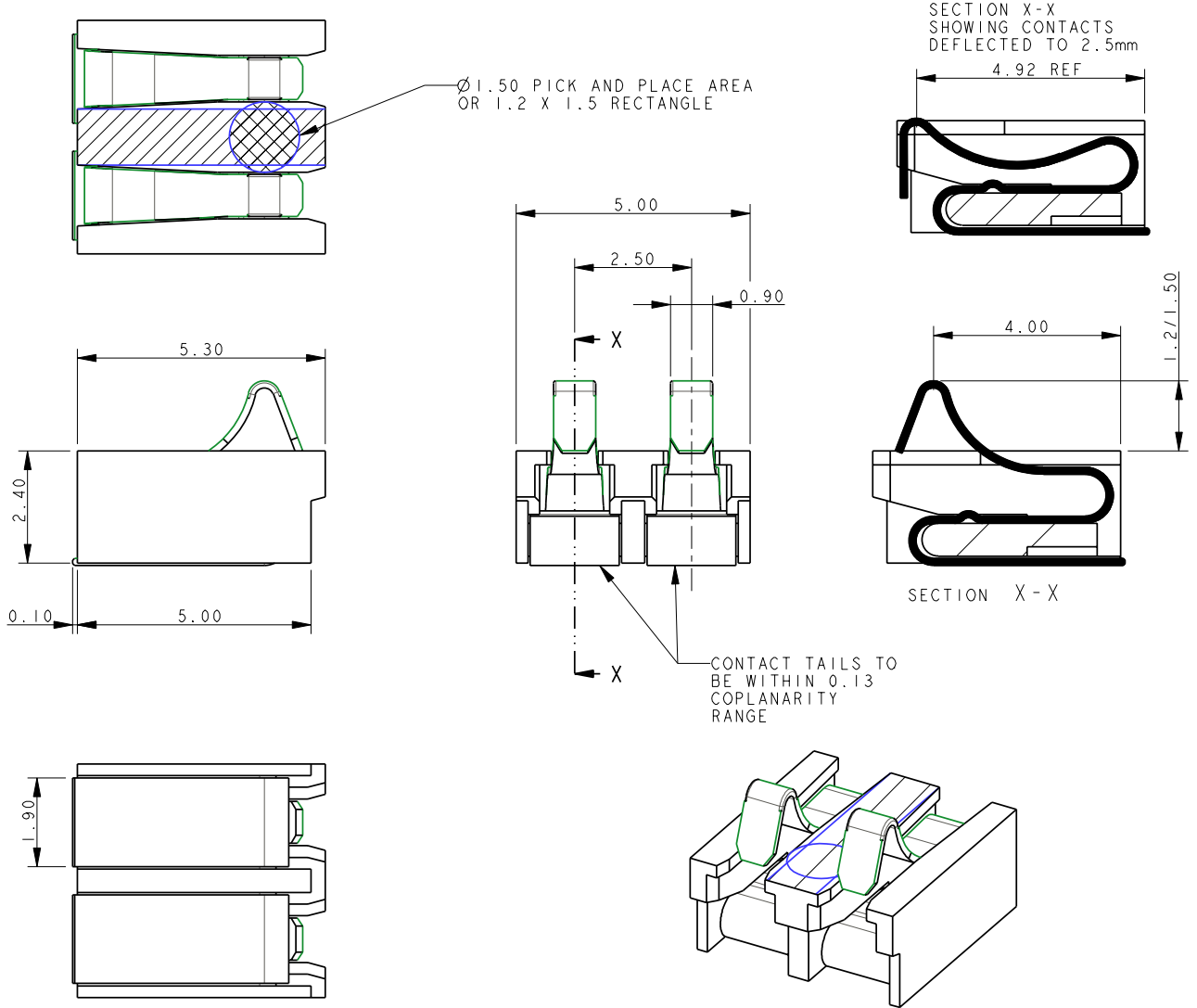

ELCO EUROPE (A DIVISION OF AVX LTD.) CONFIDENTIAL PROPRIETARY
THE DRAWING ON THIS PRINT AND INFORMATION THEREWITH ARE
PROPRIETARY TO ELCO EUROPE (A DIVISION OF AVX LTD.) AND
SHALL NOT BE USED OR DISCUSSED IN WHOLE OR IN PART
WITHOUT ELCO EUROPE'S WRITTEN CONSENT.

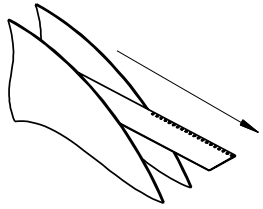

PACKING DETAILS	
REEL QTY	2000
LEADER	500mm
TRAILER	500mm
REELS/BOX	7
PACK QTY	14000

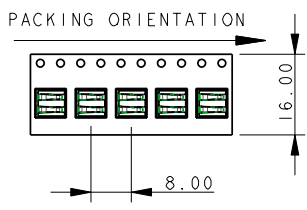

PAD AREA MAY BE REMOVED
AT CUSTOMER DISCRETION

- NOTES
- FOR FULL PRODUCT SPECIFICATION REFER TO ELCO SPECIFICATION 201-01-093
 - CRITICAL DIMENSIONS SHOWN AS :- ▲
 - GENERAL TOLERANCE ±0.2



ELCO EUROPE (A DIVISION OF AVX LTD.) CONFIDENTIAL PROPRIETARY
THE DRAWING ON THIS PRINT AND INFORMATION THEREWITH ARE
PROPRIETARY TO ELCO EUROPE (A DIVISION OF AVX LTD.) AND
SHALL NOT BE USED OR DISCUSSED IN WHOLE OR IN PART
WITHOUT ELCO EUROPE'S WRITTEN CONSENT.

3-WAY REDUCED SIZE BATTERY CONNECTOR

ELCO EUROPE (A DIVISION OF AVX LTD.) CONFIDENTIAL PROPRIETARY
 THE DRAWING ON THIS PRINT AND INFORMATION THEREWITH ARE
 PROPRIETARY TO ELCO EUROPE (A DIVISION OF AVX LTD.) AND
 SHALL NOT BE USED OR DISCUSSED IN WHOLE OR IN PART
 WITHOUT ELCO EUROPE'S WRITTEN CONSENT.

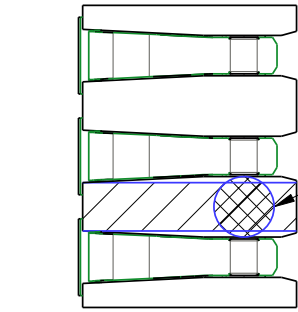

Ø1.50 PICK AND PLACE AREA
 OR 1.2 X 1.5 RECTANGLE

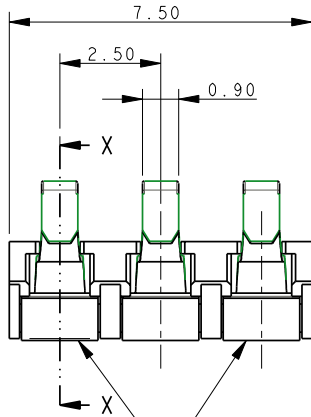
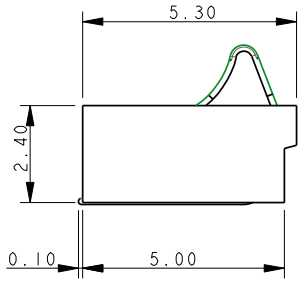

CONTACT TAILS TO
 BE WITHIN 0.13
 COPLANARITY
 RANGE

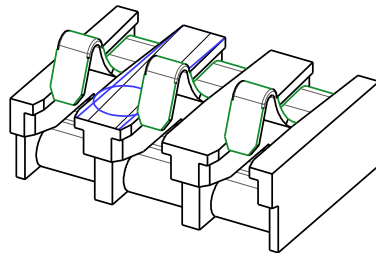

SECTION X-X
 SHOWING CONTACTS
 DEFLECTED TO 2.5mm

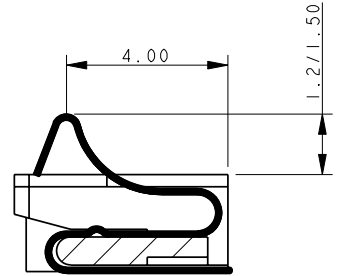
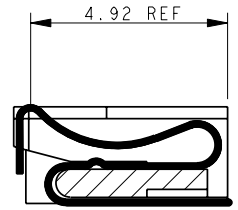

SECTION X-X

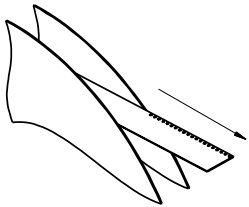
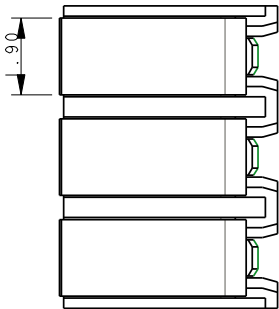

PACKING DETAILS	
REEL QTY	2000
LEADER	500mm
TRAILER	500mm
REELS/BOX	7
PACK QTY	14000-

PACKING ORIENTATION

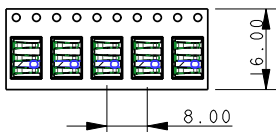

RECOMENDED PCB PAD LAYOUT

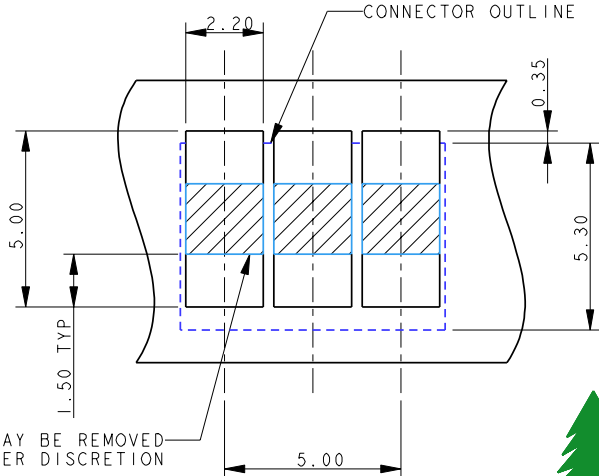

PAD AREA MAY BE REMOVED
 AT CUSTOMER DISCRETION

(NOTES

- FOR FULL PRODUCT SPECIFICATION REFER TO ELCO SPECIFICATION 201-01-093
- CRITICAL DIMENSIONS SHOWN AS :- ▲
- GENERAL TOLERANCE ±0.2



ELCO EUROPE (A DIVISION OF AVX LTD.) CONFIDENTIAL PROPRIETARY
 THE DRAWING ON THIS PRINT AND INFORMATION THEREWITH ARE
 PROPRIETARY TO ELCO EUROPE (A DIVISION OF AVX LTD.) AND
 SHALL NOT BE USED OR DISCUSSED IN WHOLE OR IN PART
 WITHOUT ELCO EUROPE'S WRITTEN CONSENT.

Release No.
 History
 101634

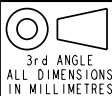

ELCO

© COPYRIGHT ELCO EUROPE
 NOT TO BE DISCLOSED OR COPIED
 WITHOUT WRITTEN PERMISSION

Drawn
 JDN
 Size
 CV

Description
 OUTLINE DRAWING

Part Number
 00-9155-01_200S

DATE
 16-Sept-04
 Issue
 C

4-WAY REDUCED SIZE BATTERY CONNECTOR

ELCO EUROPE (A DIVISION OF AVX LTD.) CONFIDENTIAL PROPRIETARY THE DRAWING ON THIS PRINT AND INFORMATION THEREWITH ARE PROPRIETARY TO ELCO EUROPE (A DIVISION OF AVX LTD.) AND SHALL NOT BE USED OR DISCUSSED IN WHOLE OR IN PART WITHOUT ELCO EUROPE'S WRITTEN CONSENT.

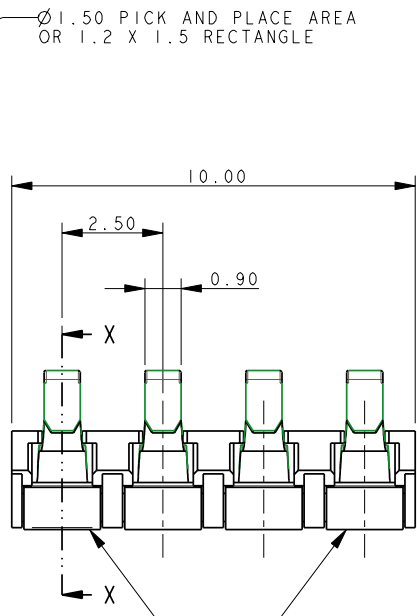
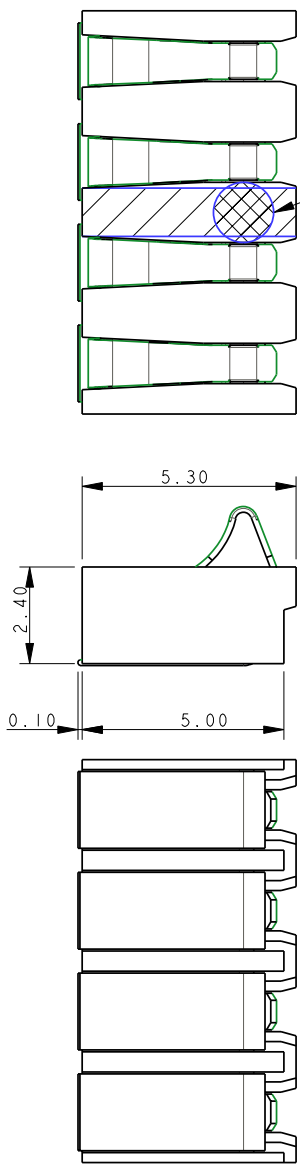

SECTION X-X
SHOWING CONTACTS
DEFLECTED TO 2.5mm

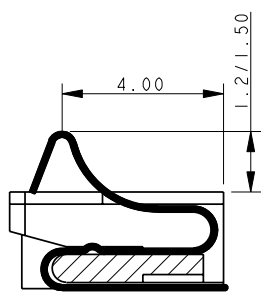
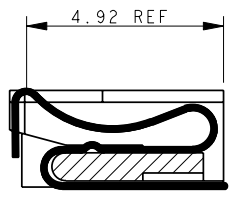

CONTACT TAILS TO BE WITHIN 0.13 COPLANARITY RANGE

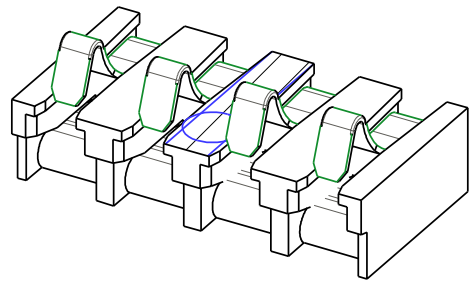

RECOMENDED PCB PAD LAYOUT

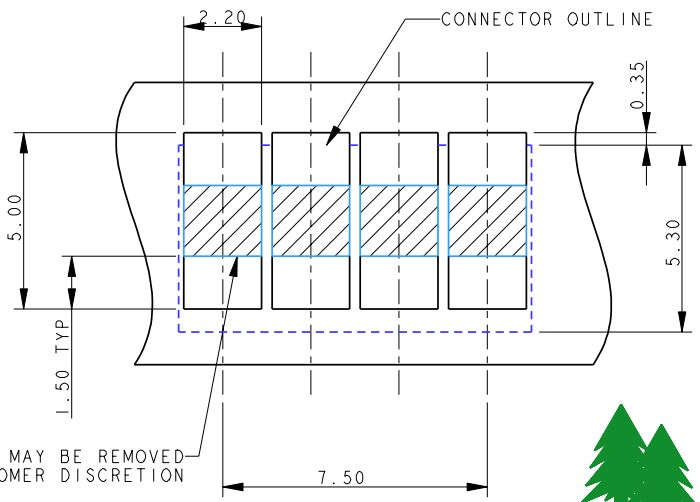

PACKING DETAILS	
REEL QTY	2000
LEADER	500mm
TRAILER	500mm
REELS/BOX	5
PACK QTY	10000

PACKING ORIENTATION

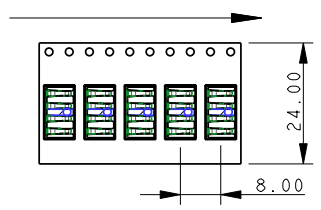
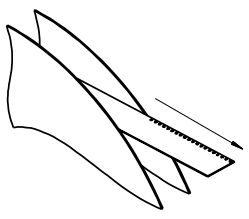

- NOTES
- FOR FULL PRODUCT SPECIFICATION REFER TO ELCO SPECIFICATION 201-01-093
 - CRITICAL DIMENSIONS SHOWN AS :- ▲
 - GENERAL TOLERANCE ±0.2

ELCO EUROPE (A DIVISION OF AVX LTD.) CONFIDENTIAL PROPRIETARY THE DRAWING ON THIS PRINT AND INFORMATION THEREWITH ARE PROPRIETARY TO ELCO EUROPE (A DIVISION OF AVX LTD.) AND SHALL NOT BE USED OR DISCUSSED IN WHOLE OR IN PART WITHOUT ELCO EUROPE'S WRITTEN CONSENT.



FORM-106-01-056-6 ISS 7

Release No.
History
101634

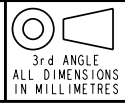

ELCO
© COPYRIGHT ELCO EUROPE
NOT TO BE DISCLOSED OR COPIED
WITHOUT WRITTEN PERMISSION

Drawn
JDN
Size
CV

Description
OUTLINE DRAWING
Part Number
00-9155-01_200S

DATE
16-Sept-04
Issue
C

5-WAY REDUCED SIZE BATTERY CONNECTOR

ELCO EUROPE (A DIVISION OF AVX LTD.) CONFIDENTIAL PROPRIETARY
 THE DRAWING ON THIS PRINT AND INFORMATION THEREWITH ARE
 PROPRIETARY TO ELCO EUROPE (A DIVISION OF AVX LTD.) AND
 SHALL NOT BE USED OR DISCUSSED IN WHOLE OR IN PART
 WITHOUT ELCO EUROPE'S WRITTEN CONSENT.

SECTION X-X
 SHOWING CONTACTS
 DEFLECTED TO 2.5mm

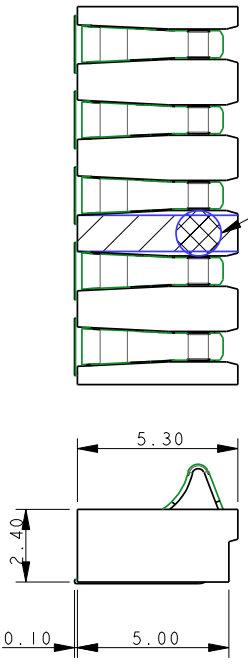

Ø1.50 PICK AND PLACE AREA
 OR 1.2 X 1.5 RECTANGLE

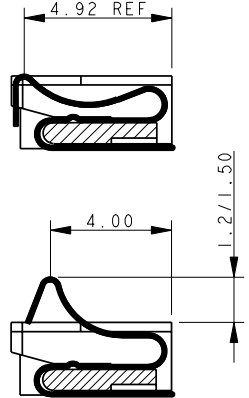
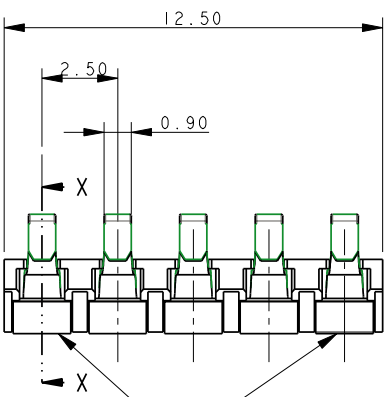

CONTACT TAILS TO
 BE WITHIN 0.13
 COPLANARITY
 RANGE

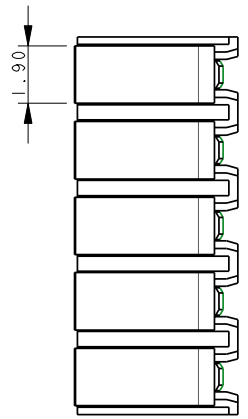
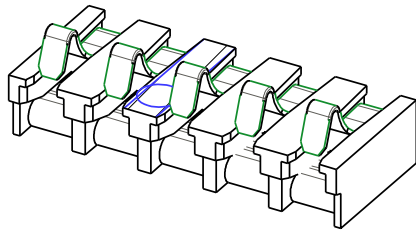

PACKING DETAILS	
REEL QTY	2000
LEADER	500mm
TRAILER	500mm
REELS/BOX	5
PACK QTY	10000

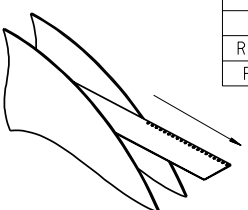

PACKING ORIENTATION

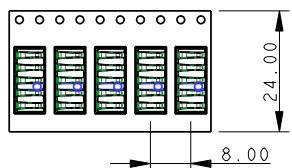

RECOMENDED PCB PAD LAYOUT

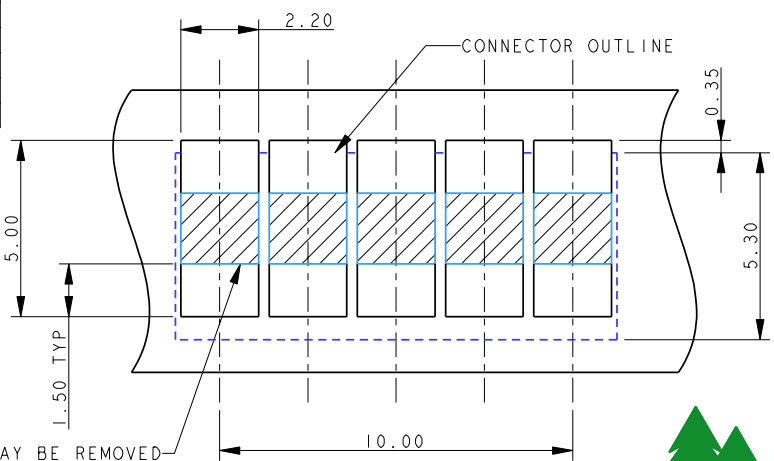

PAD AREA MAY BE REMOVED
 AT CUSTOMER DISCRETION

- NOTES
- FOR FULL PRODUCT SPECIFICATION REFER TO ELCO SPECIFICATION 201-01-093
 - CRITICAL DIMENSIONS SHOWN AS :- ▲
 - GENERAL TOLERANCE ±0.2



ELCO EUROPE (A DIVISION OF AVX LTD.) CONFIDENTIAL PROPRIETARY
 THE DRAWING ON THIS PRINT AND INFORMATION THEREWITH ARE
 PROPRIETARY TO ELCO EUROPE (A DIVISION OF AVX LTD.) AND
 SHALL NOT BE USED OR DISCUSSED IN WHOLE OR IN PART
 WITHOUT ELCO EUROPE'S WRITTEN CONSENT.

Release No.
 History
 101634

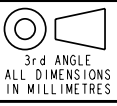

ELCO
 © COPYRIGHT ELCO EUROPE
 NOT TO BE DISCLOSED OR COPIED
 WITHOUT WRITTEN PERMISSION

Drawn
 JDN
 Size
 CV

Description
 OUTLINE DRAWING
 Part Number
 00-9155-01_200S

DATE
 16-Sept-04
 Issue
 C