

### FEATURES

- Tri-axis gyroscope with digital range scaling**
  - ±75°/s, ±150°/s, ±300°/s settings
  - 14-bit resolution
- Tri-axis accelerometer**
  - ±10 g measurement range
  - 14-bit resolution
- 350 Hz bandwidth**
- Factory calibrated sensitivity, bias, and alignment**
  - ADIS16350: +25°C
  - ADIS16355: -40°C to +85°C
- Digitally controlled bias calibration**
- Digitally controlled sample rate**
- Digitally controlled filtering**
- Programmable condition monitoring**
- Auxiliary digital input/output**
- Digitally activated self-test**
- Programmable power management**
- Embedded temperature sensor**
- SPI-compatible serial interface**
- Auxiliary 12-bit ADC input and DAC output**
- Single-supply operation: 4.75 V to 5.25 V**
- 2000 g shock survivability**

### APPLICATIONS

- Guidance and control
- Platform control and stabilization
- Motion control and analysis
- Inertial measurement units
- General navigation
- Image stabilization
- Robotics

### GENERAL DESCRIPTION

The ADIS16350/ADIS16355 *iSensor™* is a complete triple axis gyroscope and triple axis accelerometer inertial sensing system. This sensor combines the Analog Devices, Inc., *iMEMS®* and mixed signal processing technology to produce a highly integrated solution that provides calibrated, digital inertial sensing. An SPI interface and simple output register structure allow for easy access to data and configuration controls.

The SPI port provides access to the following embedded sensors: X-, Y-, and Z-axis angular rates; X-, Y-, and Z-axis linear acceleration; internal temperature; power supply; and auxiliary analog input. The inertial sensors are precision-aligned across axes, and are calibrated for offset and sensitivity. An embedded

#### Rev. A

Information furnished by Analog Devices is believed to be accurate and reliable. However, no responsibility is assumed by Analog Devices for its use, nor for any infringements of patents or other rights of third parties that may result from its use. Specifications subject to change without notice. No license is granted by implication or otherwise under any patent or patent rights of Analog Devices. Trademarks and registered trademarks are the property of their respective owners.

### FUNCTIONAL BLOCK DIAGRAM

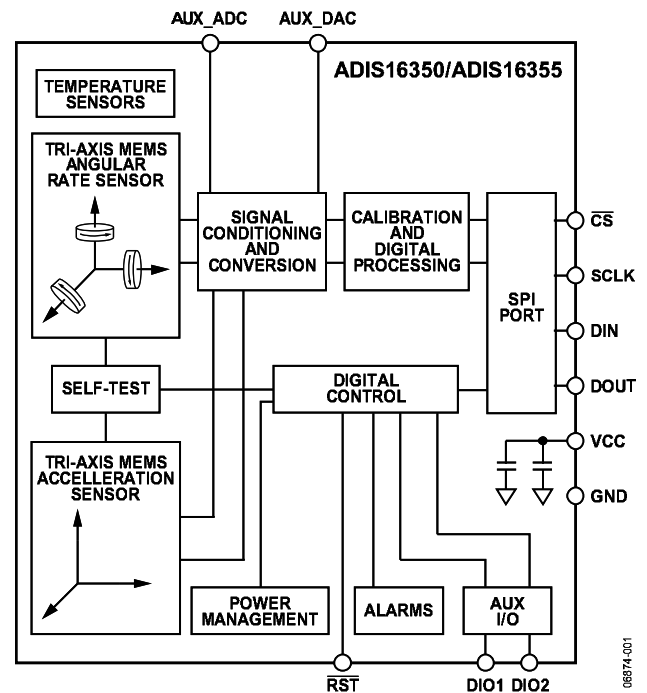

Figure 1.

controller dynamically compensates for all major influences on the MEMS sensors, thus maintaining highly accurate sensor outputs without further testing, circuitry, or user intervention.

The following programmable features simplify system integration: in-system autobias calibration, digital filtering and sample rate, self-test, power management, condition monitoring, and auxiliary digital input/output.

This compact module is approximately 23 mm × 23 mm × 23 mm and provides a convenient flex-based connector system.

## TABLE OF CONTENTS

|  |    |  |    |
|--|----|--|----|
| Features .....                                   | 1  | Control Register Structure .....       | 12 |
| Applications.....                                | 1  | Auxiliary ADC Function.....            | 12 |
| Functional Block Diagram .....                   | 1  | Basic Operation .....                  | 13 |
| General Description .....                        | 1  | Serial Peripheral Interface (SPI)..... | 13 |
| Revision History .....                           | 2  | Data Output Register Access .....      | 14 |
| Specifications.....                              | 3  | Programming and Control.....           | 15 |
| Timing Specifications .....                      | 6  | Control Register Overview .....        | 15 |
| Timing Diagrams.....                             | 6  | Control Register Structure .....       | 15 |
| Absolute Maximum Ratings.....                    | 7  | Calibration.....                       | 16 |
| ESD Caution.....                                 | 7  | Global Commands .....                  | 16 |
| Pin Configuration and Function Descriptions..... | 8  | Operational Control.....               | 17 |
| Typical Performance Characteristics .....        | 9  | Status and Diagnostics.....            | 19 |
| Theory of Operation .....                        | 12 | Applications Information .....         | 22 |
| Overview.....                                    | 12 | Installation Guidelines.....           | 22 |
| Gyroscope Sensor.....                            | 12 | Outline Dimensions.....                | 24 |
| Accelerometer Sensor .....                       | 12 | Ordering Guide .....                   | 24 |
| Factory Calibration .....                        | 12 |  |    |

## REVISION HISTORY

### 2/08—Rev. 0 to Rev. A

|   |           |
|---|-----------|
| Added ADIS16355.....  | Universal |
| Changes to Features.....  | 1         |
| Changes to General Description .....  | 1         |
| Changes to Temperature Coefficient Throughout Table 1 and Gyroscope Noise Performance Output Noise..... | 3         |
| Changes to Output Range.....  | 4         |
| Added Endnote 1 .....   | 5         |
| Changes to Table 3.....   | 7         |
| Inserted Figure 4.....  | 8         |
| Deleted Figure 10.....  | 8         |
| Inserted Figure 9, Figure 10, and Figure 11 .....   | 9         |
| Deleted Figure 12.....  | 9         |
| Changes to Figure 13 and Figure 14.....   | 10        |
| Inserted Figure 15.....   | 10        |
| Deleted Figure 17, Figure 18, Figure 20, and Figure 21.....   | 10        |

|   |    |
|---|----|
| Changes to Factory Calibration Section.....           | 12 |
| Changes to Writing to Registers Section .....         | 13 |
| Replaced Data Output Register Access Section .....    | 14 |
| Deleted Figure 28.....                                | 15 |
| Changes to Table 9.....                               | 15 |
| Changes to Global Commands Section.....               | 16 |
| Changes to Internal Sample Rate Section .....         | 17 |
| Changes to Auxiliary DAC Section.....                 | 18 |
| Changes to General-Purpose Input/Output Section ..... | 18 |
| Changes to Table 37 .....                             | 21 |
| Changes to Installation Guidelines Section .....      | 22 |
| Updated Outline Dimensions.....                       | 24 |
| Changes to Ordering Guide .....                       | 24 |

### 8/07—Revision 0: Initial Version

## SPECIFICATIONS

T<sub>A</sub> = -40°C to +85°C, V<sub>CC</sub> = 5.0 V, angular rate = 0°/s, dynamic range = 300°/s, ±1 g unless otherwise noted.

Table 1.

| Parameter                       | Conditions   | Min    | Typ     | Max    | Unit        |
|---------------------------------|--|--------|---------|--------|-------------|
| GYROSCOPE SENSITIVITY           | Each axis  |        |         |        |             |
| Initial Sensitivity             | 25°C, dynamic range = ±300°/s  | 0.0725 | 0.07326 | 0.0740 | °/s/LSB     |
|                                 | 25°C, dynamic range = ±150°/s  |        | 0.03663 |        | °/s/LSB     |
|                                 | 25°C, dynamic range = ±75°/s   |        | 0.01832 |        | °/s/LSB     |
| Temperature Coefficient         | ADIS16350, see Figure 6  |        | 600     |        | ppm/°C      |
|                                 | ADIS16355, see Figure 9  |        | 40      |        | ppm/°C      |
| Gyroscope Axis Nonorthogonality | 25°C, difference from 90° ideal                                      |        | ±0.05   |        | Degree      |
| Gyroscope Axis Misalignment     | 25°C, relative to base-plate and guide pins                          |        | ±0.5    |        | Degree      |
| Nonlinearity                    | Best fit straight line   |        | 0.1     |        | % of FS     |
| GYROSCOPE BIAS                  |  |        |         |        |             |
| In Run Bias Stability           | 25°C, 1 $\sigma$   |        | 0.015   |        | °/s         |
| Angular Random Walk             | 25°C   |        | 4.2     |        | °/√hr       |
| Temperature Coefficient         | ADIS16350, see Figure 7  |        | 0.1     |        | °/s/°C      |
|                                 | ADIS16355, see Figure 10   |        | 0.01    |        | °/s/°C      |
| Linear Acceleration Effect      | Any axis, 1 $\sigma$ (linear acceleration bias compensation enabled) |        | 0.05    |        | °/s/g       |
| Voltage Sensitivity             | V <sub>CC</sub> = 4.75 V to 5.25 V                                   |        | 0.25    |        | °/s/V       |
| GYROSCOPE NOISE PERFORMANCE     |  |        |         |        |             |
| Output Noise                    | 25°C, ±300°/s range, 2-tap filter setting                            |        | 0.60    |        | °/s rms     |
|                                 | 25°C, ±150°/s range, 8-tap filter setting                            |        | 0.35    |        | °/s rms     |
|                                 | 25°C, ±75°/s range, 32-tap filter setting                            |        | 0.17    |        | °/s rms     |
| Rate Noise Density              | 25°C, f = 25 Hz, ±300°/s, no filtering                               |        | 0.05    |        | °/s/√Hz rms |
| GYROSCOPE FREQUENCY RESPONSE    |  |        |         |        |             |
| 3 dB Bandwidth                  |  |        | 350     |        | Hz          |
| Sensor Resonant Frequency       |  |        | 14      |        | kHz         |
| GYROSCOPE SELF-TEST STATE       |  |        |         |        |             |
| Change for Positive Stimulus    | ±300°/s range setting  | 432    | 723     | 1105   | LSB         |
| Change for Negative Stimulus    | ±300°/s range setting  | -432   | -723    | -1105  | LSB         |
| Internal Self-Test Cycle Time   |  |        | 25      |        | ms          |
| ACCELEROMETER SENSITIVITY       | Each axis  |        |         |        |             |
| Dynamic Range                   |  | ±8     | ±10     |        | g           |
| Initial Sensitivity             | 25°C   | 2.471  | 2.522   | 2.572  | mg/LSB      |
| Temperature Coefficient         | ADIS16350, see Figure 8  |        | 100     |        | ppm/°C      |
|                                 | ADIS16355, see Figure 11   |        | 40      |        | ppm/°C      |
| Axis Nonorthogonality           | 25°C, difference from 90° ideal                                      |        | ±0.25   |        | Degree      |
| Axis Misalignment               | 25°C, relative to base-plate and guide pins                          |        | ±0.5    |        | Degree      |
| Nonlinearity                    | Best fit straight line   |        | ±0.2    |        | % of FS     |
| ACCELEROMETER BIAS              |  |        |         |        |             |
| In-Run Bias Stability           | 25°C, 1 $\sigma$   |        | 0.7     |        | mg          |
| Velocity Random Walk            | 25°C   |        | 2.0     |        | m/s/√hr     |
| Temperature Coefficient         | ADIS16350, see Figure 12   |        | 4       |        | mg/°C       |
|                                 | ADIS16355, see Figure 15   |        | 0.5     |        | mg/°C       |

# ADIS16350/ADIS16355

| Parameter                               | Conditions  | Min    | Typ   | Max  | Unit       |
|---|---|--------|-------|------|------------|
| <b>ACCELEROMETER NOISE PERFORMANCE</b>  |   |        |       |      |            |
| Output Noise                            | 25°C, no filtering  |        | 35    |      | mg rms     |
| Noise Density                           | 25°C, no filtering  |        | 1.85  |      | mg/√Hz rms |
| <b>ACCELEROMETER FREQUENCY RESPONSE</b> |   |        |       |      |            |
| 3 dB Bandwidth                          |   |        | 350   |      | Hz         |
| Sensor Resonant Frequency               |   |        | 10    |      | kHz        |
| <b>ACCELEROMETER SELF-TEST STATE</b>    |   |        |       |      |            |
| Output Change When Active               |   | 73     | 146   | 219  | LSB        |
| <b>TEMPERATURE SENSOR</b>               |   |        |       |      |            |
| Output at 25°C                          |   |        | 0     |      | LSB        |
| Scale Factor                            |   |        | 6.88  |      | LSB/°C     |
| <b>ADC INPUT</b>                        |   |        |       |      |            |
| Resolution                              |   |        | 12    |      | Bits       |
| Integral Nonlinearity                   |   |        | ±2    |      | LSB        |
| Differential Nonlinearity               |   |        | ±1    |      | LSB        |
| Offset Error                            |   |        | ±4    |      | LSB        |
| Gain Error                              |   |        | ±2    |      | LSB        |
| Input Range                             |   | 0      |       | 2.5  | V          |
| Input Capacitance                       | During acquisition  |        | 20    |      | pF         |
| <b>DAC OUTPUT</b>                       |   |        |       |      |            |
| Resolution                              | 5 kΩ/100 pF to GND  |        | 12    |      | Bits       |
| Relative Accuracy                       | For Code 101 to Code 4095                                       |        | ±4    |      | LSB        |
| Differential Nonlinearity               |   |        | ±1    |      | LSB        |
| Offset Error                            |   |        | ±5    |      | mV         |
| Gain Error                              |   |        | ±0.5  |      | %          |
| Output Range                            |   |        |       | 2.5  | V          |
| Output Impedance                        |   |        | 2     |      | Ω          |
| Output Settling Time                    |   |        | 10    |      | μs         |
| <b>LOGIC INPUTS<sup>1</sup></b>         |   |        |       |      |            |
| Input High Voltage, V <sub>INH</sub>    |   | 2.0    |       |      | V          |
| Input Low Voltage, V <sub>INL</sub>     |   |        |       | 0.8  | V          |
|   | For $\overline{CS}$ signal when used to wake up from sleep mode |        |       | 0.55 | V          |
| Logic 1 Input Current, I <sub>INH</sub> | V <sub>IH</sub> = 3.3 V   |        | ±0.2  | ±10  | μA         |
| Logic 0 Input Current, I <sub>INL</sub> | V <sub>IL</sub> = 0 V   |        |       |      | μA         |
| All Except $\overline{RST}$             |   |        | -40   | -60  | μA         |
| $\overline{RST}$                        |   |        | -1    |      | mA         |
| Input Capacitance, C <sub>IN</sub>      |   |        | 10    |      | pF         |
| <b>DIGITAL OUTPUTS<sup>1</sup></b>      |   |        |       |      |            |
| Output High Voltage, V <sub>OH</sub>    | I <sub>SOURCE</sub> = 1.6 mA                                    | 2.4    |       |      | V          |
| Output Low Voltage, V <sub>OL</sub>     | I <sub>SINK</sub> = 1.6 mA                                      |        |       | 0.4  | V          |
| <b>SLEEP TIMER</b>                      |   |        |       |      |            |
| Timeout Period <sup>2</sup>             |   | 0.5    |       | 128  | Sec        |
| <b>FLASH MEMORY</b>                     |   |        |       |      |            |
| Endurance <sup>3</sup>                  |   | 10,000 |       |      | Cycles     |
| Data Retention <sup>4</sup>             | T <sub>J</sub> = 85°C   | 20     |       |      | Years      |
| <b>CONVERSION RATE</b>                  |   |        |       |      |            |
| Maximum Sample Rate                     | SMPL_PRD = 0x01   |        | 819.2 |      | SPS        |
| Minimum Sample Rate                     | SMPL_PRD = 0xFF   |        | 0.413 |      | SPS        |

# ADIS16350/ADIS16355

| Parameter                         | Conditions          | Min  | Typ | Max  | Unit |
|-----------------------------------|---------------------|------|-----|------|------|
| START-UP TIME <sup>5</sup>        |                     |      |     |      |      |
| Initial Power-Up                  |                     |      | 150 |      | ms   |
| Sleep Mode Recovery               |                     |      | 3   |      | ms   |
| POWER SUPPLY                      |                     |      |     |      |      |
| Operating Voltage Range, $V_{CC}$ |                     | 4.75 | 5.0 | 5.25 | V    |
| Power Supply Current              | Normal mode at 25°C |      | 33  |      | mA   |
|                                   | Fast mode at 25°C   |      | 57  |      | mA   |
|                                   | Sleep mode at 25°C  |      | 500 |      | μA   |

<sup>1</sup> The digital I/O signals are driven by an internal 3.3 V supply, and the inputs are 5 V tolerant.

<sup>2</sup> Guaranteed by design.

<sup>3</sup> Endurance is qualified as per JEDEC Standard 22, Method A117 and measured at -40°C, +25°C, +85°C, and +125°C.

<sup>3</sup> Retention lifetime equivalent at junction temperature (T<sub>J</sub>) 85°C as per JEDEC Standard 22, Method A117. Retention lifetime decreases with junction temperature.

<sup>5</sup> Defined as the time from wake-up to the first conversion. This time does not include sensor settling time, which is dependent on the filter settings.

# ADIS16350/ADIS16355

## TIMING SPECIFICATIONS

$T_A = 25^\circ\text{C}$ ,  $V_{CC} = 5.0\text{ V}$ , angular rate =  $0^\circ/\text{s}$ , unless otherwise noted.

Table 2.

| Parameter                  | Description  | Min <sup>1</sup> | Typ | Max <sup>1</sup> | Unit          |
|----------------------------|--|------------------|-----|------------------|---------------|
| $f_{\text{SCLK}}$          | Fast mode, $\text{SMPL\_PRD} \leq 0x09$ ( $f_s \geq 164\text{ Hz}$ )<br>Normal mode, $\text{SMPL\_PRD} \geq 0x0A$ ( $f_s \leq 149\text{ Hz}$ ) | 0.01             | 2   | 300              | MHz           |
| $t_{\text{DARATE}}$        | Data rate time, fast mode, $\text{SMPL\_PRD} \leq 0x09$ ( $f_s \geq 164\text{ Hz}$ )   | 40               |     |                  | $\mu\text{s}$ |
|                            | Data rate time, normal mode, $\text{SMPL\_PRD} \geq 0x0A$ ( $f_s \leq 149\text{ Hz}$ )   | 160              |     |                  | $\mu\text{s}$ |
| $t_{\text{DATASTALL}}$     | Data stall time, fast mode $\text{SMPL\_PRD} \leq 0x09$ ( $f_s \geq 164\text{ Hz}$ )   | 9                |     |                  | $\mu\text{s}$ |
|                            | Data stall time, normal mode $\text{SMPL\_PRD} \geq 0x0A$ ( $f_s \leq 149\text{ Hz}$ )   | 75               |     |                  | $\mu\text{s}$ |
| $t_{\overline{\text{CS}}}$ | Chip select to clock edge  | 48.8             |     |                  | ns            |
| $t_{\text{DAV}}$           | Data output valid after SCLK falling edge <sup>2</sup>   |                  |     | 100              | ns            |
| $t_{\text{DSU}}$           | Data input setup time before SCLK rising edge  | 24.4             |     |                  | ns            |
| $t_{\text{DHD}}$           | Data input hold time after SCLK rising edge  | 48.8             |     |                  | ns            |
| $t_{\text{DF}}$            | Data output fall time  |                  | 5   | 12.5             | ns            |
| $t_{\text{DR}}$            | Data output rise time  |                  | 5   | 12.5             | ns            |
| $t_{\text{SFS}}$           | $\overline{\text{CS}}$ high after SCLK edge <sup>3</sup>   | 5                |     |                  | ns            |

<sup>1</sup> Guaranteed by design, not production tested.

<sup>2</sup> The MSB presents an exception to this parameter. The MSB clocks out on the falling edge of  $\overline{\text{CS}}$ . The rest of the DOUT bits are clocked after the falling edge of SCLK and are governed by this specification.

<sup>3</sup> This parameter may need to be expanded to allow for proper capture of the LSB. After  $\overline{\text{CS}}$  goes high, the DOUT line goes into a high impedance state.

## TIMING DIAGRAMS

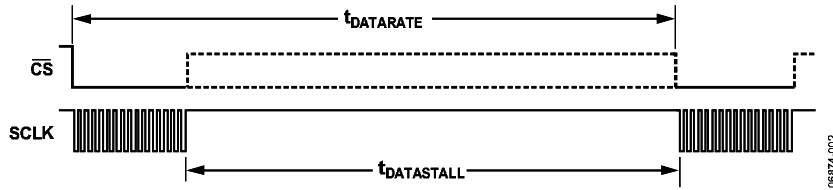

Figure 2. SPI Chip Select Timing

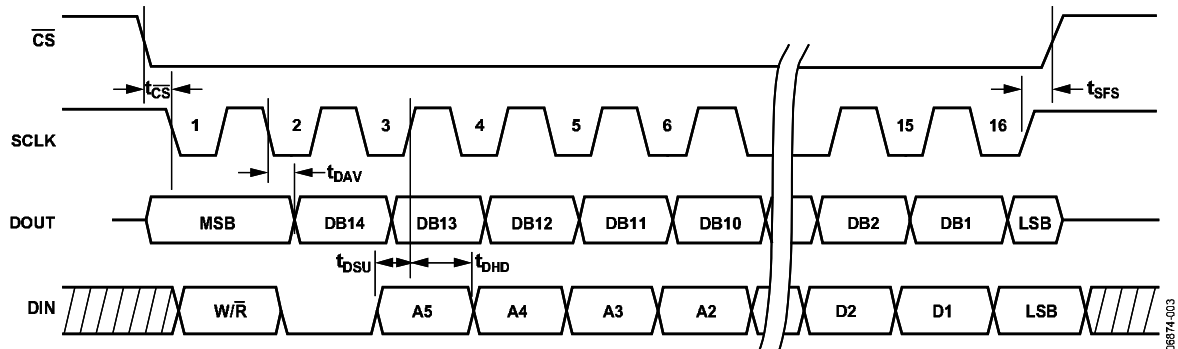

Figure 3. SPI Timing, Utilizing SPI Settings Typically Identified as Phase = 1, Polarity = 1

## ABSOLUTE MAXIMUM RATINGS

Table 3.

| Parameter                           | Rating                         |
|-------------------------------------|--------------------------------|
| Acceleration                        |                                |
| Any Axis, Unpowered                 | 2000 <i>g</i>                  |
| Any Axis, Powered                   | 2000 <i>g</i>                  |
| VCC to GND                          | −0.3 V to +6.0 V               |
| Digital Input/Output Voltage to GND | −0.3 V to +5.3 V               |
| Analog Inputs to GND                | −0.3 V to +3.6 V               |
| Operating Temperature Range         | −40°C to +85°C                 |
| Storage Temperature Range           | −65°C to +125°C <sup>1,2</sup> |

<sup>1</sup> Extended exposure to temperatures outside the specified temperature range of −40°C to +85°C can adversely affect the accuracy of the factory calibration. For best accuracy, store the parts within the specified operating range of −40°C to +85°C.

<sup>2</sup> Although the device is capable of withstanding short-term exposure to 150°C, long-term exposure threatens internal mechanical integrity.

Stresses above those listed under Absolute Maximum Ratings may cause permanent damage to the device. This is a stress rating only; functional operation of the device at these or any other conditions above those indicated in the operational section of this specification is not implied. Exposure to absolute maximum rating conditions for extended periods may affect device reliability.

Table 4. Package Characteristics

| Package Type   | $\theta_{JA}$ | $\theta_{JC}$ | Device Weight |
|----------------|---------------|---------------|---------------|
| 24-Lead Module | 39.8°C/W      | 14.2°C/W      | 16 grams      |

### ESD CAUTION



**ESD (electrostatic discharge) sensitive device.** Charged devices and circuit boards can discharge without detection. Although this product features patented or proprietary protection circuitry, damage may occur on devices subjected to high energy ESD. Therefore, proper ESD precautions should be taken to avoid performance degradation or loss of functionality.

# ADIS16350/ADIS16355

## PIN CONFIGURATION AND FUNCTION DESCRIPTIONS

ADIS16350/ADIS16355  
TOP VIEW  
(Not to Scale)

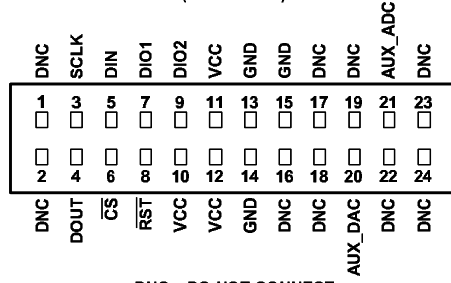

DNC = DO NOT CONNECT

**NOTES**

1. CONNECTOR PINS ARE NOT VISIBLE FROM THE TOP VIEW.
2. THIS REPRESENTATION DISPLAYS THE TOP VIEW PINOUT FOR THE MATING SOCKET CONNECTOR.
3. DNC = DO NOT CONNECT.

Figure 4. Pin Configuration

Table 5. Pin Function Descriptions

| Pin No.                          | Mnemonic         | Type <sup>1</sup> | Description                   |
|----------------------------------|------------------|-------------------|-------------------------------|
| 1, 2, 16, 17, 18, 19, 22, 23, 24 | DNC              | N/A               | Do Not Connect                |
| 3                                | SCLK             | I                 | SPI Serial Clock              |
| 4                                | DOUT             | O                 | SPI Data Output               |
| 5                                | DIN              | I                 | SPI Data Input                |
| 6                                | $\overline{CS}$  | I                 | SPI Chip Select               |
| 7                                | DIO1             | I/O               | Digital Input/Output          |
| 8                                | $\overline{RST}$ | I                 | Reset                         |
| 9                                | DIO2             | I/O               | Digital Input/Output          |
| 10, 11, 12                       | VCC              | S                 | Power Supply                  |
| 13, 14, 15                       | GND              | S                 | Power Ground                  |
| 20                               | AUX_DAC          | O                 | Auxiliary, 12-Bit, DAC Output |
| 21                               | AUX_ADC          | I                 | Auxiliary, 12-Bit, ADC Input  |

<sup>1</sup>S = supply, O = output, I = input.

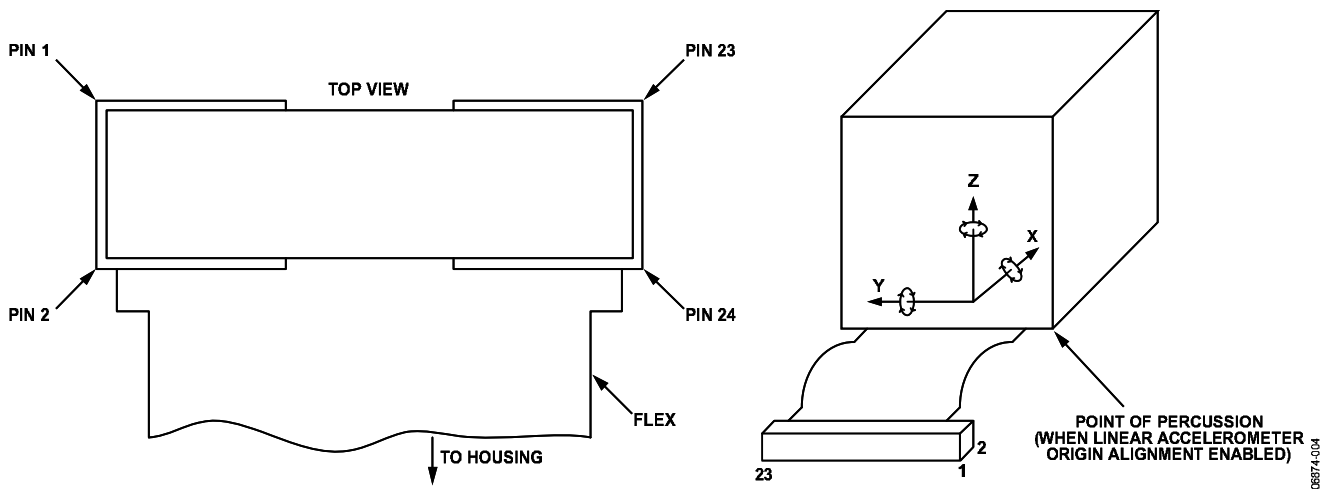

Figure 5. Pin Configuration, Connector Top View



TYPICAL PERFORMANCE CHARACTERISTICS

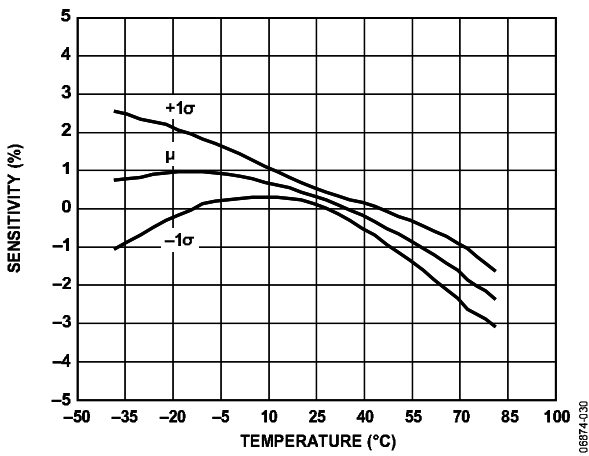

Figure 6. ADIS16350 Gyroscope Sensitivity vs. Temperature

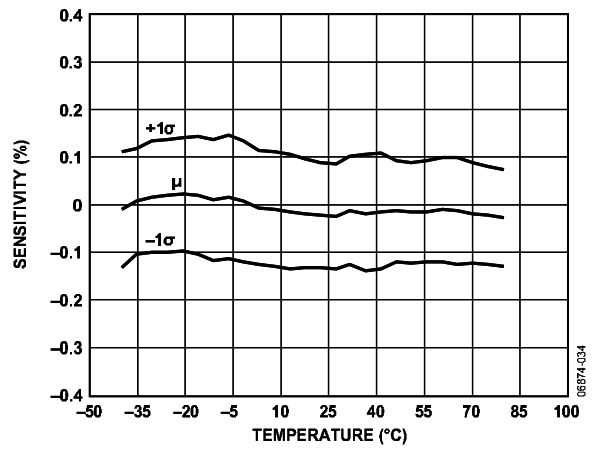

Figure 9. ADIS16355 Gyroscope Sensitivity vs. Temperature

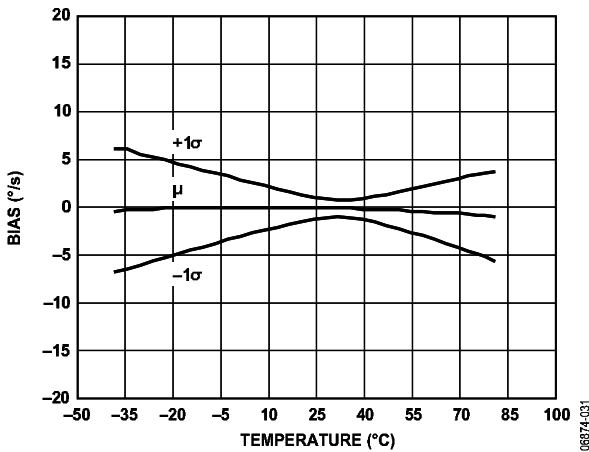

Figure 7. ADIS16350 Gyroscope Bias vs. Temperature

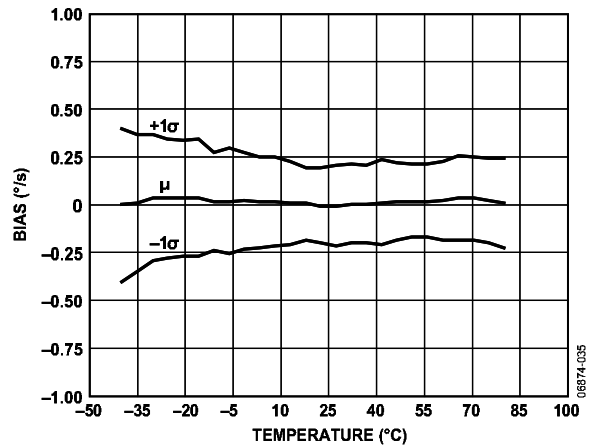

Figure 10. ADIS16355 Gyroscope Bias vs. Temperature

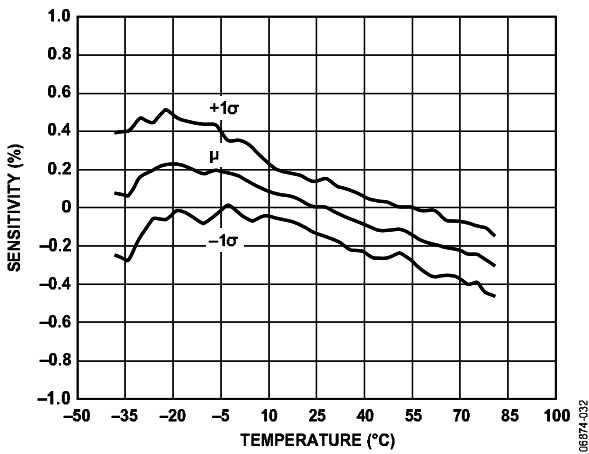

Figure 8. ADIS16350 Accelerometer Sensitivity vs. Temperature

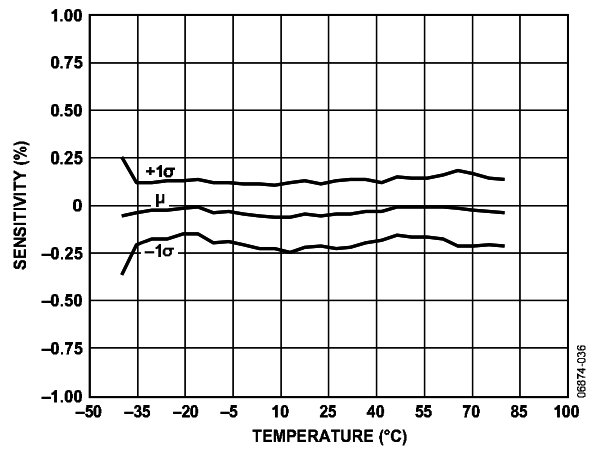

Figure 11. ADIS16355 Accelerometer Sensitivity vs. Temperature

# ADIS16350/ADIS16355

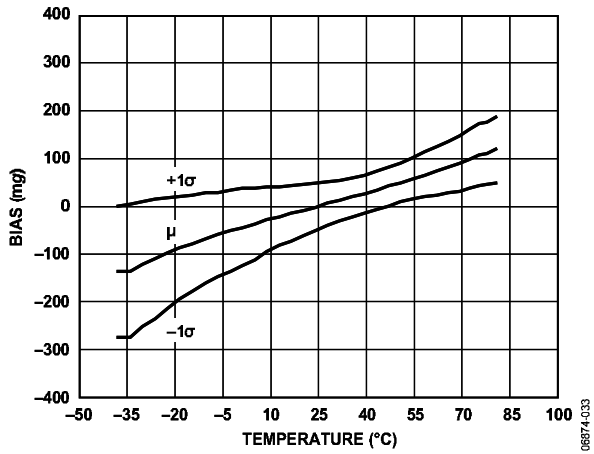

Figure 12. ADIS16350 Accelerometer Bias vs. Temperature

06B74-030

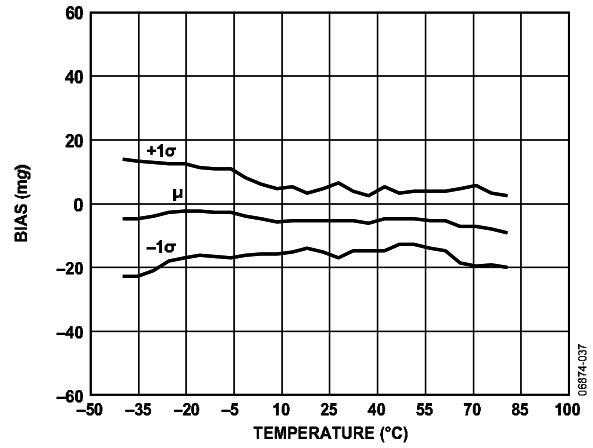

Figure 15. ADIS16355 Accelerometer Bias vs. Temperature

06B74-037

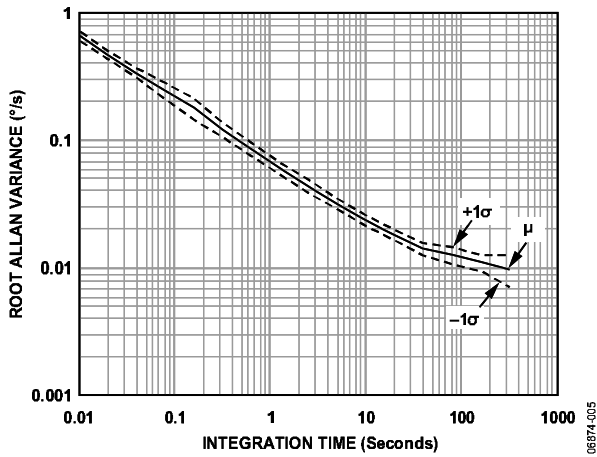

Figure 13. Gyroscope Root Allan Variance

06B74-005

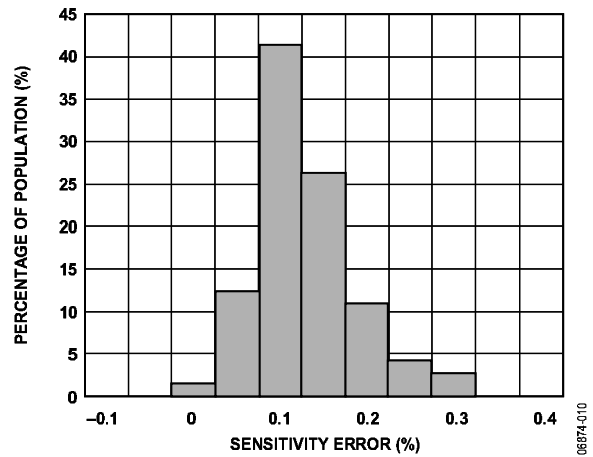

Figure 16. Gyroscope Sensitivity Error, +25°C

06B74-010

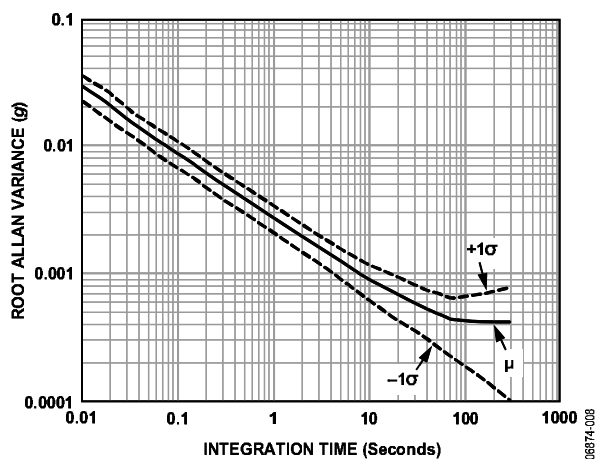

Figure 14. Accelerometer Root Allan Variance

06B74-008

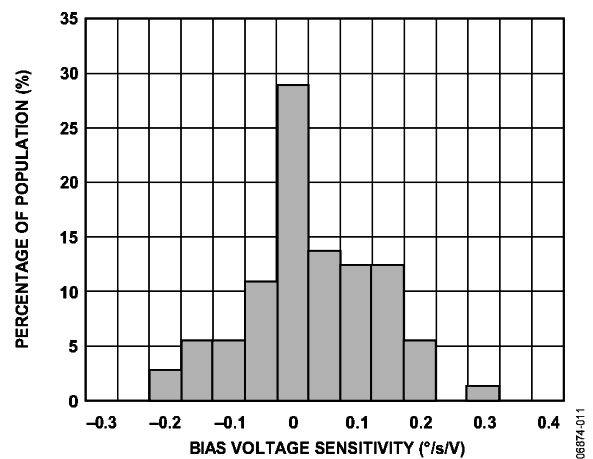

Figure 17. Gyroscope Bias Voltage Power Supply Sensitivity, +25°C

06B74-011

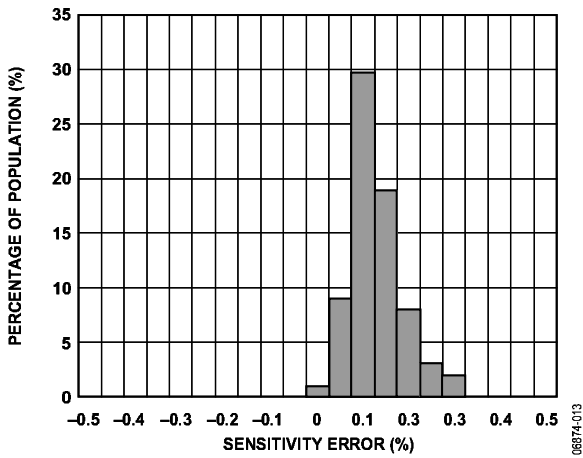

Figure 18. Accelerometer Sensitivity Error Distribution, +25°C

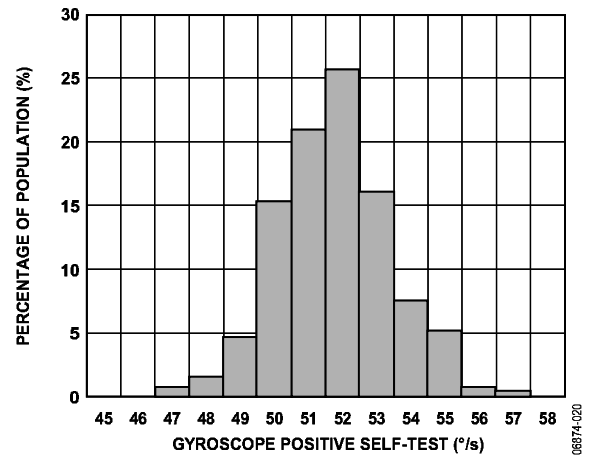

Figure 21. Gyroscope Positive Self-Test Distribution, +25°C

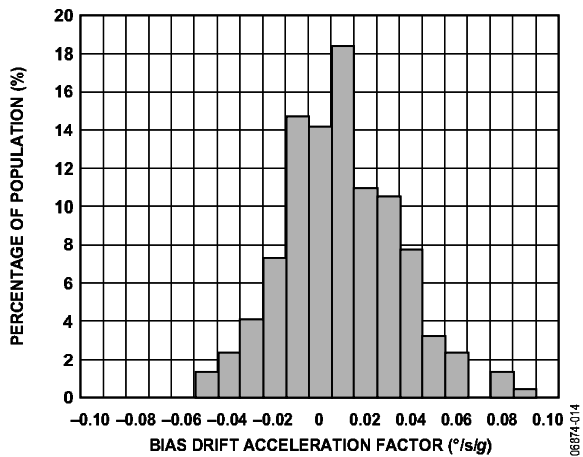

Figure 19. Gyroscope Bias Sensitivity to Linear Acceleration, +25°C

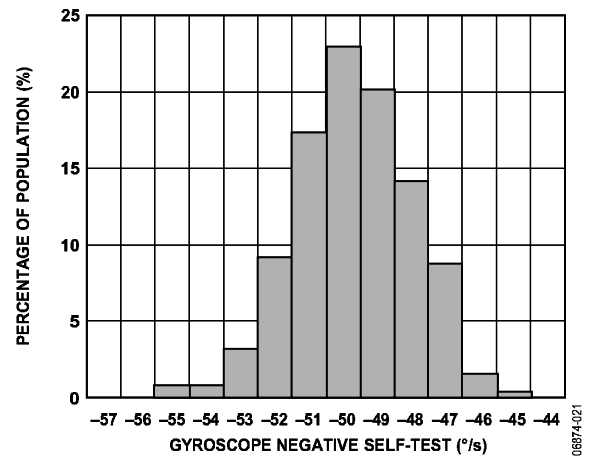

Figure 22. Gyroscope Negative Self-Test Distribution, +25°C

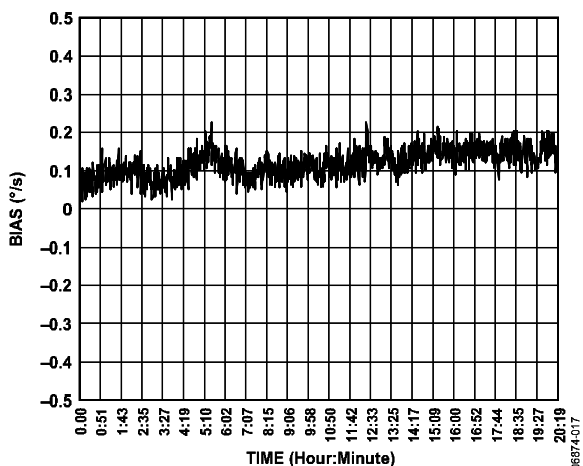

Figure 20. Long-Term Bias Stability, +25°C

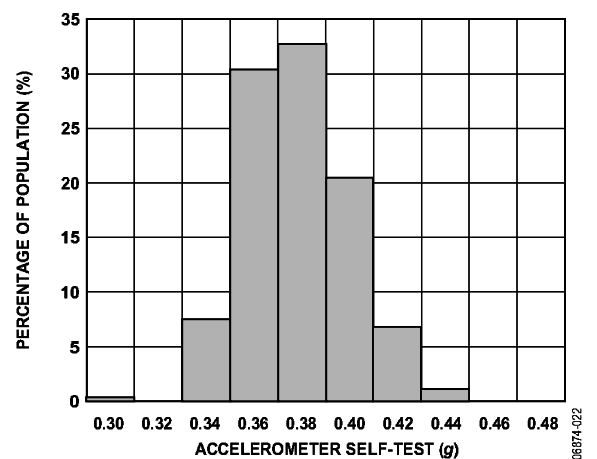

Figure 23. Accelerometer Self-Test Distribution, +25°C

# ADIS16350/ADIS16355

## THEORY OF OPERATION

### OVERVIEW

The ADIS16350/ADIS16355 integrate three orthogonal axes of gyroscope sensors with three orthogonal axes of accelerometer sensors, creating the basic six degrees of freedom (6DOF) in a single package. The accelerometers are oriented along the axis of rotation for each gyroscope. These six sensing elements are held together by a mechanical structure that provides tight force and motion coupling. Each sensor output signal is sampled using an ADC, and then the digital data is fed into a proprietary digital processing circuit. The digital processing circuit applies the correction tables to each sensor output, manages the input/output function using a simple register structure and serial interface, and provides many other features that simplify system-level designs.

### GYROSCOPE SENSOR

The core MEMs angular rate sensor (gyroscope) operates on the principle of a resonator gyroscope. Two polysilicon sensing structures each contain a dither frame, which is electrostatically driven to resonance. This provides the velocity element required to produce a Coriolis force during rotation. At two of the outer extremes of each frame, orthogonal to the dither motion, are movable fingers that are placed between fixed fingers to form a capacitive pickoff structure that senses Coriolis motion. The resulting signal is fed to a series of gain and demodulation stages that produce the electrical rate signal output.

### ACCELEROMETER SENSOR

The core acceleration sensor is a surface micromachined polysilicon structure built on top of the silicon wafer. Polysilicon springs suspend the structure over the surface of the wafer and provide a resistance against acceleration forces. Deflection of the structure is measured using a differential capacitor that consists of independent fixed plates and central plates attached to the moving mass. Acceleration deflects the beam and unbalances the differential capacitor, resulting in a differential output that is fed to a series of gain and demodulation stages that produce the electrical rate signal output.

### FACTORY CALIBRATION

The ADIS16350 provides a factory calibration that simplifies the process of integrating it into system-level designs. This calibration provides correction for initial sensor bias and sensitivity, power supply variation, axial alignment, and linear acceleration (gyroscopes). An extensive, three-dimensional characterization provides the basis for generating correction tables for each individual sensor. The ADIS16355 provides the same calibration, over temperature.

### CONTROL REGISTER STRUCTURE

The ADIS16350/ADIS16355 provide configuration control to many critical operating parameters by using a dual-memory register structure. The volatile SRAM register locations control operation of the part while the nonvolatile flash memory locations preserve the configuration settings. Updating register contents affects only its SRAM location. Preserving the updates in its corresponding flash memory location requires initiation of the flash update command. This helps reduce the number of write cycles to the flash memory and consequently increases the endurance of the flash memory. During startup and reset-recovery sequences, the flash memory contents are automatically loaded into the SRAM register locations.

### AUXILIARY ADC FUNCTION

The auxiliary ADC is a standard 12-bit ADC that digitizes other system-level analog signals. The output of the ADC can be monitored through the AUX\_ADC register, as defined in Table 6. The ADC is a 12-bit successive approximation converter. The output data is presented in straight binary format with the full-scale range extending from 0 V to 2.5 V.

Figure 24 shows the equivalent circuit of the analog input structure of the ADC. The input capacitor (C1) is typically 4 pF and can be attributed to parasitic package capacitance. The two diodes provide ESD protection for the analog input. Care must be taken to ensure that the analog input signals are never outside the range of  $-0.3$  V to  $+3.5$  V. Signals outside this range causes the diodes to become forward-biased and to start conducting. The diodes can handle 10 mA without causing irreversible damage. The resistor is a lumped component that represents the on resistance of the switches. The value of this resistance is typically 100  $\Omega$ . Capacitor C2 represents the ADC sampling capacitor and is typically 16 pF.

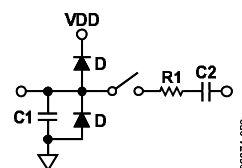

Figure 24. Equivalent Analog Input Circuit  
Conversion Phase: Switch Open  
Track Phase: Switch Closed

For ac applications, it is recommended that high frequency components from the analog input signal be removed by using a low-pass filter on the analog input pin.

In applications where harmonic distortion and signal-to-noise ratios are critical, the analog input must be driven from a low impedance source. Large source impedances significantly affect the ac performance of the ADC. This can necessitate the use of an input buffer amplifier. When no input amplifier is used to drive the analog input, the source impedance should be limited to values lower than 1 k $\Omega$ .

## BASIC OPERATION

The ADIS16350/ADIS16355 are designed for simple integration into system designs, requiring only a 5 V power supply and a 4-wire, industry-standard serial peripheral interface (SPI). All outputs and user-programmable functions are handled by a simple register structure. Each register is 16 bits in length and has its own unique bit map. The 16 bits in each register consist of an upper byte (D8 to D15) and a lower byte (D0 to D7), each with its own 6-bit address.

### SERIAL PERIPHERAL INTERFACE (SPI)

The serial peripheral interface (SPI) port includes four signals: chip select ( $\overline{CS}$ ), serial clock (SCLK), data input (DIN), and data output (DOUT). The  $\overline{CS}$  line enables the SPI port and frames each SPI event. When this signal is high, the DOUT line is in a high impedance state and the signals on DIN and SCLK have no impact on operation. A complete data frame contains 16 clock cycles. Because the SPI port operates in full-duplex mode, it supports simultaneous, 16-bit receive (DIN) and transmit (DOUT) functions during the same data frame. This enables the user to configure the next read cycle, while, at the same time, receiving the data associated with the previous configuration.

Refer to Table 2, Figure 2, and Figure 3 for detailed information regarding timing and operation of the SPI port.

### Writing to Registers

Figure 25 displays a typical data frame for writing a command to a control register. In this case, the first bit of the DIN sequence is a 1, followed by a 0, the 6-bit address of the target register, and the 8-bit data command. Because each write command covers a single byte of data, two data frames are required when writing the entire 16-bit space of a register. Note that 16 SCLK cycles are required for a successful write operation.

### Reading from Registers

Reading the contents of a register requires a modification to the sequence illustrated in Figure 25. In this case, the first two bits in the DIN sequence are 0, followed by the address of the register. Each register has two addresses (an upper address and a lower address), but either one can be used to access the entire 16 bits of data. The final eight bits of the DIN sequence are irrelevant and can be counted as don't cares during a read command. During the next data frame, the DOUT sequence contains the 16-bit data of the register, as shown in Figure 26. Although a single read command requires two separate data frames, the full-duplex mode minimizes this overhead, requiring only one extra data frame when continuously sampling.

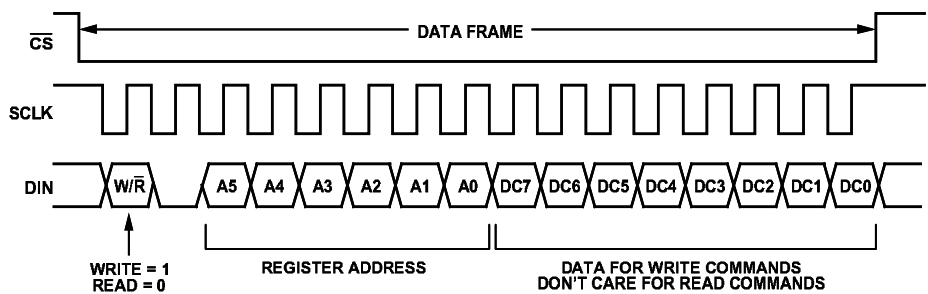

Figure 25. DIN Bit Sequence

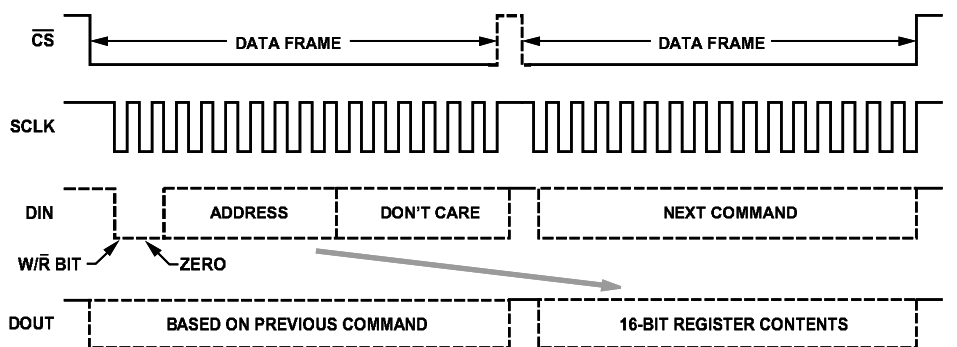

Figure 26. SPI Sequence for Read Commands

# ADIS16350/ADIS16355

## DATA OUTPUT REGISTER ACCESS

Table 6 provides the data configuration for each output data register in the ADIS16350/ADIS16355. Starting with the MSB of the upper byte, each output data register has the following bit sequence: new data (ND) flag, error/alarm (EA) flag, followed by 14 data bits. The data bits are LSB-justified and, in the case of the 12-bit data formats, the remaining two bits (Bit 12 and Bit

13) are not used. The ND flag indicates that unread data resides in the output data registers. This flag clears and returns to 0 during an output register read sequence. It returns to 1 after the next internal sample update cycle completes. The EA flag indicates an error condition. The STATUS register contains all of the error flags and provides the ability to investigate root cause.

**Table 6. Output Data Register Information**

| Name       | Function  | Addresses  | Data Length | Data Format     | Scale Factor (per LSB)  |
|------------|---|------------|-------------|-----------------|-------------------------|
| SUPPLY_OUT | Power supply measurement                        | 0x03, 0x02 | 12 bits     | Binary          | 1.8315 mV <sup>1</sup>  |
| XGYRO_OUT  | X-axis gyroscope output measurement             | 0x05, 0x04 | 14 bits     | Twos complement | 0.07326°/s <sup>2</sup> |
| YGYRO_OUT  | Y-axis gyroscope output measurement             | 0x07, 0x06 | 14 bits     | Twos complement | 0.07326°/s <sup>2</sup> |
| ZGYRO_OUT  | Z-axis gyroscope output measurement             | 0x09, 0x08 | 14 bits     | Twos complement | 0.07326°/s <sup>2</sup> |
| XACCL_OUT  | X-axis acceleration output measurement          | 0x0B, 0x0A | 14 bits     | Twos complement | 2.522 mg                |
| YACCL_OUT  | Y-axis acceleration output measurement          | 0x0D, 0x0C | 14 bits     | Twos complement | 2.522 mg                |
| ZACCL_OUT  | Z-axis acceleration output measurement          | 0x0F, 0x0E | 14 bits     | Twos complement | 2.522 mg                |
| XTEMP_OUT  | X-axis gyroscope sensor temperature measurement | 0x11, 0x10 | 12 bits     | Twos complement | 0.1453°C <sup>3</sup>   |
| YTEMP_OUT  | Y-axis gyroscope sensor temperature measurement | 0x13, 0x12 | 12 bits     | Twos complement | 0.1453°C <sup>3</sup>   |
| ZTEMP_OUT  | Z-axis gyroscope sensor temperature measurement | 0x15, 0x14 | 12 bits     | Twos complement | 0.1453°C <sup>3</sup>   |
| AUX_ADC    | Auxiliary analog input data                     | 0x17, 0x16 | 12 bits     | Binary          | 0.6105 mV               |

<sup>1</sup> 5 V = 2730 LSBs (nominal)

<sup>2</sup> Assumes that the scaling is set to 300°/s.

<sup>3</sup> Typical condition, 25°C = 0 LSB.

**Table 7. Output Coding Example, XGYRO\_OUT, YGYRO\_OUT, and ZGYRO\_OUT<sup>1,2</sup>**

| Rate of Rotation |               |              | Binary Output     | Hexadecimal Output | Decimal |
|------------------|---------------|--------------|-------------------|--------------------|---------|
| ±300°/s Range    | ±150°/s Range | ±75°/s Range |                   |                    |         |
| 80°/s            | 40°/s         | 20°/s        | 00 0100 0100 0100 | 0x0444             | 1092    |
| 40°/s            | 20°/s         | 10°/s        | 00 0010 0010 0010 | 0x0222             | 546     |
| 0.07326°/s       | 0.03663°/s    | 0.018315°/s  | 00 0000 0000 0001 | 0x0001             | 1       |
| 0°/s             | 0°/s          | 0°/s         | 00 0000 0000 0000 | 0x0000             | 0       |
| -0.07326°/s      | -0.03663°/s   | -0.018315°/s | 11 1111 1111 1111 | 0x3FFF             | -1      |
| -40°/s           | -20°/s        | -10°/s       | 11 1101 1101 1110 | 0x3DDE             | -546    |
| -80°/s           | -40°/s        | -20°/s       | 11 1011 1011 1100 | 0x3BBC             | -1092   |

<sup>1</sup> The two most significant bits are not included.

<sup>2</sup> Zero offset null performance is assumed.

**Table 8. Output Coding Example, XACCL\_OUT, YACCL\_OUT, and ZACCL\_OUT<sup>1,2</sup>**

| Acceleration (g) | Binary Output     | Hexadecimal Output | Decimal |
|------------------|-------------------|--------------------|---------|
| 2.522            | 00 0011 1110 1000 | 0x03E8             | 1000    |
| 1                | 00 0001 1000 1101 | 0x018D             | 397     |
| 0.002522         | 00 0000 0000 0001 | 0x0001             | 1       |
| 0                | 00 0000 0000 0000 | 0x0000             | 0       |
| -0.002522        | 11 1111 1111 1111 | 0x3FFF             | -1      |
| -1               | 11 1110 0111 0011 | 0x3E73             | -397    |
| -2.522           | 11 1100 0001 1000 | 0x3C18             | -1000   |

<sup>1</sup> The two most significant bits are not included.

<sup>2</sup> Zero offset null performance is assumed.

## PROGRAMMING AND CONTROL

### CONTROL REGISTER OVERVIEW

There are many programmable features that are controlled by writing commands to the appropriate control registers using the SPI. The following sections describe these controls and specify each function, along with the corresponding register configuration. The features available for configuration in this register space are:

- Calibration
- Global commands
- Operational control
  - Sample rate
  - Power management
  - Digital filtering
  - Dynamic range
  - DAC output
  - Digital input/output
- Operational status and diagnostics
  - Self-test
  - Status conditions
  - Alarms

### CONTROL REGISTER STRUCTURE

The ADIS16350/ADIS16355 use a temporary, RAM-based memory structure to facilitate the control registers listed in Table 9. The operational configuration is stored in a flash memory structure that automatically loads into the control registers during the start-up sequence. Each nonvolatile register has a corresponding flash memory location for storing the latest configuration contents. The contents of each nonvolatile register must be stored to flash manually.

Note that the contents of these registers are nonvolatile after they are stored to flash. The flash update command, available in the COMMAND register, provides this function. The ENDURANCE register provides a counter that allows for reliability management against the flash memory write cycle specification.

**Table 9. Control Register Mapping**

| Register Name | Type | Volatility               | Addresses    | Bytes | Function                               | Reference Tables   |
|---------------|------|--------------------------|--------------|-------|--|--------------------|
| ENDURANCE     | R    | Nonvolatile              | 0x00, 0x01   | 2     | Flash memory write count               | Table 29           |
|               | R    | Volatile                 | 0x02 to 0x17 | 22    | Output data                            | Table 6            |
|               |      |                          | 0x18, 0x19   | 2     | Reserved                               |                    |
| XGYRO_OFF     | R/W  | Nonvolatile              | 0x1A, 0x1B   | 2     | X-axis gyroscope bias offset factor    | Table 10, Table 11 |
| YGYRO_OFF     | R/W  | Nonvolatile              | 0x1C, 0x1D   | 2     | Y-axis gyroscope bias offset factor    | Table 10, Table 11 |
| ZGYRO_OFF     | R/W  | Nonvolatile              | 0x1E, 0x1F   | 2     | Z-axis gyroscope bias offset factor    | Table 10, Table 11 |
| XACCL_OFF     | R/W  | Nonvolatile              | 0x20, 0x21   | 2     | X-axis acceleration bias offset factor | Table 12, Table 13 |
| YACCL_OFF     | R/W  | Nonvolatile              | 0x22, 0x23   | 2     | Y-axis acceleration bias offset factor | Table 12, Table 13 |
| ZACCL_OFF     | R/W  | Nonvolatile              | 0x24, 0x25   | 2     | Z-axis acceleration bias offset factor | Table 12, Table 13 |
| ALM_MAG1      | R/W  | Nonvolatile              | 0x26, 0x27   | 2     | Alarm 1 amplitude threshold            | Table 32, Table 33 |
| ALM_MAG2      | R/W  | Nonvolatile              | 0x28, 0x29   | 2     | Alarm 2 amplitude threshold            | Table 32, Table 33 |
| ALM_SMPL1     | R/W  | Nonvolatile              | 0x2A, 0x2B   | 2     | Alarm 1 sample size                    | Table 34, Table 35 |
| ALM_SMPL2     | R/W  | Nonvolatile              | 0x2C, 0x2D   | 2     | Alarm 2 sample size                    | Table 34, Table 35 |
| ALM_CTRL      | R/W  | Nonvolatile              | 0x2E, 0x2F   | 2     | Alarm control                          | Table 36, Table 37 |
| AUX_DAC       | R/W  | Volatile                 | 0x30, 0x31   | 2     | Auxiliary DAC data                     | Table 22, Table 23 |
| GPIO_CTRL     | R/W  | Volatile                 | 0x32, 0x33   | 2     | Auxiliary digital input/output control | Table 24, Table 25 |
| MSC_CTRL      | R/W  | Nonvolatile <sup>1</sup> | 0x34, 0x35   | 2     | Miscellaneous control                  | Table 27, Table 28 |
| SMPL_PRD      | R/W  | Nonvolatile              | 0x36, 0x37   | 2     | Internal sample period (rate) control  | Table 16, Table 17 |
| SENS/AVG      | R/W  | Nonvolatile              | 0x38, 0x39   | 2     | Dynamic range/digital filter control   | Table 20, Table 21 |
| SLP_CNT       | R/W  | Volatile                 | 0x3A, 0x3B   | 2     | Sleep mode control                     | Table 18, Table 19 |
| STATUS        | R    | Volatile                 | 0x3C, 0x3D   | 2     | System status                          | Table 30, Table 31 |
| COMMAND       | W    | N/A                      | 0x3E, 0x3F   | 2     | System command                         | Table 14, Table 15 |

<sup>1</sup> The contents of the lower byte are nonvolatile; the contents of the upper byte are volatile.

# ADIS16350/ADIS16355

## CALIBRATION

For applications that require point-of-use calibration, the bias correction registers provide bias level control for all six sensors. Table 10, Table 11, Table 12, and Table 13 provide the details required for using these registers to calibrate the output bias for each sensor.

**Table 10. Gyroscope Bias Correction Registers**

| Register  | Addresses  | Common Parameters           |
|-----------|------------|-----------------------------|
| XGYRO_OFF | 0x1A, 0x1B | Default value = 0x0000      |
| YGYRO_OFF | 0x1C, 0x1D | Scale = 0.018315°/s per LSB |
| ZGYRO_OFF | 0x1E, 0x1F | Twos complement, read/write |

**Table 11. Gyroscope Bias Correction Register Bits**

| Bits    | Description  |
|---------|--|
| [15:13] | Not used   |
| [12:0]  | Data bits, typical adjustment range = $\pm 75^\circ$ |

**Table 12. Accelerometer Bias Correction Registers**

| Register  | Addresses  | Common Parameters           |
|-----------|------------|-----------------------------|
| XACCL_OFF | 0x21, 0x20 | Default value = 0x0000      |
| YACCL_OFF | 0x23, 0x22 | Scale = 2.522 mg per LSB    |
| ZACCL_OFF | 0x25, 0x24 | Twos complement, read/write |

**Table 13. Accelerometer Bias Correction Register Bits**

| Bits    | Description  |
|---------|--|
| [15:12] | Not used   |
| [11:0]  | Data bits, typical adjustment range = $\pm 5.16 g$ |

### Manual Bias Calibration

Because each offset bias register has read/write access, the bias of each sensor is adjustable. For example, if an output offset of 0.18°/s is observed in the Z-axis gyroscope, the ZGYRO\_OFF register provides the calibration factor necessary to improve the accuracy. Using its sensitivity of 0.018315°/s, an adjustment of -10 LSBs is required. The twos complement, hexadecimal code of -10 LSBs is 0x1FF6.

To implement this calibration factor, use the following pseudocode:

```
Write 0xF6 to Address 0x1E, then write 0x1F to
Address 0x1F
```

This step reduces the 0.18°/s error term to 0.00315°/s.

### Automatic Bias Null Calibration

A single-command, automatic bias calibration measures all three gyroscope output registers, then loads the three bias correction registers with values that return their outputs to zero (null). A single register write command starts this process (see Table 15).

```
Write 0x01 to Address 0x3E
```

### Precision Automatic Bias Null Calibration

Another option for gyroscope calibration, which typically provides better accuracy, is with the single-command, precision autonull. This incorporates the optimal averaging time for generating bias correction factors for all three gyroscope sensors. This command requires approximately 30 seconds to complete. For optimal calibration accuracy, the device should be stable (no motion) for this entire period. Once it has started, a reset command is needed to stop it prematurely, if required. The following sequence starts this calibration option (see Table 15):

```
Write 0x10 to Address 0x3E
```

### Restoring Factory Calibration

The factory calibration can be restored by returning the contents of each bias correction register to their default value of zero. This command also flushes all of the data from the digital filter taps. To accomplish this function for all six sensor signal paths (see Table 15),

```
Write 0x02 to Address 0x3E
```

### Linear Acceleration Bias Compensation (Gyroscopes)

The following command enables compensation for acceleration influences on gyroscope bias behavior:

```
Set Bit 7 of Address 0x34 to 1 (see Table 28)
```

### Linear Acceleration Origin Alignment

The following command provides origin alignment for the accelerometers to the point of percussion (see Figure 5), using the MSC\_CTRL register.

```
Set Bit 6 of Address 0x34 to 1 (see Table 28)
```

## GLOBAL COMMANDS

Global commands provide single-write initiations for common operations such as calibration, flash update, auxiliary DAC latch, and software reset. Each global command has a unique control bit assigned to it in the COMMAND register and is initiated by writing 1 to its assigned bit.

The flash update command writes the contents of each non-volatile register into flash memory for storage. This process takes approximately 100 ms and requires the power supply voltage to be within specification for the duration of the event. Note that this operation also automatically follows the autonull, precision autonull, and factory reset commands. After waiting the appropriate time for the flash update to complete, verify successful completion by reading the STATUS register (flash update error = 0, if successful).

The DAC latch command loads the contents of AUX\_DAC into the DAC latches, which control the actual output level. This overcomes the challenge of discontinuous outputs that would otherwise be associated with two separate write cycles for upper and lower bytes. Finally, the software reset command sends the ADIS16350/ADIS16355 digital processor into a restart sequence, effectively accomplishing the same tasks as the RST line.



**Table 14. COMMAND Register Definition**

| Address    | Default | Format | Access     |
|------------|---------|--------|------------|
| 0x3F, 0x3E | N/A     | N/A    | Write only |

**Table 15. COMMAND Bit Descriptions**

| Bits   | Description                         |
|--------|-------------------------------------|
| [15:8] | Not used                            |
| [7]    | Software reset command              |
| [6:5]  | Not used                            |
| [4]    | Precision autonull command          |
| [3]    | Flash update command                |
| [2]    | Auxiliary DAC data latch            |
| [1]    | Factory calibration restore command |
| [0]    | Autonull command                    |

## OPERATIONAL CONTROL

### Internal Sample Rate

The internal sample rate defines how often data output variables are updated, independent of the rate at which they are read out on the SPI port. The SMPL\_PRD register controls the internal sample rate and has two parts: a time base and a multiplier. The sample period can be calculated using the following equation:

$$T_S = T_B \times (N_S + 1)$$

where:

$T_S$  is the sample period.

$T_B$  is the time base.

$N_S$  is the multiplier.

The default value is the minimum register setting, 0x01, which corresponds to the maximum sample rate of 819.2 samples per second. The contents of this register are nonvolatile.

**Table 16. SMPL\_PRD Register Definition**

| Address    | Default | Format | Access |
|------------|---------|--------|--------|
| 0x37, 0x36 | 0x0001  | N/A    | R/W    |

**Table 17. SMPL\_PRD Bit Descriptions**

| Bits   | Description  |
|--------|--|
| [15:8] | Not used   |
| [7]    | Time base, 0 = 0.61035 ms, 1 = 18.921 ms               |
| [6:0]  | Multiplier (add 1 before multiplying by the time base) |

An example calculation of the sample period for the device is

$$\text{If } SMPL\_PRD = 0x0007, \text{ Bits } [7:0] = 00000111$$

$$\text{Bit } 7 = 0, \text{ so } T_B = 0.61035 \text{ ms}$$

$$\text{Bits } [6:0] = 0000111 = 7 = N_S$$

$$T_S = T_B \times (N_S + 1) = 0.61035 \text{ ms} \times (7 + 1) = 4.8828 \text{ ms}$$

$$f_S = 1/T_S = 204.8 \text{ SPS}$$

The sample rate setting has a direct impact on the SPI data rate capability. For SMPL\_PRD settings  $\leq 0x09$  (fast mode), the SPI SCLK can run at a rate up to 2.0 MHz. For SMPL\_PRD settings  $> 0x09$  (normal mode), the SPI SCLK can run at a rate up to 300 kHz.

The sample rate setting also affects the power dissipation.

The normal mode power ( $SMPL\_PRD > 0x09$ ) dissipation is approximately 67% less than the fast mode ( $SMPL\_PRD \leq 0x09$ ) power dissipation. The two different modes of operation offer a system-level trade-off between performance (sample rate, serial transfer rate) and power dissipation.

### Power Management

In addition to offering two different performance modes for power optimization, the SLP\_CNT register provides a programmable shutdown period. Writing the appropriate sleep time to the lower byte of the SLP\_CNT register shuts the device down for the specified time. The following example illustrates this relationship:

$$\text{Bits } [7:0] = 00000110 = 6 \text{ codes} = 3 \text{ seconds}$$

At the completion of the programmed duration, normal operation resumes. If measurements are required before sleep period completion or if it is necessary to end the indefinite shutdown, the device can be awakened by pulling the  $\overline{CS}$  line down to a 0 state, then returning it to a 1 state. Otherwise, the  $\overline{CS}$  line must be kept in a 1 (high) state to maintain sleep mode.

When writing a sleep time to the SLP\_CNT register, the time between the 16<sup>th</sup> SCLK edge and the CS rising edge must be less than 10  $\mu$ s in fast mode and less than 80  $\mu$ s in normal mode.

**Table 18. SLP\_CNT Register Definition**

| Address    | Scale <sup>1</sup> | Default | Format | Access |
|------------|--------------------|---------|--------|--------|
| 0x3B, 0x3A | 0.5 sec            | 0x0000  | Binary | R/W    |

<sup>1</sup> Scale is the weight of each LSB in the lower byte of this register.

**Table 19. SLP\_CNT Bit Descriptions**

| Bits   | Description |
|--------|-------------|
| [15:8] | Not used    |
| [7:0]  | Data bits   |

### Digital Filtering

The signal conditioning circuit of each sensor has an analog bandwidth of approximately 350 Hz. A programmable-length Bartlett Window FIR filter provides opportunity for additional noise reduction on all of the output data registers. The SENS/AVG register controls the number of taps in power-of-two step sizes, from zero to six.

Filter setup requires one simple step: write the appropriate M factor to the assigned bits in the SENS/AVG register. The bit assignments are listed in Table 21. The frequency response relationship for this filter is:

$$H_B(f) = H_A^2(f) \quad H_A(f) = \frac{\sin(\pi \times N \times f \times t_s)}{N \times \sin(\pi \times f \times t_s)}$$

# ADIS16350/ADIS16355

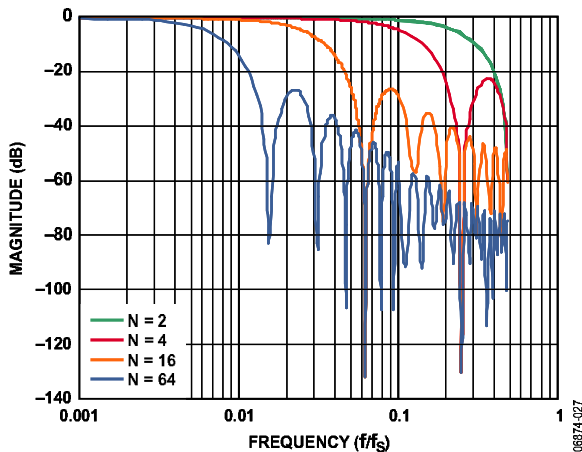

Figure 27. Bartlett Window FIR Frequency Response

## Dynamic Range

There are three dynamic range settings:  $\pm 75^\circ/\text{s}$ ,  $\pm 150^\circ/\text{s}$ , and  $\pm 300^\circ/\text{s}$ . The lower dynamic range settings (75, 150) limit the minimum filter tap sizes to maintain the resolution as the measurement range decreases. The recommended order for programming the SENS/AVG register is upper byte (sensitivity), followed by lower byte (filtering). The contents of the SENS/AVG register are nonvolatile.

Table 20. SENS/AVG Register Definition

| Address    | Default | Format | Access |
|------------|---------|--------|--------|
| 0x39, 0x38 | 0x0402  | N/A    | R/W    |

Table 21. SENS/AVG Bit Descriptions

| Bits    | Value | Description  |
|---------|-------|--|
| [15:11] |       | Not used   |
| [10:8]  |       | Measurement range (sensitivity) selection  |
|         | 100   | 300°/s (default condition)   |
|         | 010   | 150°/s, filter taps $\geq 4$ (Bits [2:0] $\geq 0x02$ )                               |
|         | 001   | 75°/s, filter taps $\geq 16$ (Bits [2:0] $\geq 0x04$ )                               |
| [7:3]   |       | Not used   |
| [2:0]   |       | Filter tap setting, number of taps, $N = 2^M$ ; for example, 011, $N = 2^3 = 8$ taps |

## Auxiliary DAC

The auxiliary DAC provides a 12-bit level adjustment function. The AUX\_DAC register controls the operation of this feature. It offers a rail-to-rail buffered output that has a range of 0 V to 2.5 V. The DAC can drive its output to within 5 mV of the ground reference when it is not sinking current. As the output approaches ground, the linearity begins to degrade (100 LSB beginning point). As the sink current increases, the nonlinear range increases. The DAC output latch function, contained in the COMMAND register, provides continuous operation while writing each byte of this register. The contents of this register are volatile, which means that the desired output level must be set after every reset and power cycle event.

Table 22. AUX\_DAC Register Definition

| Address    | Default | Format | Access |
|------------|---------|--------|--------|
| 0x31, 0x30 | 0x0000  | Binary | R/W    |

Table 23. AUX\_DAC Bit Descriptions

| Bits    | Description   |
|---------|---|
| [15:12] | Not used  |
| [11:0]  | Data bits; 0x0000 – 0 V output, 0x0FFF – 2.5 V output |

Updating the DAC output voltage requires four steps.

1. Determine the binary number associated with the desired output level.
2. Write the lower eight bits of this binary number to the lower address of the AUX\_DAC register.
3. Write the upper eight bits of this binary number to the upper address of the AUX\_DAC register.
4. Execute the DAC latch global command by writing 0x04 to Address 0x3E (see Table 15).

## General-Purpose Input/Output

Two general-purpose pins enable digital input/output control using the SPI. The GPIO\_CTRL control register establishes the configuration of these pins and handles the SPI-to-pin controls. Each pin provides the flexibility of both input (read) and output (write) operations.

For example, writing 0x0202 to this register establishes Line 2 as an output and sets its level as a 1. Writing 0x0000 to this register establishes both lines as inputs, and their status can be read through Bit 8 and Bit 9 of this register.

The digital input/output lines are also available for data-ready and alarm/error indications. In the event of conflict, the following priority structure governs the digital input/output configuration:

1. MSC\_CTRL (Data-ready indicator)
2. ALM\_CTRL (Alarm indicator)
3. GPIO\_CTRL (General-purpose)

Table 24. GPIO\_CTRL Register Definition

| Address    | Default | Format | Access |
|------------|---------|--------|--------|
| 0x33, 0x32 | 0x0000  | N/A    | R/W    |

Table 25. GPIO\_CTRL Bit Descriptions

| Bits    | Description  |
|---------|--|
| [15:10] | Not used   |
| [9]     | General-purpose input/output Line 2 data level<br>1 = high, 0 = low                  |
| [8]     | General-purpose input/output Line 1 data level<br>1 = high, 0 = low                  |
| [7:2]   | Not used   |
| [1]     | General-purpose input/output Line 2, data direction control<br>1 = output, 0 = input |
| [0]     | General-purpose input/output Line 1, data direction control<br>1 = output, 0 = input |

The contents of the GPIO\_CTRL register are volatile.

**STATUS AND DIAGNOSTICS**

Table 26 summarizes a number of status and diagnostic operations, along with their corresponding control registers.

**Table 26. Status and Diagnostic Functions**

| Register  | Function  |
|-----------|---|
| MSC_CTRL  | Data-ready input/output indicator; self-test, mechanical check for sensor element |
| STATUS    | Status: Check for predefined error conditions                                     |
| ENDURANCE | Flash memory endurance  |
| ALM_MAG1  | Alarms: Configure and check for user-specific conditions                          |
| ALM_MAG2  |   |
| ALM_SMPL1 |   |
| ALM_SMPL2 |   |
| ALM_CTRL  |   |

**Data-Ready Input/Output Indicator**

The data-ready function provides an indication of updated output data. The MSC\_CTRL register allows the user to configure either of the general-purpose input/output pins (DIO1 or DIO2) as a data-ready indicator signal.

**Table 27. MSC\_CTRL Register Definition**

| Address    | Default | Format | Access |
|------------|---------|--------|--------|
| 0x35, 0x34 | 0x0000  | N/A    | R/W    |

**Table 28. MSC\_CTRL Bit Descriptions**

| Bits    | Description   |
|---------|---|
| [15:11] | Not used  |
| [10]    | Internal self-test enable (clears on completion)<br>1 = enabled, 0 = disabled     |
| [9]     | Manual self-test, negative stimulus<br>1 = enabled, 0 = disabled                  |
| [8]     | Manual self-test, positive stimulus<br>1 = enabled, 0 = disabled                  |
| [7]     | Linear acceleration bias compensation for gyroscopes<br>1 = enabled, 0 = disabled |
| [6]     | Linear accelerometer origin alignment<br>1 = enabled, 0 = disabled                |
| [5:3]   | Not used  |
| [2]     | Data-ready enable<br>1 = enabled, 0 = disabled                                    |
| [1]     | Data-ready polarity<br>1 = active high, 0 = active low                            |
| [0]     | Data-ready line select<br>1 = DIO2, 0 = DIO1                                      |

**Self-Test**

The MSC\_CTRL register also provides a self-test function that verifies the mechanical integrity of the MEMS sensor. There are two different self-test options: internal self-test and external self-test.

The internal test provides a simple, two-step process for checking the MEMS sensor.

1. Start the process by writing 1 to Bit 10 in the MSC\_CTRL register.
2. Wait long enough for the response to settle, then check the result by reading Bit 5 of the STATUS register.

If a failure is indicated, then Bits [10:15] of the STATUS register indicate which of the six sensors it is associated with.

The entire cycle takes approximately 35 ms, and the output data is not available during this time. The external self-test is a static condition that can be enabled and disabled. In this test, both positive and negative gyroscope MEMS sensor movements are available. For the accelerometers, only positive MEMS sensor movement is available.

After writing to the appropriate control bit, the output registers reflect the changes after a delay that reflects the response time associated with the sensor/signal conditioning circuit. For example, the standard 350 Hz bandwidth reflects an exponential response with a time constant of 0.45 ms. Note that the digital filtering affects this delay as well. The appropriate bit definitions for self-test are listed in Table 27 and Table 28.

**Flash Memory Endurance**

The ENDURANCE register maintains a running count of writes to the flash memory. It provides up to 32,768 counts. Note that if this count is exceeded, the register wraps around and goes back to zero, before beginning to increment again.

**Table 29. ENDURANCE Register Definition**

| Address    | Default | Format | Access    |
|------------|---------|--------|-----------|
| 0x01, 0x00 | N/A     | Binary | Read only |

# ADIS16350/ADIS16355

## Status Conditions

The STATUS register contains the following error condition flags: alarm conditions, self-test status, overrange, SPI communication failure, control register update failure, and power supply range failure. See Table 30 and Table 31 for the appropriate register access and bit assignment for each flag.

The bits assigned for checking power supply range and sensor overrange automatically reset to 0 when the error condition no longer exists. The remaining error flag bits in the STATUS register require a read to return them to 0. Note that a STATUS register read clears all of the bits to 0. If any error conditions remain, the bits revert to 1 during the next internal output register update cycle.

**Table 30. STATUS Register Definition**

| Address    | Default | Format | Access    |
|------------|---------|--------|-----------|
| 0x3D, 0x3C | 0x0000  | N/A    | Read only |

**Table 31. STATUS Bit Descriptions**

| Bits  | Description   |
|-------|---|
| [15]  | Z-axis accelerometer self-diagnostic error flag<br>1 = failure, 0 = passing       |
| [14]  | Y-axis accelerometer self-diagnostic error flag<br>1 = failure, 0 = passing       |
| [13]  | X-axis accelerometer self-diagnostic error flag<br>1 = failure, 0 = passing       |
| [12]  | Z-axis gyroscope self-diagnostic error flag<br>1 = failure, 0 = passing           |
| [11]  | Y-axis gyroscope self-diagnostic error flag<br>1 = failure, 0 = passing           |
| [10]  | X-axis gyroscope self-diagnostic error flag<br>1 = failure, 0 = passing           |
| [9]   | Alarm 2 status<br>1 = active, 0 = inactive  |
| [8]   | Alarm 1 status<br>1 = active, 0 = inactive  |
| [7:6] | Not used  |
| [5]   | Self-test diagnostic error flag<br>1 = error condition, 0 = normal operation      |
| [4]   | Sensor over range (any of the six)<br>1 = error condition, 0 = normal operation   |
| [3]   | SPI communications failure<br>1 = error condition, 0 = normal operation           |
| [2]   | Control register update failed<br>1 = error condition, 0 = normal operation       |
| [1]   | Power supply in range above 5.25 V<br>1 = above 5.25 V, 0 = below 5.25 V (normal) |
| [0]   | Power supply below 4.75 V<br>1 = below 4.75 V, 0 = above 4.75 V (normal)          |

## Alarms

Two independent alarms provide programmable condition monitoring. Event detections occur when output register data meets the configured conditions. Configuration options include the following:

- All output data registers are available for monitoring as the source data.
- The source data can be filtered or unfiltered.
- Comparisons can be static or dynamic (rate of change).
- The threshold levels and times are configurable.
- Comparison can be greater than or less than.

The ALM\_MAG1 register and the ALM\_MAG2 register both establish the threshold level for detecting events. These registers take on the format of the source data and provide a bit for establishing the greater than/less than comparison direction.

When making dynamic comparisons, the ALM\_SMPL1 register and the ALM\_SMPL2 register establish the number of averages taken for the source data as a reference for comparison. In this configuration, each subsequent source data sample is subtracted from the previous one, establishing an instantaneous delta. The ALM\_CTRL register controls the source data selection, static/dynamic selection, filtering selection, and digital input/output usage for the alarms.

The rate of change calculation is

$$Y_C = \frac{1}{N_{DS}} \sum_{n=1}^{N_{DS}} y(n+1) - y(n)$$

The rate of change alarm is determined by comparing

$Y_C$  with  $M_C$  according to the ALM\_MAG1/ALM\_MAG2 settings

where:

$N_{DS}$  is the number of samples in ALM\_SMPL1 and ALM\_SMPL2.

$y(n)$  is the sampled output data.

$M_C$  is the magnitude for comparison in ALM\_MAG1 and ALM\_MAG2.

$Y_C$  is the factor to compare with  $M_C$ .

**Table 32. ALM\_MAG1 and ALM\_MAG2 Register Definitions**

| Register | Addresses  | Default | Format | Access |
|----------|------------|---------|--------|--------|
| ALM_MAG1 | 0x27, 0x26 | 0x0000  | N/A    | R/W    |
| ALM_MAG2 | 0x29, 0x28 | 0x0000  | N/A    | R/W    |

**Table 33. ALM\_MAG1 and ALM\_MAG2 Bit Descriptions**

| Bits   | Description  |
|--------|--|
| [15]   | Comparison polarity: 1 = greater than, 0 = less than |
| [14]   | Not used   |
| [13:0] | Data bits, format matches source data format         |

**Table 34. ALM\_SMPL1 and ALM\_SIMPL2 Register Definitions**

| Registers | Addresses  | Default | Format | Access |
|-----------|------------|---------|--------|--------|
| ALM_SMPL1 | 0x2B, 0x2A | 0x0000  | Binary | R/W    |
| ALM_SMPL2 | 0x2D, 0x2C | 0x0000  | Binary | R/W    |

**Table 35. ALM\_SMPL1 and ALM\_SIMPL2 Bit Descriptions**

| Bit    | Description |
|--------|-------------|
| [15:8] | Not used    |
| [7:0]  | Data bits   |

**Table 36. ALM\_CTRL Register Definition**

| Addresses  | Default | Format | Access |
|------------|---------|--------|--------|
| 0x2F, 0x2E | 0x0000  | N/A    | R/W    |

**Table 37. ALM\_CTRL Bit Designations**

| Bits    | Value | Description   |
|---------|-------|---|
| [15:12] |       | Alarm 2 source selection  |
|         | 0000  | Disable   |
|         | 0001  | Power supply output   |
|         | 0010  | X-axis gyroscope output   |
|         | 0011  | Y-axis gyroscope output   |
|         | 0100  | Z-axis gyroscope output   |
|         | 0101  | X-axis accelerometer output   |
|         | 0110  | Y-axis accelerometer output   |
|         | 0111  | Z-axis accelerometer output   |
|         | 1000  | X-axis gyroscope temperature output   |
|         | 1001  | Y-axis gyroscope temperature output   |
|         | 1010  | Z-axis gyroscope temperature output   |
|         | 1011  | Auxiliary ADC input   |
| [11:8]  |       | Alarm 1 source selection (same as Alarm 2)                                      |
| [7]     |       | Rate of change (ROC) enable for Alarm 2<br>1 = rate of change, 0 = static level |
| [6]     |       | Rate of change (ROC) enable for Alarm 1<br>1 = rate of change, 0 = static level |
| [5]     |       | Not used  |
| [4]     |       | Comparison data filter setting<br>1 = filtered data, 0 = unfiltered data        |
| [3]     |       | Not used  |
| [2]     |       | Alarm output enable<br>1 = enabled, 0 = disabled                                |
| [1]     |       | Alarm output polarity<br>1 = active high, 0 = active low                        |
| [0]     |       | Alarm output line select<br>1 = DIO2, 0 = DIO1                                  |

## APPLICATIONS INFORMATION

### INSTALLATION GUIDELINES

Installation requires two steps: mechanical attachment of the body, followed by the electrical connection. This device is designed for postsolder reflow installation. It is not designed to survive the temperatures associated with normal solder reflow processes.

#### **Mechanical Attachment**

The open mounting tabs on each side of the body provide enough room for 2 mm (or 2-56) machine screws. Note that 316 stainless steel and aluminum screws are available for use in this attachment.

When planning the installation process, the primary trade-off to consider is the attachment strength advantage of stainless steel against the nonmagnetic properties of aluminum for systems that are sensitive to magnetic field disturbances.

Figure 28 provides a graphical display of the mechanical attachment, and Figure 29 provides a recommendation for the physical layout of all the holes required for attaching these devices.

#### **Electrical Connections**

The electrical interface is a single connector that is attached to a flexible circuit extension.

One option for mating connectors can be found in the Samtec CLM family. In this case, the part number starts with CLM-112-02. The flexible circuit has stress relief points to absorb environmental stresses, such as temperature cycling and vibration. Figure 29 provides the alignment hole locations for designs that employ the suggested connector mate. The dimensions offered in Figure 29 assume that the device and the mating connector are on the same surface. The electrical connection is held by friction only.

#### **Proper Removal**

The flexible circuit interface can tear under excessive force conditions. An example of excessive force is attempting to break the electrical connection by pulling on the body of the device, placing all of the stress on the flexible circuit.

The electrical connector must be broken by an appropriate tool, which is designed to apply even pressure to each side of the rigid part of the flex cable. The recommended extraction sequence is to break the mate between the electrical interface, and then to remove the mechanical attachment hardware.

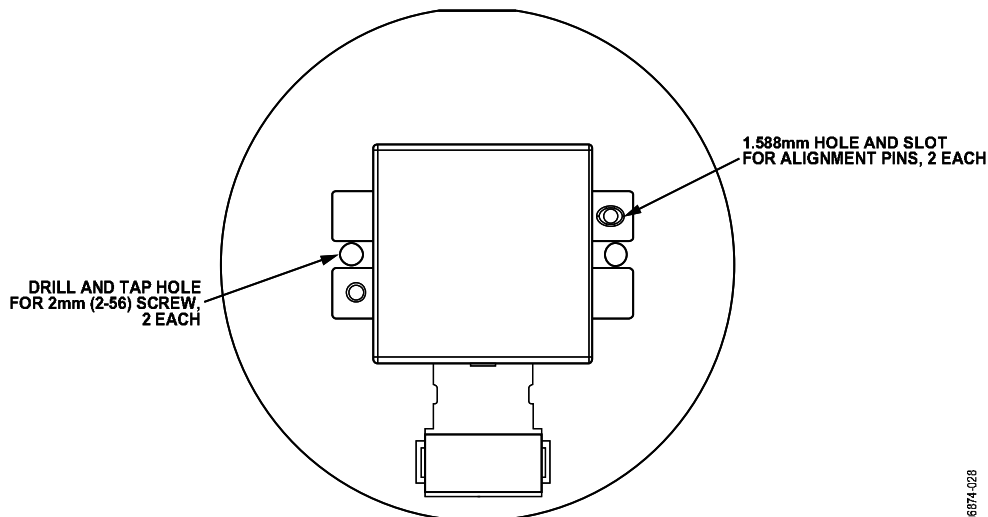
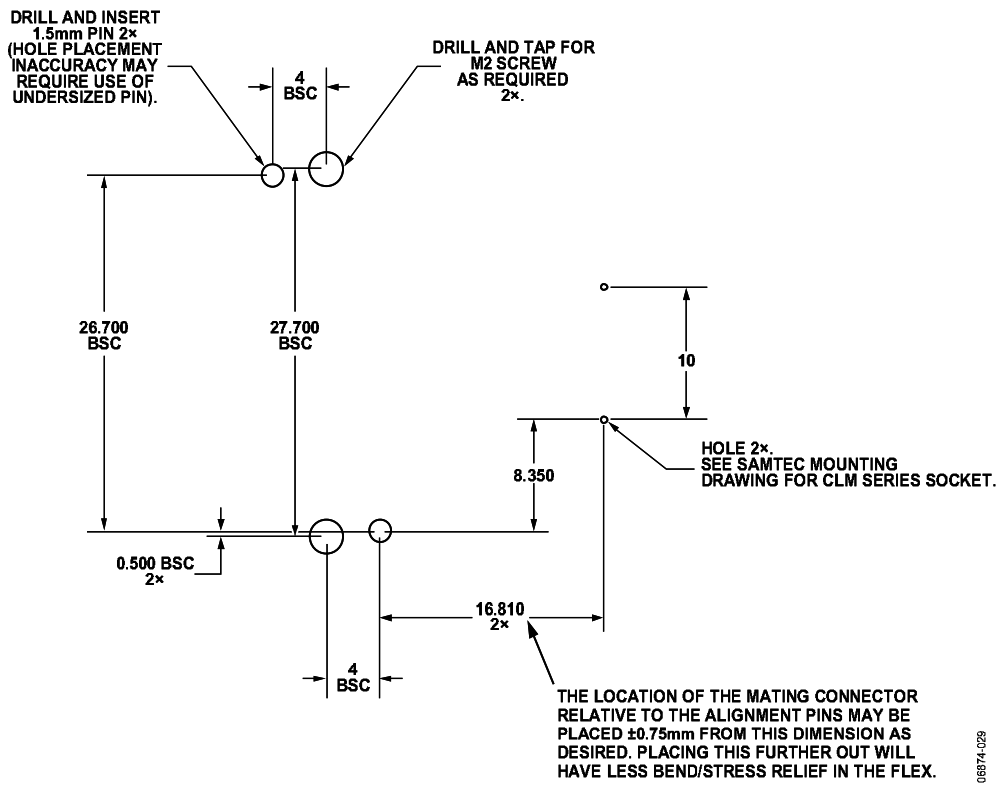

Figure 28. Mechanical Attachment

06874-028



06874-028

Figure 29. Hole Locations

# ADIS16350/ADIS16355

## OUTLINE DIMENSIONS

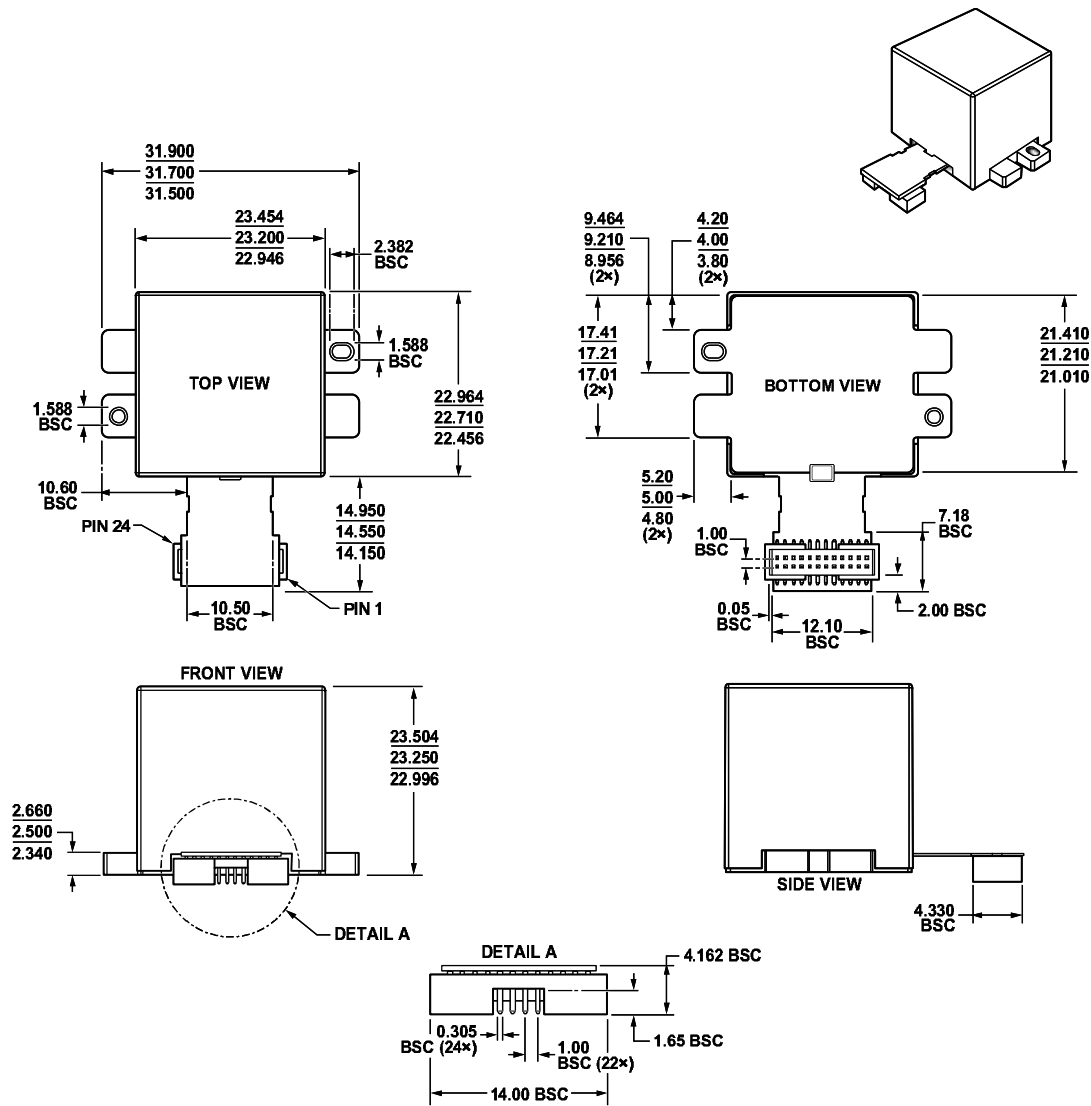

Figure 30. 24-Lead Module with Connector Interface  
(ML-24-2)  
Dimensions shown in millimeters

01108-C

### ORDERING GUIDE

| Model                        | Temperature Range | Package Description                     | Package Option |
|------------------------------|-------------------|---|----------------|
| ADIS16350AMLZ <sup>1</sup>   | -40°C to +85°C    | 24-Lead Module with Connector Interface | ML-24-2        |
| ADIS16350/PCBZ <sup>1</sup>  |                   | Interface Board                         |                |
| ADIS16350/EVALZ <sup>1</sup> |                   | PC Evaluation System                    |                |
| ADIS16355AMLZ <sup>1</sup>   | -40°C to +85°C    | 24-Lead Module with Connector Interface | ML-24-2        |
| ADIS16355/PCBZ <sup>1</sup>  |                   | Interface Board                         |                |
| ADIS16355/EVALZ <sup>1</sup> |                   | PC Evaluation System                    |                |

<sup>1</sup> Z = RoHS Compliant Part.