

Cable-Extension Position Transducer

0...5, 0...10, -5...+5, -10...+10 VDC Output Options

Ranges: 0-2 to 0-50 inches

Compact Size • OEM Applications



PT1DC

Specification Summary:

GENERAL

Full Stroke Range Options 0-2 to 0-50 inches
 Output Signal Options 0...5, 0...10, -5...+5, -10...+10 VDC
 Accuracy $\pm 0.28\%$ to $\pm 0.15\%$ full stroke *see ordering information*
 Repeatability $\pm 0.05\%$ full stroke
 Resolution essentially infinite
 Measuring Cable019-in. dia. nylon-coated stainless steel
 Enclosure Material ABS plastic and black anodized aluminum
 Sensor plastic-hybrid precision potentiometer
 Potentiometer Cycle Life *see ordering information*
 Maximum Retraction Acceleration *see ordering information*
 Weight 1 lb. max.

ELECTRICAL

Input 14.5-40 VDC (10.5-40 VDC for 0...5 and -5...+5 volt output)
 Input Current 10 mA maximum
 Output Impedance 1000 ohms
 Maximum Load 5000 ohms
 Zero and Span Adjustment *see ordering information*

ENVIRONMENTAL

Enclosure NEMA 4, IP 65
 Operating Temperature 0° to 200°F (-17° to 90°C)
 Vibration up to 10 G's to 2000 Hz maximum

EMC COMPLIANCE PER DIRECTIVE 89/336/EEC

Emission/Immunity EN50081-2 / EN50082-2



The PT1DC can operate from an unregulated 14.5 to 40 VDC power supply while providing an output signal that is proportional to the linear movement of its measuring cable. The PT1DC has a maximum measurement range up to 50" and has 4 output signal options to choose from: 0...10, 0...5, -10...+10 and -5...+5 Vdc.

Just like the rest of the PT1 series, the PT1DC also offers several options including forward and reverse output signals, zero and span adjustments and alternate measuring cable exits.

Outline Drawing

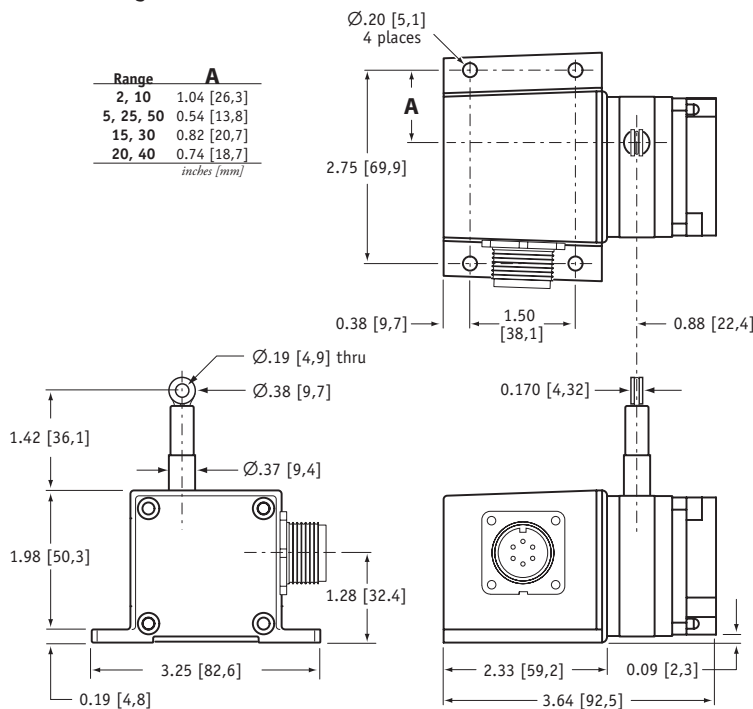

dimensions are in inches [mm], tolerances are 0.03 inches [0,8 mm]

Output Signal

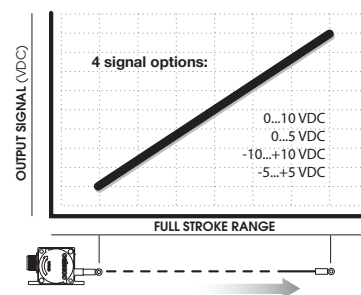

Celeco Transducer Products, Inc.
 20630 Plummer Street • Chatsworth, CA 91311
 tel: 800.423.5483 • +1.818.701.2750 • fax: +1.818.701.2799

celesco
 celesco.com • info@celesco.com

Ordering Information:

Model Number:

PT1DC - - - - - -
order code: **R** **A** **B** **G** **D**

Sample Model Number:

PT1DC - 30 - UP - Z10 - MC4 - SC

- R** range: 30 inches
- A** measuring cable exit: up
- B** output signal: 0...10 VDC
- C** electrical connection: 4-pin micro connector
- D** cable guide: spring-loaded guide

Full Stroke Range:

R order code:	2	5	10	15	20	25	30	40	50
full stroke range, min:	2 in.	5 in.	10 in.	15 in.	20 in.	25 in.	30 in.	40 in.	50 in.
accuracy (% of f.s.):	0.28%		0.18%			0.15%			
potentiometer cycle life:	2,500,000 cycles		500,000 cycles			250,000 cycles			
cable tension (20%):	12 oz.	5 oz.	12 oz.	9 oz.	6 oz.	5 oz.	9 oz.	6 oz.	5 oz.
maximum cable acceleration:	11 G's	3 G's	11 G's	5 G's	4 G's	3 G's	5 G's	4 G's	3 G's

Cable Exit:

A order code: **UP** **DN** **FR** **BK**
 direction: up down front back

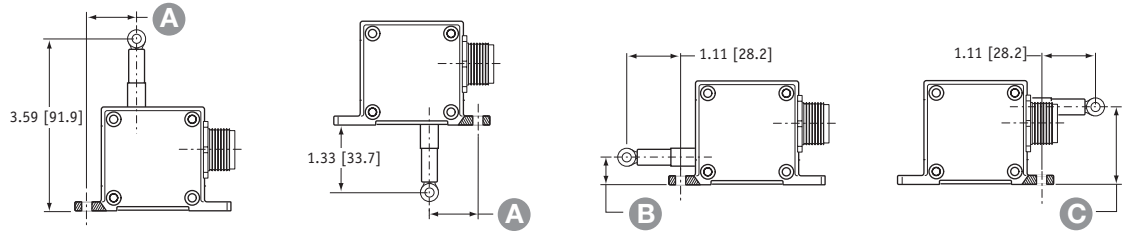

measurement range	2	5	10	15	20	25	30	40	50
A	1.04 in. 26,3 mm	0.54 in. 13,8 mm	1.04 in. 26,3 mm	0.82 in. 20,7 mm	0.74 in. 18,7 mm	0.54 in. 13,8 mm	0.82 in. 20,7 mm	0.74 in. 18,7 mm	0.54 in. 13,8 mm
B	0.75 in. 19,1 mm	0.29 in. 6,1 mm	0.75 in. 19,1 mm	0.53 in. 13,5 mm	0.45 in. 11,5 mm	0.29 in. 6,1 mm	0.53 in. 13,5 mm	0.45 in. 11,5 mm	0.29 in. 6,1 mm
C	1.43 in. 36,3 mm	1.89 in. 48,0 mm	1.43 in. 36,3 mm	1.65 in. 41,9 mm	1.73 in. 43,7 mm	1.89 in. 48,0 mm	1.65 in. 41,9 mm	1.73 in. 43,7 mm	1.89 in. 48,0 mm

Output Signals:

B order code:	Z10	10Z	Z5	5Z	M0P0	P0M0	M5P5	P5M5
output signal options:	0...10 VDC	10...0 VDC	0...5 VDC	5...0 VDC	-10...+10 VDC	+10...-10 VDC	-5...+5 VDC	+5...-5 VDC
input voltage:	14.5 - 40 vdc		10.5 - 40 vdc		14.5 - 40 vdc		10.5 - 40 vdc	
span adjustment:	from 100% to 50% of full stroke range				from 100% to 75% of full stroke range			
zero adjustment:	from factory set zero to 50% of full stroke range				from factory set zero to 25% of full stroke range			

example:

ordercode = **Z10** = 0...10 VDC →
 0 vdc = →
 10 vdc =

Ordering Information (cont.)

Electrical Connection:

Ⓜ order code:

MC4
4-pin micro-connector
with 12 ft [3.5 M] cordset

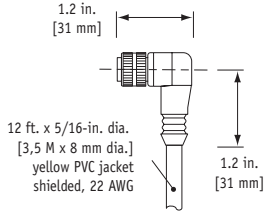

M6
6-pin plastic connector
with mating plug

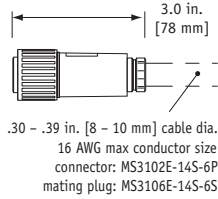

C25
25-ft. instrumentation cable
24 AWG, shielded

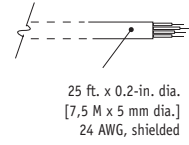

4-pin mating plug and cord set:



pin	color code	signals
1	RED-BLK TR.	input voltage
2	RED-WHT TR.	output signal
3	RED	common

6-pin mating plug:

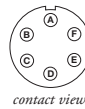

pin	signals
A	input voltage
B	output signal
C	common

25-ft. cable:

color code	standard
RED	input voltage
BLACK	common
GREEN	output signal

Cable Guide:

Ⓜ order code:

blank
standard cable guide

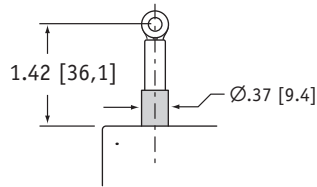

SG
spring-loaded guide

cable-guide cushions impact from accidental free release

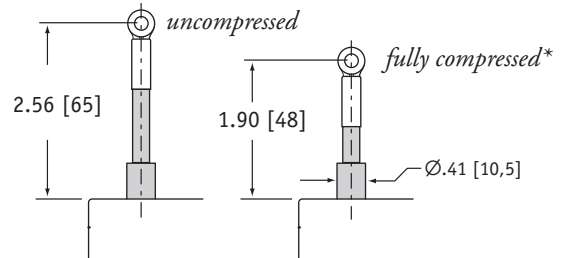

**note: start of full stroke range begins at full compression point*

Output Signal Selection (does not apply to -5...+5 & -10...+10 vdc options)

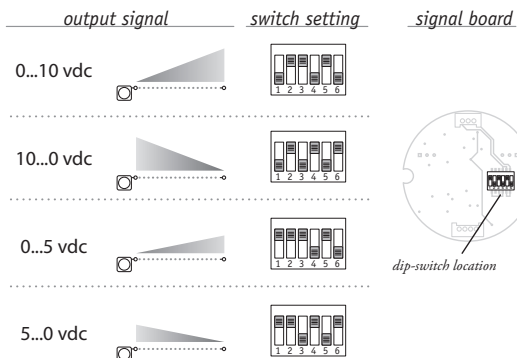

The output signal direction can be reversed at any time by simply changing the dip-switch settings found on the internal signal board. After the settings have been changed, adjustment of the Zero and Span trim pots will be required to precisely match signal values to the beginning and end points of the stroke.

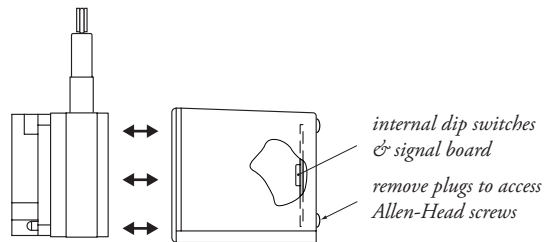

to gain access to the signal board, remove the two Allen-Head Screws and remove rear cover.

version: 3.0 last updated: July 10, 2008

celesco