

Push Switch 2.5mm-travel Vertical Type

SPEC Series



Vertical type, widely applicable to home and industrial electronic equipment.



Features

- 2.5 mm-travel.
- Standard knobs are available.

Applications

- Information devices, including other electric devices including sound devices and telephones
- Switches for in-vehicle (air conditioning) devices and industrial electronic devices

Detector

Push

Slide

Rotary

Encoders

Power

Dual-in-line
Package Type

Multi Control
Devices

TACT Switch™

Custom-
Products

Horizontal
Type

Vertical
Type

Typical Specifications

Items		Specifications
Rating (max.) / (min.) (Resistive load)		0.1A 30V DC/50 μ A 3V DC
Contact resistance (Initial performance/After lifetime)		30m Ω max./50m Ω max.
Operating force	2-poles	2 \pm 1N
Operating life	Without load	10,000 cycles
	With load	10,000 cycles (0.1A 30V DC)

Products Line

Changeover timing	Travel (mm)	Total travel (mm)	Rating	Mounting method	Poles	Operating	Terminal style	Minimum packing unit (pcs.)	Products No.
Non shorting	2.5	3.4	—	PC board	2	Latching	Straight	100	SPEC121100
							Snap-in		SPEC121300

Note

Additional switches not included in the above list are also available. Contact us for details.

For other specifications, see P.105
For knobs, see P.106

Push Switch

2.5mm-travel Vertical Type | SPEC Series

- Detector
- Push**
- Slide
- Rotary
- Encoders
- Power
- Dual-in-line Package Type
- Multi Control Devices
- TACT Switch™
- Custom-Products

Dimensions

Unit:mm

Style	PC board mounting hole dimensions (Viewed from the direction A)	
	Straight terminal 	Snap-in terminal

- Horizontal Type
- Vertical Type**

Operating Section Nose Shape

Unit:mm

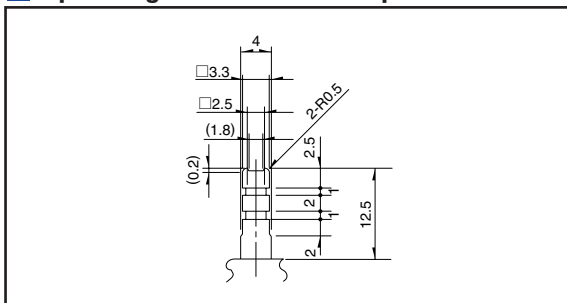

Circuit Diagram (Viewed from the Direction A)

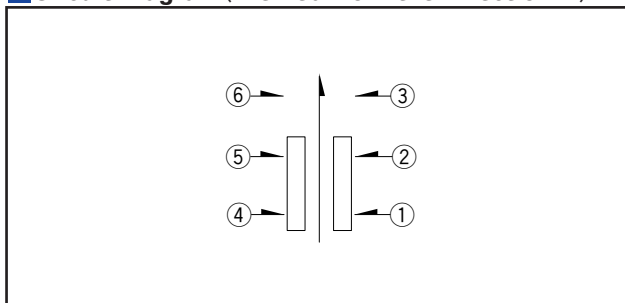

Terminal Style

Unit:mm

Straight terminal	Snap-in terminal

Products Specifications

Series		SPEE	SPPJ6	SPPJ2	SPPJ3	SPUJ SPUP	SPUN	SPUN (medium current)	SPPH2	SPPH4	SPPH1	SPEA	SPEC	SPED2	SPED3	SPED4	SPED5	
Operating temperature range		-10°C to +60°C											-40°C to +85°C					
Rating (max.) (Resistive load)		5V 20mA	0.2A 12V DC	0.2A 30V DC		0.1A 30V DC		1A 25V DC	0.1A 12V DC	0.1A 30V DC				1A 14.5V DC				
Electrical performance	Initial contact resistance	※	20mΩ max.						30mΩ max.	100mΩ max.	20mΩ max.	30mΩ max.		100mΩ max.				
	Insulation resistance	10mΩ min 100V DC	100MΩ min. 500V DC															
	Voltage proof	100V AC for 1min	500V AC for 1 min.											100V AC for 1 min.				
Mechanical performance	Robustness of terminal	—	5N for 1 min.							3N for 1 min.		—						
	Robustness of actuator	Operating direction	50N	30N	50N		30N		50N									
		Pulling direction	—		50N		—	10N	—	50N		—						
	Vibration		10 to 55 to 10Hz/min., the amplitude is 1.5mm for all the frequencies, in the 3 direction of X, Y and Z for 2 hours respectively															
	Resistance to soldering heat	Manual soldering	—	350±10°C 3 ⁺¹ ₀ s		300±10°C 3 ⁺¹ ₀ s	350±10°C 3 ⁺¹ ₀ s		350°C max. 3s max.	350±10°C 3 ⁺¹ ₀ s			350±10°C 3±0.5s	—	350±10°C 3±0.5s	—		
		Dip soldering	—	260±5°C 5±1s	260±5°C 10±1s	260±5°C 5±1s	260±5°C 10±1s	260±5°C 5±1s	260±5°C 10±1s	260±5°C 5±1s	260±5°C 10±1s	260±5°C 5s max.	260±5°C 10±1s	—	260±5°C 10±1s	—		
Reflow		260°C max 10s max	—															
Durability	Operating life without load	100,000 cycles	10,000 cycles 40mΩ max.			30,000 cycles 40mΩ max.	10,000 cycles 40mΩ max.	10,000 cycles 50mΩ max.	10,000 cycles 100mΩ max.	10,000 cycles 40mΩ max.	10,000 cycles 50mΩ max.	10,000 cycles 100mΩ max.	30,000 cycles 100Ω max.					
	Operating life with load Load : As rating	100,000 cycles	10,000 cycles 40mΩ max.			5,000 cycles 40mΩ max.	10,000 cycles 50mΩ max.	10,000 cycles 100mΩ max.	10,000 cycles 40mΩ max.	10,000 cycles 50mΩ max.	30,000 cycles 100mΩ max.							
Environmental performance	Cold	-40±2°C for 96h	-20±2°C for 96h											-40±2°C for 96h				
	Dry heat	85±2°C for 96h																
	Damp heat	40±2°C, 90 to 95%RH for 96h																

Note
1V or less, at the present rating of 1mA, 5V DC for output voltage.

Detector

Push

Slide

Rotary

Encoders

Power

Dual-in-line
Package Type

Multi Control
Devices

TACT Switch™

Custom-
Products

Horizontal
Type

Vertical
Type

Attached Parts

Specify the Desired Knob.

Unit:mm

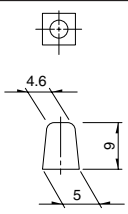
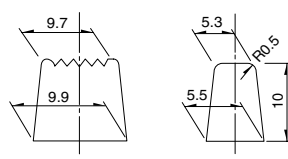
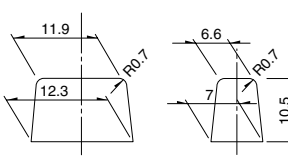
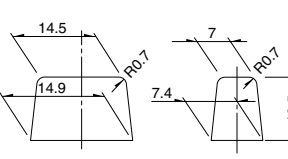
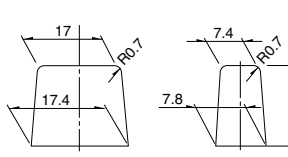
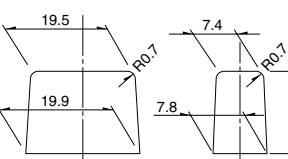
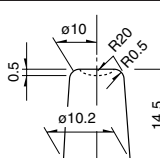
Knob outline drawing	Variety		Series
	Color	Model	
	Black Red White	UJ206022 UJ206020 UJ206026	SPPJ3 SPUJ
Key pitch 10mm Square knob 		4093-1 4093-2 4093-3	SPPJ2 SPUP SPUN SPEC
Key pitch 12.5mm Square knob 		UE201011 UE201012 UE201013	
Key pitch 15mm Square knob 		UE202011 UE202012 UE202013	
Key pitch 17.5mm Square knob 		UE203011 UE203012 UE203013	
Key pitch 20mm Square knob 		UE204011 UE204012 UE204013	
Round knob 		UE200011 UE200012 UE200013	

Note

When mounting the switch, it is recommended to secure the knob with an adhesive agent.

