

TACT Switch™ 3.9×2.9mm Compact (SMD)Type

SKRK Series

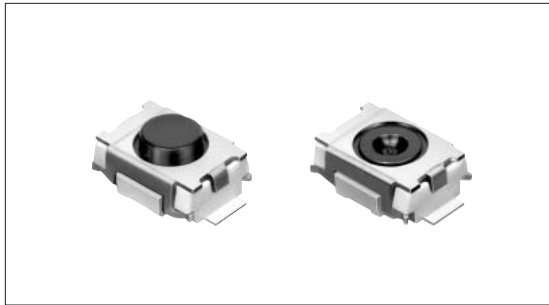

1.5mm or 2mm stem height contribute to smaller and thinner sets.



Features

- 1.5mm stem height type has 40% smaller height and 50% smaller mounting space than conventional SKQY series.
- Improve mounting density of components on PC board.
- Reflow solderable.
- Packaged with a 12mm wide embossed taping.

Applications

- Portable audio
- Mobile phones and personal digital assistants
- Operation of various digital devices

Products Line

Products No.	Operating force	Operating direction	Travel (mm)	Rating (max.)	Rating (min.)	Operating life (5mA 5V DC)	Initial contact resistance	Stem height	Drawing No.
SKRKAEE010	1.57N	Vertical	0.13	50mA 12V DC	10μA 1V DC	200,000 cycles	100mΩ max.	h=2mm	1
SKRKAHE010	0.98N						500mΩ max.		
SKRKAGE010	1.57N						100mΩ max.	h=1.5mm	

Dimensions

Unit:mm

No.	Photo	Style	PC board mounting hole dimensions (Viewed from switch mounting face)
1			
2			

Circuit Diagram

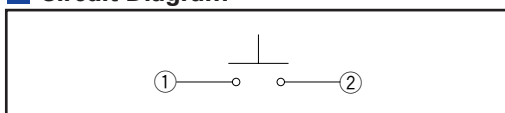

For other specifications, see P.369
For soldering conditions, see P.370
For specifications for the taping package, see P.372

Detector
Push
Slide
Rotary
Encoders
Power
Dual-in-line Package Type
Multi Control Devices
TACT Switch™
Custom-Products

Sharp Feeling
Soft Feeling
Snap-in Type
Surface Mount Type
Radial Type

Products Specifications

Items		Series	Sharp feeling type	Soft feeling type
		Operating temperature range		
			-30°C to +85°C	-40°C to +90°C
Electrical performance	Insulation resistance	100MΩ min. 100V DC SKEY/PD : 50MΩ min. 100V DC		
	Voltage proof	250V AC for 1 min. SKRE/SKSC/SKRB/RV/RH/RM/RW/RR/EY/PD : 100V AC for 1min.		
Durability	Vibration	10 to 55 to 10Hz/min., the amplitude is 1.5mm for all the frequencies, in the 3 direction of X, Y and Z for 2 hours respectively		
	Lifetime	Shall be in accordance with individual specifications.		
Environmental performance	Cold	-30±2°C for 96h		
	Dry heat	80±2°C for 96h		
	Damp heat	60±2°C, 90 to 95%RH for 96h		

Detector

Push

Slide

Rotary

Encoders

Power

Dual-in-line
Package TypeMulti Control
Devices

TACT Switch™

Custom-
Products

Note

We can raise the working temperature range for in-vehicle applications upon request. Contact us if you have any requirements of this kind.

Specifications of LED (SKHJ)

Color of light	Power dissipation P (mW)	Forward pulse peak current IFP (mA)	Forward current IFDC (mA)	Reverse voltage VR (V)	Forward voltage VF (V) IF=10mA	Reverse current IR (μA) VR=4V	Peak emission wave length λ peak (nm) IF=10mA	Spectral line half width Δλ (nm) IF=10mA	Luminous intensity IV (mcd) IF=10mA
Red	40	80	15	4	2.7 max. 2.05TYP	5 max.	700 TYP	100 TYP	0.4min. 1.0 TYP
Pure green									0.8min. 2.0 TYP
Amber									0.4min. 1.0 TYP
Orange (High brightness)				3	2.7 max. 2.0 TYP	10 max.	590 TYP	30 TYP	1.5min. 4.0 TYP
Green (High brightness)									4

Sharp
FeelingSoft
FeelingSnap-in
TypeSurface
Mount TypeRadial
Type

Soldering Conditions

Condition for Reflow

Available for Surface Mount Type. (Except SKRM, SKRR Series)

1. Heating method: Double heating method with infrared heater.
2. Temperature measurement: Thermocouple 0.1 to 0.2 φ CA (K) or CC (T) at soldering portion (copper foil surface). A heat resisting tape should be used for fixed measurement.
3. Temperature profile

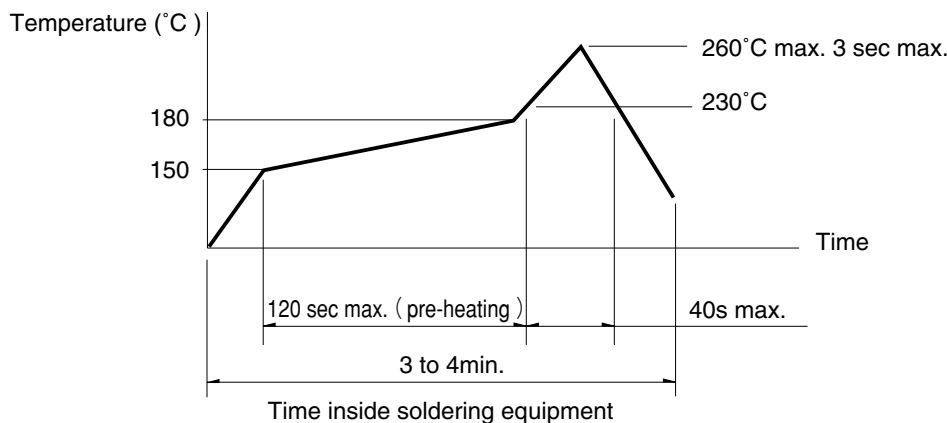

Note

1. The condition mentioned above is the temperature on the mounting surface of a PC board. There are cases where the PC board's temperature greatly differs from that of the switch, depending on the PC board's material, size, thickness, etc. The above-stated conditions shall also apply to switch surface temperatures.
2. Soldering conditions differ depending on reflow soldering machines. You are requested to verify the soldering conditions thoroughly beforehand.

Conditions for Auto-dip

Available for Snap-in Type and Radial Type
(Except SKHJ, SKHL, SKQC, SKQJ, SKQK, SKEG series)

Items	Condition
Flux built-up	Mounting surface should not be coated with flux
Preheating temperature	Ambient temperature of the soldered surface of PC board. 100°C max.
Preheating time	60s max.
Soldering temperature	260°C max.
Continuous dipping time	5s max.
Number of soldering	2times max.

Manual Soldering (Except SKRT series)

Items	Condition
Soldering temperature	350°C max.
Continuous soldering time	3s max.
capacity of soldering iron	60W max.

Notes

1. Consult with us for TACT Switch™ washing conditions.
2. Prevent flux penetration from the top side of the TACT Switch™.
3. Switch terminals and a PC board should not be coated with flux prior to soldering.
4. The second soldering should be done after the switch returns to normal temperature.
5. Use the flux with a specific gravity of at least 0.81.
(EC-19S-8 by TAMURA Corporation, or their equivalents.)

Detector
Push
Slide
Rotary
Encoders
Power
Dual-in-line Package Type
Multi Control Devices
TACT Switch™
Custom-Products

Sharp Feeling
Soft Feeling
Snap-in Type
Surface Mount Type
Radial Type

Specification of Embossed Taping Package

Taping Packaging for Auto-insertion

Reel Size

Unit:mm

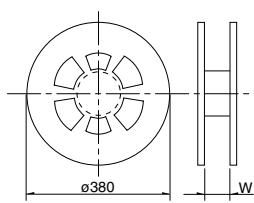
Plastic Reel 	Applicable series	W
	SKHM, SKHU, SKQG, SKQL, SKQM, SKQR, SKQY, SKRAAK, SKRAAL, SKRB, SKRE, SKRK, SKRM, SKRN, SKRP, SKRT, SKRW, SKPM, SKSC	13.5
	SKQT, SKRAAM, SKRAAQ, SKRH, SKRR, SKRV, SKPG, SKPN	17.5
	SKQUBA, SKQUBB	33.5

Unit:mm

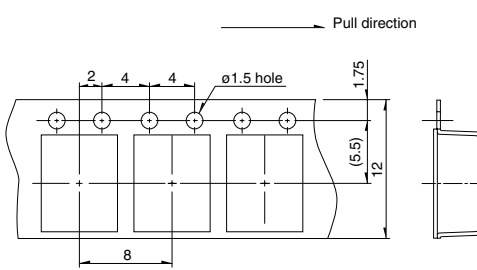
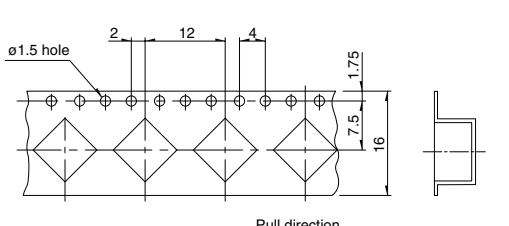
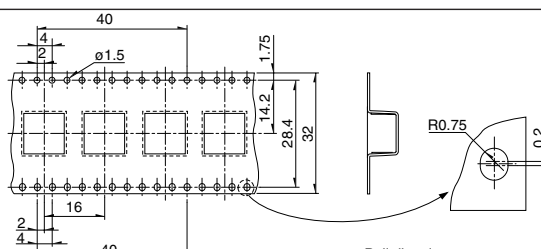
Applicable series	Qty/reel (pcs.) (Minimum packing unit)	Tape dimensions
SKQM, SKPM	2,000	
SKHM, SKHU, SKQY, SKRT, SKRAAK, SKRAAL	3,000	
SKQG	5,000 (Without stem type) 4,000 (With stem type)	
SKRP	4,000	
SKRKAE, SKRKAH	4,500	
SKQR, SKRB SKRM, SKRW	10,000	
SKRE, SKRN, SKRKAG, SKSC	5,000	
SKQL	3,000	
SKRH	1,300	
SKRV	1,500	
SKPG	1,200	
SKRAAM, SKRAAQ	1,400	
SKQT	3,000	
SKRR	7,000	
SKPN	1,100	
SKQUBA	750	
SKQUBB	600	

Note

Consult with us for a ϕ 330 mm diameter reel.