

分离式接线板

Assembly Type Terminal Block

KTB2 系列

KTB3 系列



● 认证事项 ●
Certification

  
(10-60A)



KTB2 系列

KTB2-010

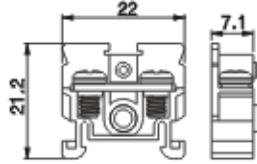

KTB2-015

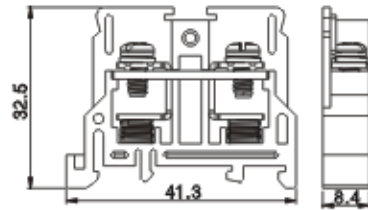
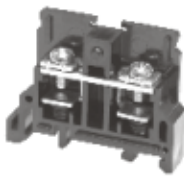

KTB2-025

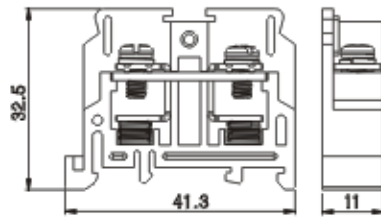
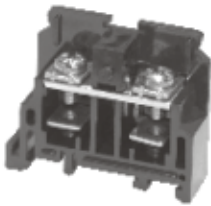

KTB2-035

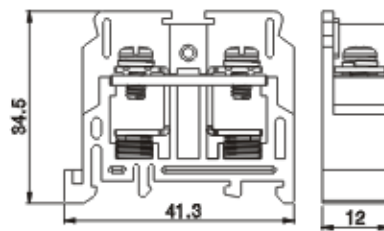
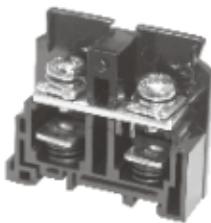

KTB2-060

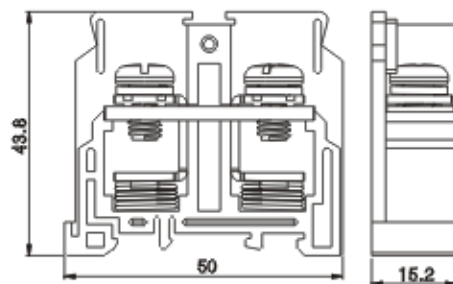
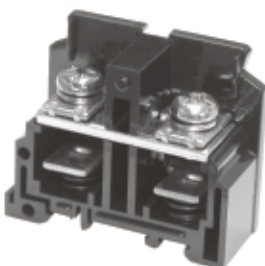



KTB2-100

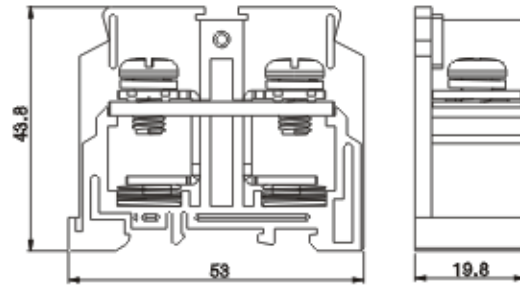
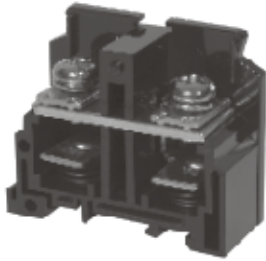

KTB2-200

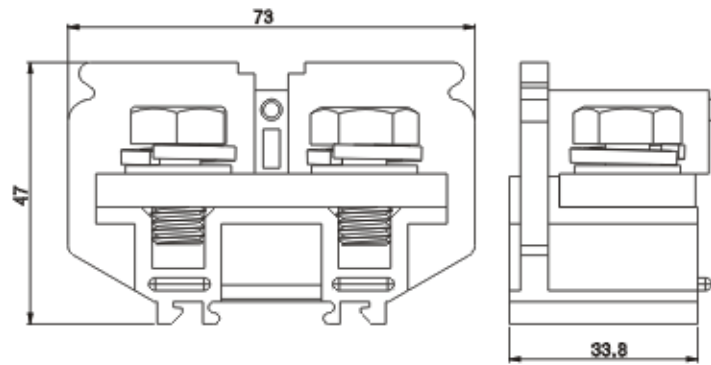
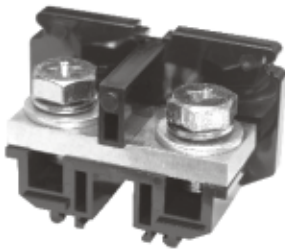

KTB2-300

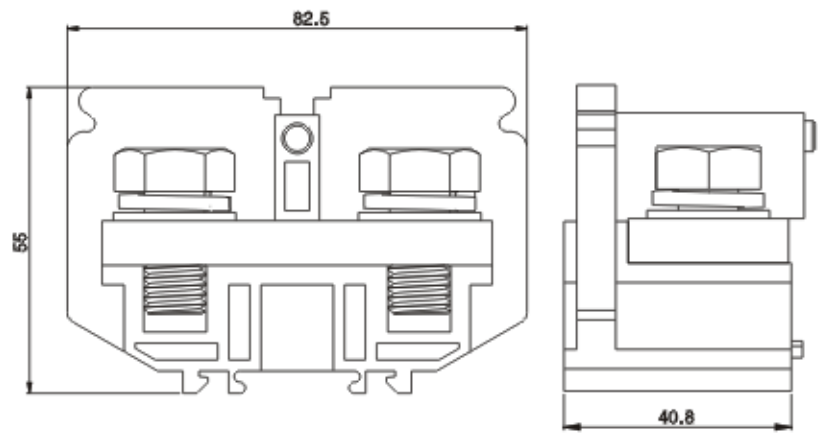
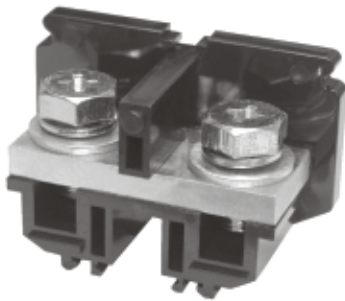

KTB3 系列

KTB3-015(2段)

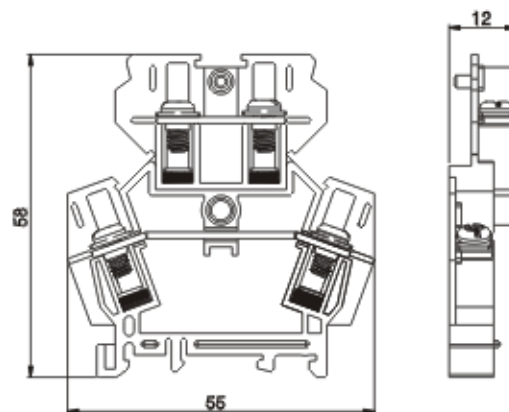
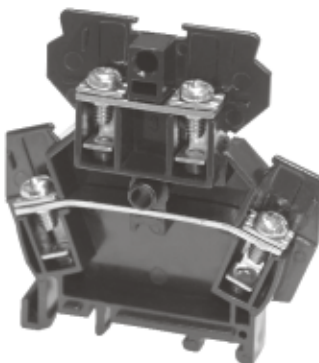

产品性能 Specification

- 基座材料采用阻燃聚碳酸酯、耐热性、硬度及电气绝缘性能良好。
- 连接片采用通电性能良好的1级黄铜，持久性防腐蚀的表面处理有助于在长期使用下持续通电与维持较好的表面。
- 充分的电流容量和螺丝的精密加工巩固产品装配。
- 提供10A至300A不等的多样化容量和极数。
- 导轨上可连接装配基座及侧盖、固定架。
- KTB3-015的产品为双层式，可执行双层接线连接。

一般性能 General Specification

区分	规格	KTB2-010	KTB2-015	KTB2-025	KTB2-035	KTB2-60	KTB2-100	KTB2-200	KTB2-300	KTB3-015
额定电流 Ampere		10A	15A	25A	35A	60A	100A	200A	300A	15A
绝缘电压 U_i		600VAC								
绝缘电阻 Insulation Resistance		100M Ω 以上 500VDC								
介质耐压 Dielectric Strength		2,500VAC 1分钟								
材质 Material	基座 Body	阻燃聚碳酸酯(黑色)								
	盖子 Cover	阻燃聚碳酸酯								
	端子 Terminal	H62黄铜								
	标示条 Name Pad	PVC								

连接端子样式

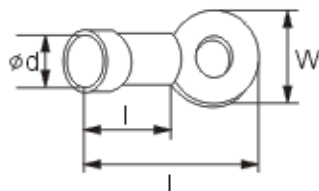

区分	规格	KTB2-010	KTB2-015	KTB2-025	KTB2-035	KTB2-60	KTB2-100	KTB2-200	KTB2-300	KTB3-015
端子螺丝 Terminal Bolt		M3.0	M3.5	M4.0		M6.0	M8.0	M10.0	M12.0	M3.5
W(mm)		6.6	6.8	8.7	9.6	12.4	16.5	24.5	29.0	6.8
L(mm)		20.0	20.0	27.0	27.0	30.0	45.5		55.5	20.0
l(mm)		8.0	8.0	14.0		14.5	20.5	20.5	25.5	8.0
d		ϕ 3.1	ϕ 3.6	ϕ 4.1		ϕ 6.1		ϕ 10.1	ϕ 12.1	ϕ 3.6

※ 如因提高质量而进行产品更改，恕不另行通知。

All right reserved. Specification subject to change without notice.

■ 附件选项 Option

导轨 Channel

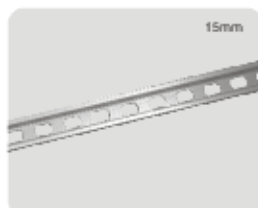

KTB2-CHA(10A用)
KTB2-CHA-2m

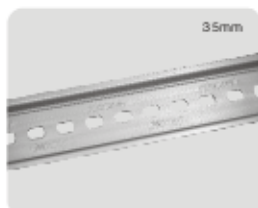

KTB2-CHB(15A以上)
KTB2-CHB-2m

侧盖 Separator



KTB2-A10~A300



KTB3-A15

固定架 Stopper



KTB2-STA(15mm用)



KTB2-STB(35mm用)

防尘盖 Cover



KTB2-CVA(10A用)



KTB2-CVB(15~35A用)
KTB2-CVC(60~100A用)
KTB2-CVD(200A用)
KTB2-CVE(300A用)



KTB2-STC(塑料)

标示条 Name Pad



KTB2-PA(10A用)
KTB2-PB

短路片 Short Bar

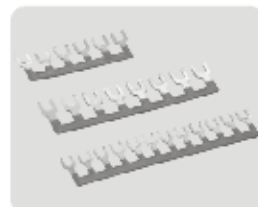

KTB2-S1512□
KTB2-S2506□
KTB2-S3508□

□颜色: B-蓝色, K-黑色
R-红色, Y-黄色

■ 附件适用一览表

区分	规格	KTB2-010	KTB2-015	KTB2-025	KTB2-035	KTB2-60	KTB2-100	KTB2-200	KTB2-300	KTB3-015
导轨 Channel	KTB2-CHA	KTB2-CHB								KTB2-CHB
侧盖 Separator	KTB2-A10	KTB2-A15/A25		KTB2-A35	KTB2-A60	KTB2-A100	KTB2-A200	KTB2-A300	KTB3-A15	
固定架 Stopper	KTB2-STA	KTB2-STB								KTB2-STB
防尘盖 Cover	KTB2-CVA	KTB2-CVB			KTB2-CVC		KTB2-CVD (订做产品)	KTB2-CVE (订做产品)	KTB2-CVB	
标示条 Name Pad	KTB2-PA	KTB2-PB								KTB2-PB
短路片 Short Bar		KTB2-S1512	KTB2-S2506	KTB2-S3508						