

➤ **Linear Output Type Light Sensor**



- Features:** Compact moisture resistant package
- Lowest "on" resistance
- Low distortion
- Ideal for Hi-Fi stereo applications

Storage Temperature: -30 to+70°C
Operating Temperature: -30 to+70°C
Soldering Temperature: 260°C<10s
Isolation Voltage(peak): 2000V

Symbol	Parameter	Min	Typ	Max	Units	TestConditions
LED						
IF	Forward Current			40	mA	(Derate Linearly to 0 at 75°C)
VF	Forward Voltage			2.0	V	IF = 16 mA
IR	Reverse Current			100	µA	VR=3.8V
Cell						
VC	Maximum Voltage			60	V	(Peak AC or DC)
PD	Power Dissipation			50	mW	(Derate Linearly to 0 at 75°C)
Coupled						
RON	On Resistance		1.0		KΩ	IF = 1.0mA**
ROFF	Off Resistance		5.0		MΩ	10sec after IF=0.38Vdc on cell
TR	Rise Time		10		msec	Time to 63% of final conductance @ IF = 16 mA ***
TF	Decay Time		800		msec	Time to 100KΩ after removal of input @ IF = 16 mA
	Cell Temp Coefficient		1.0		%°C	IF >5 mA

NOTE:

- * >2mm from case for < 5 sec
- ** measured after a dark history of 1 week
- *** Rise time is the time for the dark to light change in conductance to reach 63% of its final value

Output Resistance vs. Forward Current

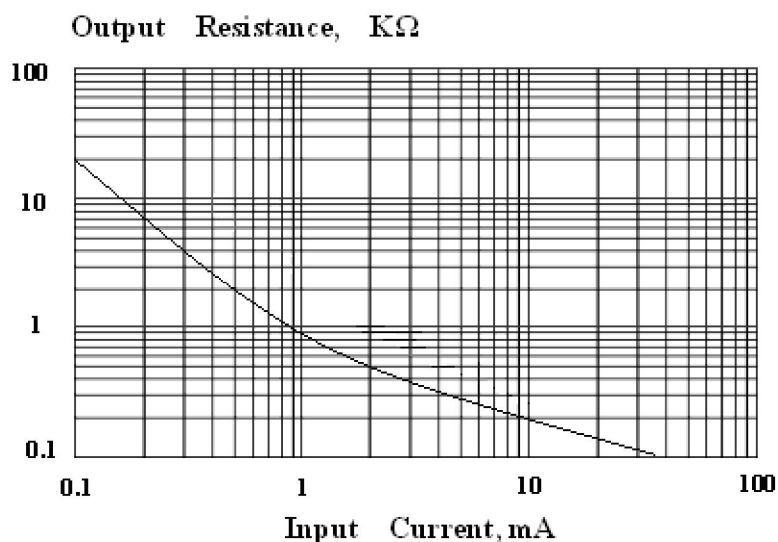

LED Forward Current vs. Forward Voltage

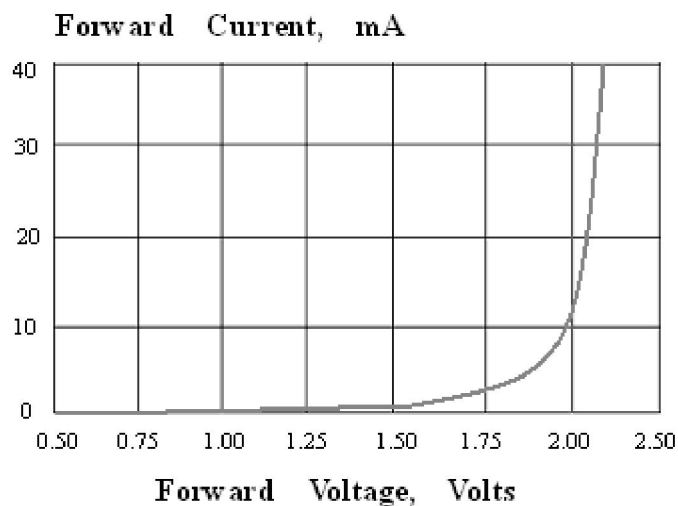

Output Resistance vs. Temperature

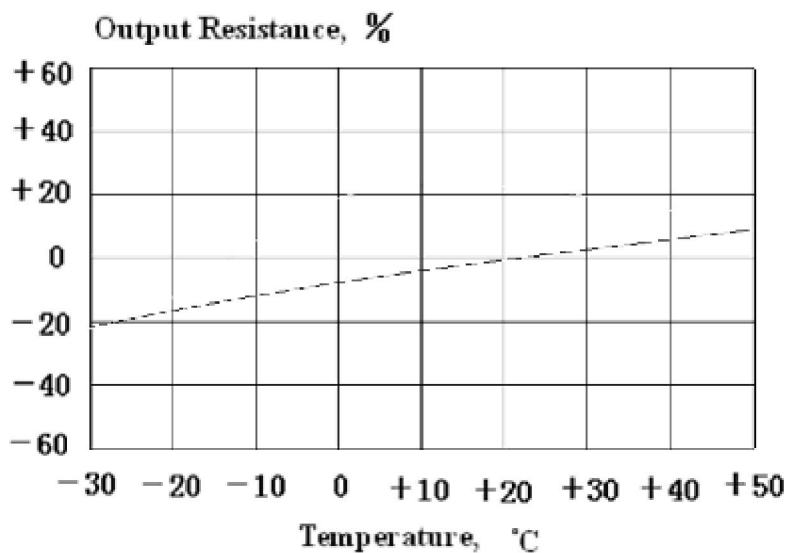

Rise/Fall Time vs. Load Resistance

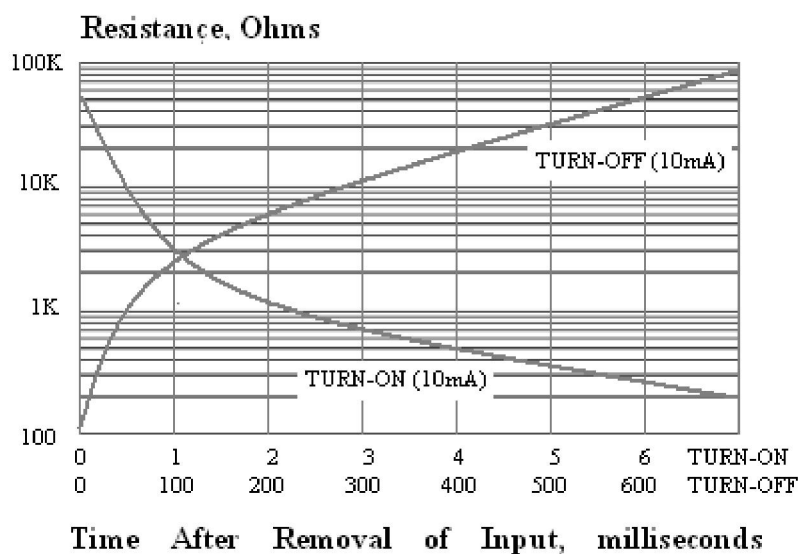

Dimensional Outline and Pin Connection (Unit:mm)

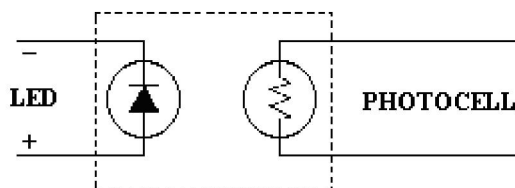
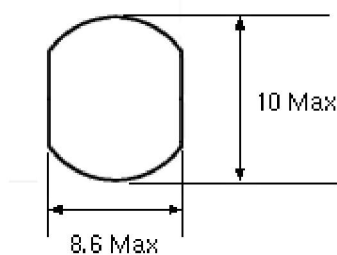
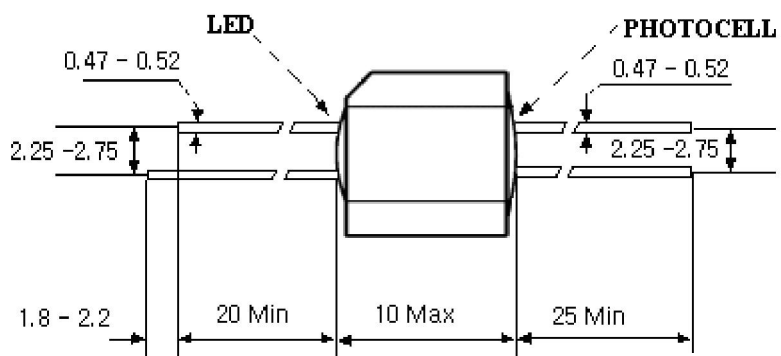

型号: MI12-4

深圳市安富新电子有限公司

品牌: MACRON