



965 Series Relay

FEATURES

- Single and double contact types are offered, and 15A switching capacity relay is used exclusive in automobile control switching box.
- Nominal power 1100mW.
- Operating power 400mW and 535mW



CONTACT RATINGS

- Contact Arrangement1 Form A(SPST-NO)
1 Form B(SPST-NC)
1 Form C(SPDT)
1 Form U (SPST-DM)
1 Form V (SPST-DB)
1 Form W (SPDT-DM-DB)

● Max. Switching Power

1 Form A	210W
1 Form B	140W
1 Form C	210W
1 Form U	140W
1 Form V	105W
1 Form W	140W

● Max. Switching Voltage.....14VDC

● Max. Switching Current

1Form A	15A
1Form C	15A
1 Form B	10A
1 Form U	2×10A
1 Form V	2×7.5A
1 Form W	2×10A

● Contact Resistance.....≤100mΩ

● Rating Load

1 Form A	15A/14VDC
1 Form B	10A/14VDC
1 Form C	NO: 15A/14VDC NC: 10A/14VDC
1 Form U	2×10A /14VDC
1 Form V	2×7.5A /14VDC
1 Form W	NO: 2×10A /14VDC NC: 2×7.5A/14VDC

● Contact Material

.....Ag Alloy

965 Referential Data

Timing

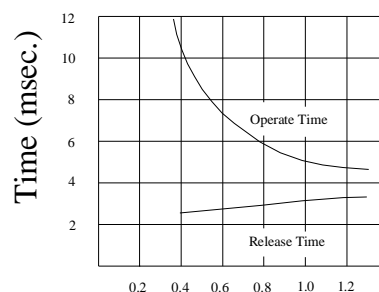

Coil Temperature Rise

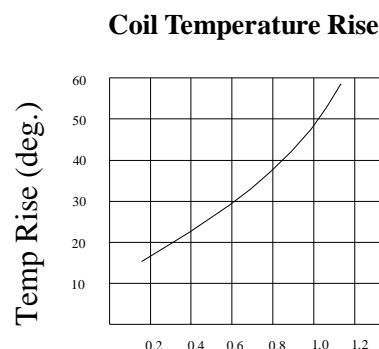

Coil Power (W)

Life Curves

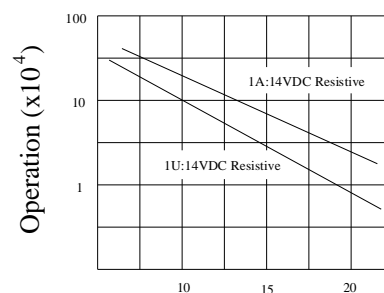

Contact Current (A)

CHARACTERISTICS

- Electrical Life..... 1×10^5
- Mechanical Life..... 1×10^7
- Initial Insulation Resistance.....Min. 100M Ω 500VDC
- Contact Resistance (Initial)..... $\leq 100\text{m}\Omega$
- Operate Time..... $\leq 6\text{ms}$
- Release Time..... $\leq 3\text{ms}$
- Initial Dielectric Strength
 -50/60Hz 750VAC 1 min. (between open contacts)
 -50/60Hz 500VAC 1 min. (between contacts and coil)
- Vibration Resistance
 -Malfunction: 10 to 55Hz at Double Amplitude of 1.5mm
 -Destructive: 10 to 55Hz at Double Amplitude of 1.5mm
- Shock Resistance.....Malfunction: 10G (11ms) / Destructive: 100G(6ms)
- Ambient Temperature..... $-40^\circ\text{C} \sim +85^\circ\text{C}$
- Relative Humidity.....85% at 40°C
- Unit Weight.....Approx. 20g

ORDERING INFORMATION

965 T - 1C- 12 D S
 1 2 3 4 5 6

Enclosure.....Nil = Open Type
S = Sealed Type

Coil Type.....D: DC

Coil Voltage.....6~24V

Contact Arrangement.....1A = 1 Form A (SPST-NO)
1B = 1 Form B (SPST-NC)
1C = 1 Form C (SPDT)
1U = 1 Form U (SPST-DM)
1V = 1 Form V (SPST-DB)
1W = 1 Form W (SPDT-DM-DB)

Optional.....Nil = General Type
T = Twin Relay with Length Cover

Model Number.....965

COIL RATINGS (at 20°C)

COIL TYPE	Coil Nominal Voltage (V)	Coil Resistance ($\Omega \pm 10\%$)	Pick-Up Voltage (V) \leq	Drop-Out Voltage (V) \geq	Nominal Current (mA)
DC Standard Coils	6	33	3.6	0.6	182
	12	130	7.2	1.2	92
	24	520	14.4	2.4	46

* Max Continuous Voltage at 20°C: 110% of Coil Nominal Voltage.

OUTLINE DIMENSIONS

General Type

Dimensions

Drilling Plan (Bottom View)

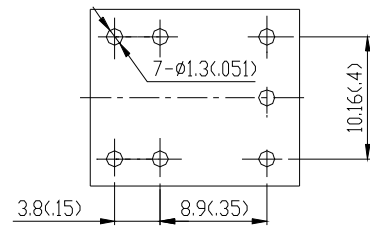
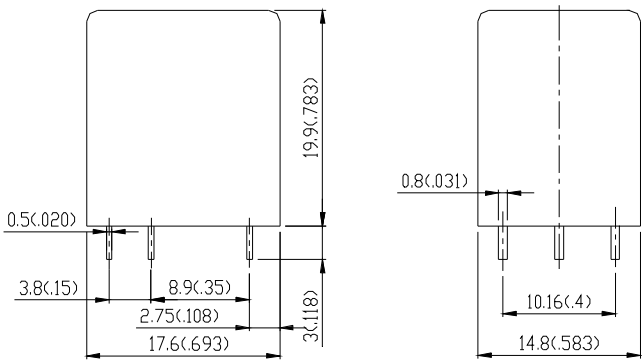
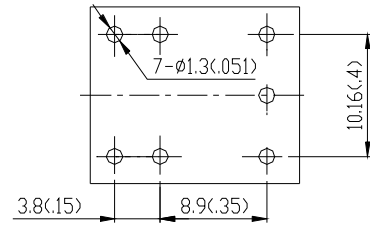
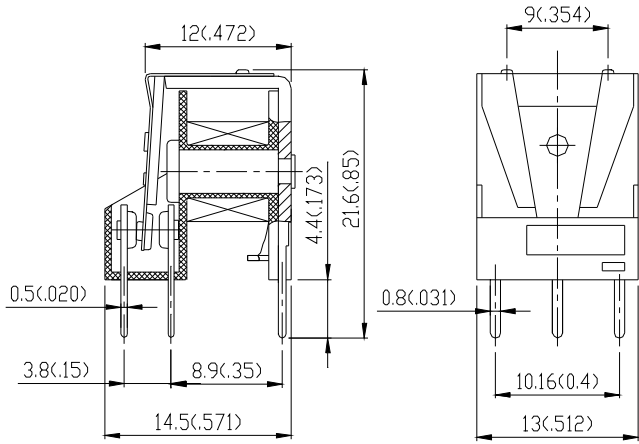

Internal Connections (Bottom View)

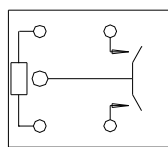

1U (SPST-DM)

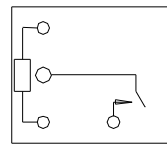

1A (SPST-NO)

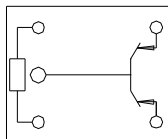

1V (SPST-DB)

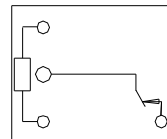

1B (SPST-NC)

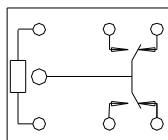

1W (SPDT-DM-DB)

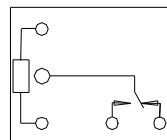

1C (SPDT)

Twin Relay with Length Cover

Dimensions

Drilling Plan (Bottom View)

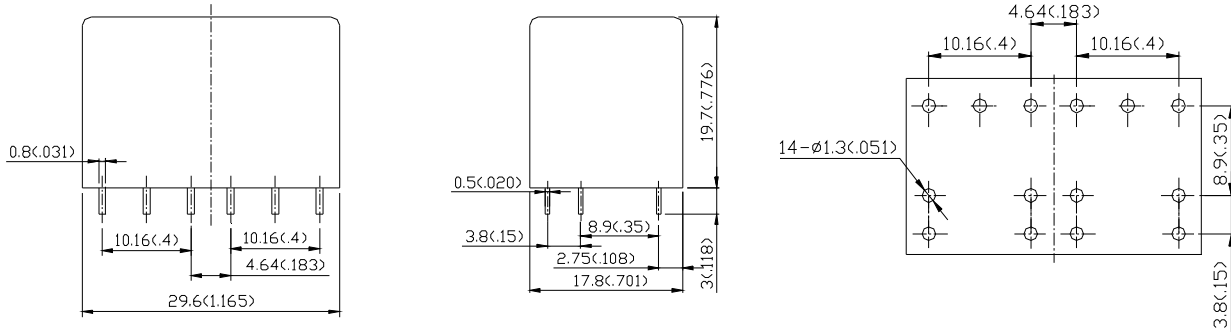

Internal Connections (Bottom View)

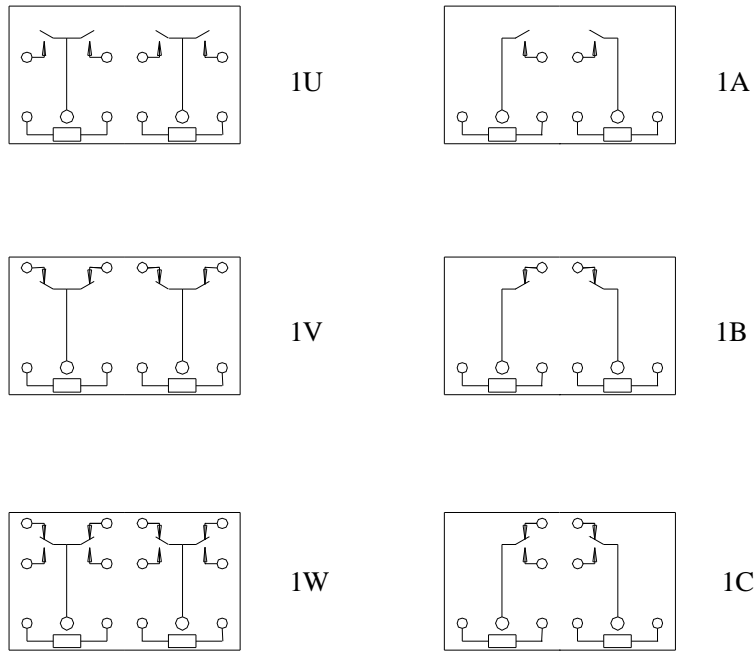

REMARK: Tolerance of outline dimensions: $\pm 0.2(.008)$.

UNIT: mm (inch)