

GP/ML/TR series

10 Amp Control Relay Non-latching, Latching & Timing Versions

File E15631

File LR29186

Users should thoroughly review the technical data before selecting a product part number. It is recommended that users also seek out the pertinent approvals files of the agencies/laboratories and review them to ensure the product meets the requirements for a given application.

GP/ML/TR Design Features

Among the advances AGASTAT control relays offer over existing designs is a unique contact operating mechanism. An articulated arm assembly amplifies the movement of the solenoid core, allowing the use of a short stroke coil to produce an extremely wide contact gap. The long support arms used in conventional relays are eliminated. Both current capacity and shock/vibration tolerance are greatly increased, as well as life expectancy.

Design/Construction

AGASTAT control relays are operated by a moving core electromagnet whose main gap is at the center of the coil. A shoe is fitted to the core which overlaps the yoke and further increases the magnetic attraction.

The coil itself is in the form of an elongated cylinder, which provides a low mean turn length and also assists heat dissipation. Since the maximum travel of the electromagnet does not provide optimum contacts movement, an ingenious amplifying device has been designed.

This consists of a W-shaped mechanism, shown in figure 1. When the center of the W is moved vertically the lower extremities move closer to each other as can be seen in the illustration. The center of the W mechanism is connected to the moving core of the electromagnet and the two lower points are connected to the moving contacts.

Two of these mechanisms are placed side-by-side to actuate the four contacts sets of the relay. The outer arms of the W mechanisms are leaf springs, manufactured from a flat piece of non-ferrous metal. These outer arms act as return springs for their corresponding contacts. This provides each contact with its own separate return spring, making the contacts independent.

The mechanical amplification of the motion of the electromagnet permits a greater distance between the contacts, while the high efficiency of the electromagnet provides a nominal contact force in excess of 100 grams on the normally open contacts.

All the contacts are positioned well away from the cover and are well ventilated and separated from each other by insulating walls.

The absence of metal-to-metal friction, the symmetrical design of the contact arrangement and the lack of heavy impacts provides a mechanical life of 100,000,000 operations.

For use in AC circuits, the relay is supplied with a built-in rectification circuit, thus retaining the high DC efficiency of the electromagnet. The current peak on energizing is also eliminated and consequently the relay can operate with a resistance in series (e.g. for high voltages or for drop-out by shorting the coil). The use of the rectification circuit offers still other advantages. The same model can operate at frequencies ranging from 40 to 400 cycles. Operation of the relay is crisp; even with a low AC voltage, there is a complete absence of hum and vibration.

The plastic dust cover has two windows through which the iron yoke protrudes to facilitate cooling and also to allow direct mounting arrangement of the relay irrespective of the terminals.

Figure 1 – Illustration of Amplification

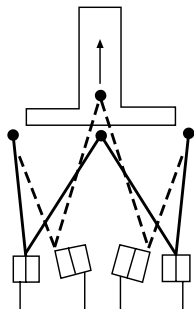

This diagram illustrates amplification obtained by the articulated operating mechanism.

NOTE: Seismic & radiation tested EGP, EML and ETR models are available. Consult factory for detailed information.

Features

- Occupies very small panel space
- May be mounted singly, in continuous rows or in groups.
- Available with screw terminal molded socket.
- 4 SPDT contacts.
- Magnetic blowout device option increases DC current carrying ability approximately ten times for both N.O. and N.C. contacts. In both AC and DC operation, the addition of the device will normally double the contact life, due to reduced arcing.

GP/ML Contact Data @ 25°C

Arrangements: 4 Form C (4PDT)

Material: Silver plated.

Ratings: See chart.

Expected Life: Mechanical: 100 million operations.
Electrical: See chart and graph.

Contact Ratings and Expected Life

Voltage	Current (Amps)	Power Factor or Time Constant	Number of Electrical Operations	Remarks
540 VAC	3	COS Ø = 0.5	15,000	2 contacts in series
380 VAC	15	Resistive	10,000	2 contacts in parallel
380 VAC	10	Resistive	200,000	
380 VAC	3 x 3.3	COS Ø = 0.8	200,000	3hp motor
220 VAC	20	Resistive	20,000	2 contacts in parallel
220 VAC	15	COS Ø = 0.5	20,000	2 contacts in parallel
220 VAC	10	Resistive	400,000	
220 VAC	3 x 6	COS Ø = 0.8	200,000	3hp motor
220 VAC	5		1,500,000	Filament lamps
220 VAC	5	Resistive	3,000,000	
220 VAC	2.5	COS Ø = 0.25	2,000,000	
220 VAC	2	Resistive	15,000,000	
220 VAC	1.25	Resistive	30,000,000	
120 VDC	1.5	Resistive	20,000,000	with blow-out device
48 VDC	10	Resistive	1,000,000	

Load Life Curve

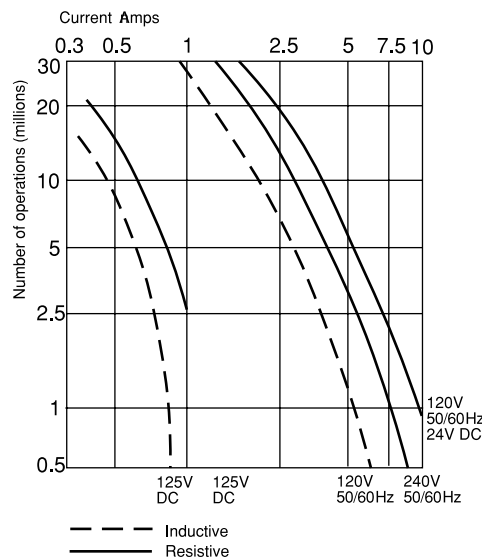

Initial Dielectric Strength

Between non-connected terminals: 2,000V rms, 60 Hz.
Between non-connected terminals & relay yoke: 2,000V rms, 60 Hz.

Initial Insulation Resistance

Between non-connected terminals: 10⁹ ohms at 500VDC.
Between non-connected terminals & relay yoke: 10⁹ ohms at 500VDC.

Coil Data

Voltage: 24, 120 & 220VAC, 60 Hz. Add series resistor for 380-440VDC; 12, 24, 48, 125 & 250VDC.

Duty Cycle: Continuous.
Nominal Coil Power: 6VA for AC coils; 6W for DC coils.
There is no surge current during operation.

Coil Operating Voltage

	DC					AC, 50/60Hz		
Nominal Coil Voltage	12	24	48	125	250	24	120	220
Minimum Pick-up Voltage at 20°C	9	18	36	94	187	19	92	175
Minimum Pick-up Voltage at 40°C	9.5	19	38	100	200	20	102	188
Maximum voltage for continuous use	13.5	27	53	143	275	27	137	245

For 380VAC – Use 6800 ohms 4 watt resistor in series with 220VAC relay.
For 440VAC – Use 8200 ohms 6 watt resistor in series with 220VAC relay.

Drop-out voltage is between 10% and 40% of the nominal voltages for both DC and AC (For example: in a 120 VAC unit, drop-out will occur between 12 and 48 volts.) DC relays will function & with unfiltered DC from a full-wave bridge rectifier.

Operate Data @ 20°C

Operate Time at Rated Voltage: Between energizing and opening of normally closed contacts, less than 18 milliseconds on AC and less than 15 milliseconds on DC.

Release Time: Between energizing and closing of normally open contacts, less than 35 milliseconds on AC and less than 30 milliseconds on DC. Between de-energizing and opening of normally open contacts, less than 70 milliseconds on AC and less than 8 milliseconds on DC. Between de-energizing and closing of normally closed contacts, less than 85 milliseconds on AC and less than 25 milliseconds on DC.

Environmental Data

Operating Temperature Range: 0°C to +60°C.

Vibration: Single axis fragility curve data are available on request at frequencies from 5 Hz. to 33 Hz.

Shock: The relay, when kept energized by means of one of its own contact sets, will withstand 40g shock load when operating on DC, and 150g shock load on AC.

Mechanical Data

Mounting Terminals: 16 flat base pins. Screw terminal sockets are available.

Wire Connection: The 16 flat pins are arranged in four symmetrical rows of four pins; the pitch in both directions being .394". Connection may be made to the relay by soldering. Sockets are available with screw terminals.

The internal wiring of the relay is also symmetrical as shown in the adjacent figure, allowing the relay to be inserted into the socket in either of two positions. Terminals B2 and B3 are provided as extra connections for special applications.

Weight: 10.9 oz. (308g) approximately.

Ordering Information

Typical Part No. ➤

GP

I

N

1. Basic Series:

GP = Non-latching Control Relay ML = Magnetic Latching Control Relay

2. Coil Voltage:

A = 12VDC G = 24VAC, 60 Hz.
B = 24VDC I = 120VAC, 60 Hz.
C = 48VDC J = 220VAC, 60 Hz.
D = 125VDC
F = 250VDC

3. Options:

N = Magnetic Blow-out Device
Q = Light to indicate coil energization (GP only. 120VAC, 125VDC, 220VAC and 250VDC voltages only.)
R = Internal diode to suppress coil de-energization transient. (GP only. When used on DC unit, relay release time increases to same value as AC unit).

Our authorized distributors are more likely to maintain the following items in stock for immediate delivery..

GPD
GPDN

Outline Dimensions

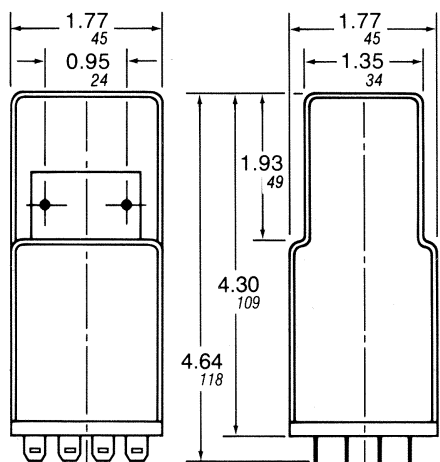

Dimensions are shown for reference purposes only.

Dimensions are in inches over (millimeters) unless otherwise specified.

Wiring Diagrams (Bottom Views)

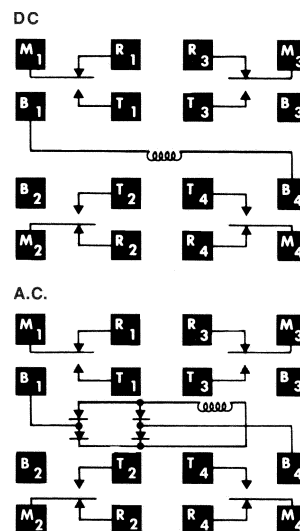

Specifications and availability subject to change.

www.tycoelectronics.com
Technical support:
Refer to inside back cover.

TR series

10 Amp Control Relay – Timing Version

TR Features

- 8 timing ranges.
- 4 SPDT contacts.
- Magnetic blowout device option increases DC current carrying ability approximately ten times for both N.O. and N.C. contacts. In both AC and DC operation, the addition of the device will normally double the contact life, due to reduced arcing.

TR Design/Construction

Couples an advanced electromechanical design with a field-proven solid-state timing network, an adaptation of the circuit used in the AGASTAT premium grade SSC Timer.

This unique circuit also eliminates the need for supplementary temperature-compensation components, affording unusual stability over a realistically broad operating temperature range. It also provides transient protection and protection against premature switching of the output contacts due to power interruption during timing.

Timing Specifications

Operating Mode: On-Delay (Delay on energization).

Timing Adjustment: Internal fixed or internal potentiometer.

Timing Ranges:	.15 to 3 sec.	4 to 120 sec.
	.55 to 15 sec.	10 to 300 sec.
	1 to 30 sec.	1 to 30 min.
	2 to 60 sec.	2 to 60 min.

Accuracy:

Repeat: ±2% as fixed temperature and voltage.

Overall: ±5% over combined rated extremes of temperature and voltage.

Reset Time: 75ms.

Contact Data @ 25°C

Arrangements: 4 Form C (4PDT)

Nominal Rating: 10A @ 120VAC.

Contact Pressure:

Between movable and normally closed contacts: 30 g, typical.

Between movable and normally open contacts: 100 g, typical.

Expected Life: Mechanical: 100 million operations.

Electrical: See load/life graph.

Initial Dielectric Strength

Between terminals and case and between mutually-isolated contacts: 2,000VAC.

Ordering Information

Typical Part No. >

TR 1 4 B 1 A N

1. Basic Series:

TR = Timing control relay

2. Operation:

1 = On-delay

3. Output:

4 = 4PDT (4 form C)

4. Operating Voltage:

B = 24VDC D = 215VDC I = 120VAC, 50/60 Hz.

5. Timing Adjustment:

1 = Internal fixed. 3 = Internal potentiometer.

6. Timing Range:

A = .15 to 3 sec. C = 1 to 30 sec. E = 4 to 120 sec. I = 2 to 60 min.
B = .55 to 15 sec. D = 2 to 60 sec. G = 10 to 300 sec. N = 1 to 30 min.

7. Options:

N = Magnetic blow-out device.

Load Life Curve

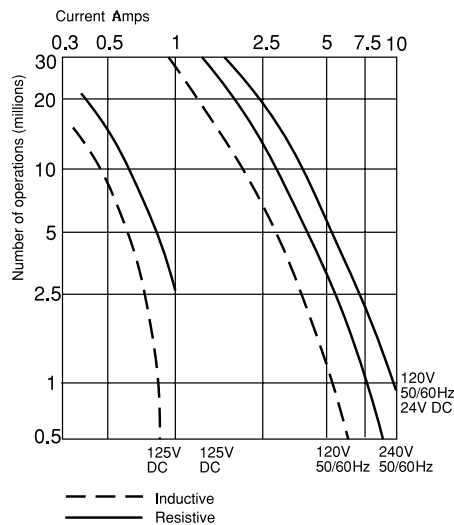

Initial Insulation Resistance

Between non-connected terminals: 10⁹ ohms at 500VDC.

Between non-connected terminals & relay yoke: 10⁹ ohms at 500VDC.

Coil Data

Voltage: 120VAC, 50-60 Hz.; 24 & 125VDC.

Transient Protection

1,500 volt transient of less than 100 microseconds, or 1,000 volts or less.

Environmental Data

Operating Temperature Range: 0°C to +50°C.

Mechanical Data

Mounting Terminals: 16 flat base pins. Screw terminal sockets are available.

Weight: 11 oz. (311g) approximately.

Wiring Diagram (Bottom View)

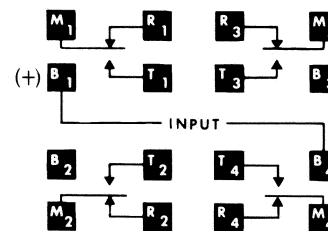

Outline Dimensions

Same as GP/MR. See previous page.

Our authorized distributors are more likely to maintain the following items in stock for immediate delivery..

None at present.

Accessories for GP/ML/TR series control relays

Front connected sockets

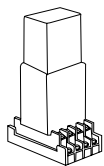

Cat. No. CR0001
With captive clamp terminals

Cat. No. CR0002
With (#6) binding head screws

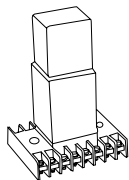
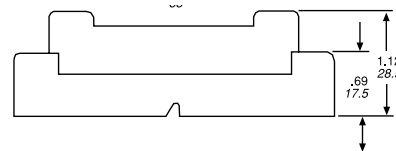
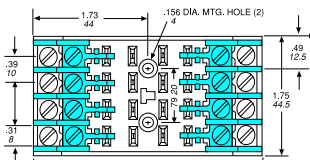

Cat. No. CR0095
With (#6) screw terminals

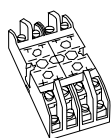
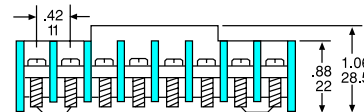
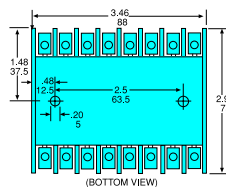

Cat. No. CR0067
With (#6) screw terminals

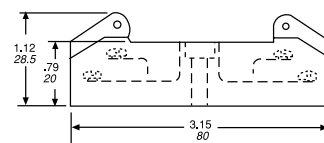
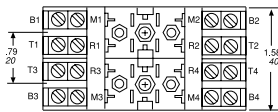

Hold down (locking) springs

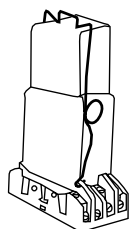

Cat. No. CR0069
For socket: CR0067

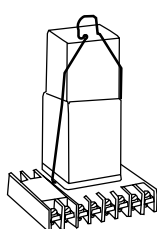
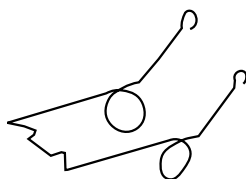

Cat. No. CR0070
For socket: CR0095

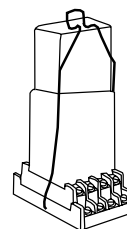

Cat. No. CR0111
For sockets: CR0001 & CR0002



Heavy-duty hold down (locking) straps

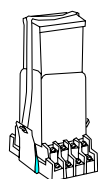

***Cat. No. CR0133**
For socket: CR0001 & CR0002

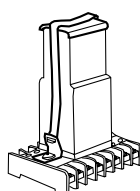

***Cat. No. CR0155**
For socket: CR0095

* Catalog number includes strap, strap plate and necessary brackets.

Magnetic blowout device

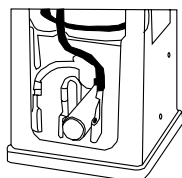

Cat. No. CR0190
Reduces arcing on the relay contacts when they make or break contact, either upon energizing or de-energizing, resulting in less contact degradation. Extends the life of the contact.

Extracting handle

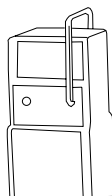

Cat. No. CR0179
Used to remove GP, ML and TR units from mounting bases.