

AC Filter for PCB Mounting

Standard- or Medical-Filter



Shield



**Description**

- Component: PCB Mounting
- 1 Function: Line filter in standard and medical version
- For PCB mounting

**Approvals**

- VDE License Number: 101307
- UL License Number: E72928
- CSA License Number: 97784

**Characteristics**

- Ultra-compact design
- Shield available separately (German silver)
- Qualified for use in equipment according IEC/EN 60950

**References**

[General Product Information](#)

**Weblinks**

[Approvals](#), [RoHS](#), [CHINA-RoHS](#), [Mating Connectors](#), [e-Store](#), [Distributor-Stock-Check](#), [Accessories](#)

**Technical Data**

|                           |   |
|---------------------------|---|
| Ratings IEC               | 1 - 10A @ Ta 40 °C / 250 VAC; 50Hz  |
| Ratings UL/CSA            | 1 - 10A @ Ta 40 °C / 125 VAC; 60Hz  |
| Leakage Current           | standard < 0.5 mA (250 V / 60Hz)<br>medical < 5 µA (250 V / 60 Hz)          |
| Dielectric Strength       | > 1.7 kVDC between L-N<br>> 2.7 kVDC between L/N-PE<br>Test voltage (2 sec) |
| Allowable Operation Temp. | -25 °C to 85 °C   |
| Climatic Category         | 25/085/21 acc. to IEC 60068-1   |
| Degree of Protection      | from front side IP 40 acc. to IEC 60529                                     |
| Protection Class          | Suitable for appliances with protection class 1 acc. to IEC 61140           |
| Terminal                  | For PCB mounting  |
| Material: Housing         | Thermoplastic, UL 94V-0   |

|             |   |
|-------------|---|
| Line Filter | Standard and Medical Version, IEC 60939, IEC 60601-1, UL 1283, UL 544, EN 133 200, CSA C22.2 no. 8<br><a href="#">Technical details</a> |
| MTBF        | > 5'900'000h acc. to MIL-HB-217 F   |

**Dimensions**

Line Filter

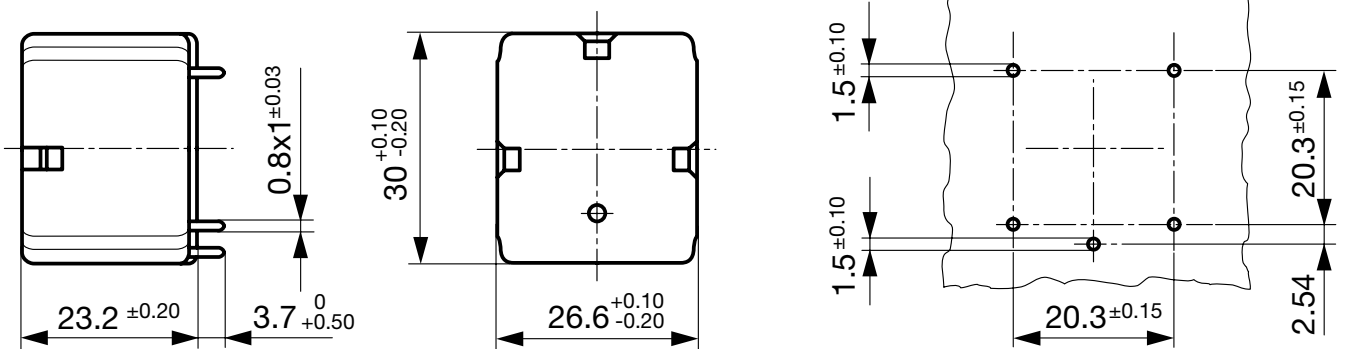
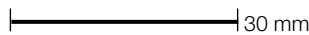

Shield

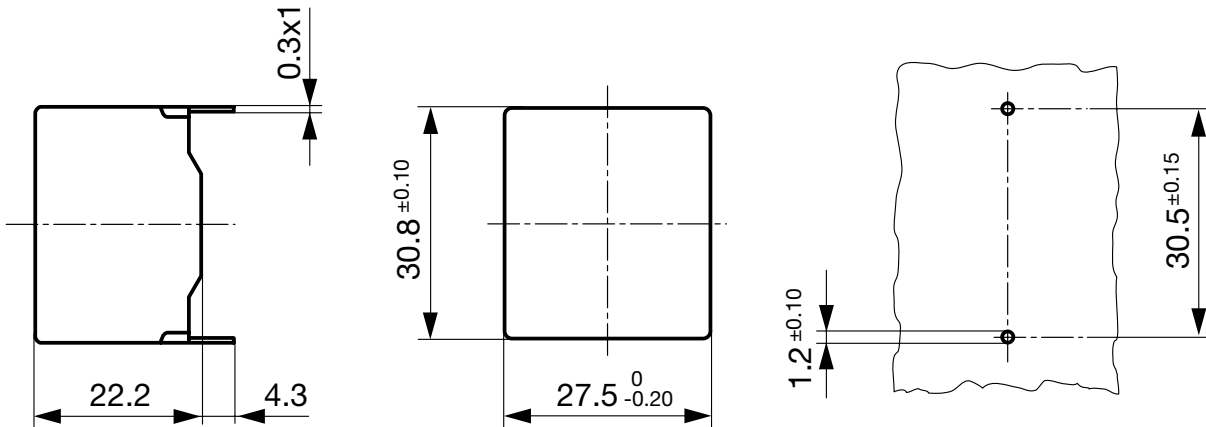

### Technical Data of Filter-Components

| Rated Current [A] | Filter-Type          | Inductances L [mH] | Capacitance CX [nF] | Capacitance CY [nF] | R [MΩ] |
|-------------------|----------------------|--------------------|---------------------|---------------------|--------|
| 1                 | Standard Version     | 2 x 11             | 47                  | 2.2                 | -      |
| 2                 | Standard Version     | 2 x 4              | 47                  | 2.2                 | -      |
| 4                 | Standard Version     | 2 x 1.6            | 47                  | 2.2                 | -      |
| 6                 | Standard Version     | 2 x 0.7            | 47                  | 2.2                 | -      |
| 10                | Standard Version     | 2 x 0.3            | 47                  | 2.2                 | -      |
| 1                 | Medical Version (M5) | 2 x 11             | 47                  | -                   | 1      |
| 2                 | Medical Version (M5) | 2 x 4              | 47                  | -                   | 1      |
| 4                 | Medical Version (M5) | 2 x 1.6            | 47                  | -                   | 1      |
| 6                 | Medical Version (M5) | 2 x 0.7            | 47                  | -                   | 1      |
| 8                 | Medical Version (M5) | 2 x 0.5            | 47                  | -                   | 1      |
| 10                | Medical Version (M5) | 2 x 0.3            | 47                  | -                   | 1      |

### Diagrams

Standard version

Medical version

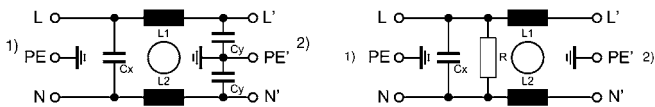

1) Line  
2) Load

1) Line  
2) Load

**Attenuation Loss**

--- differential mode \_\_\_\_ common mode

Standard version

1 A

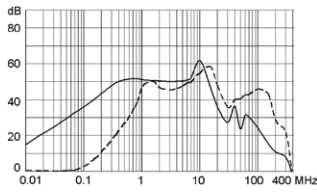

2 A

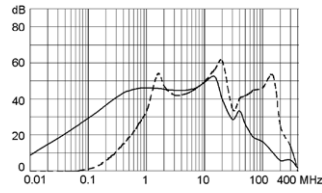

4 A

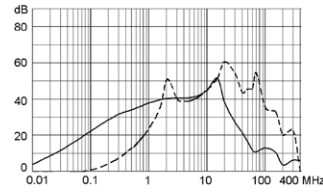

6 A

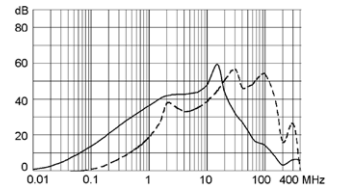

8 A

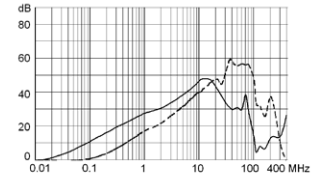

10 A

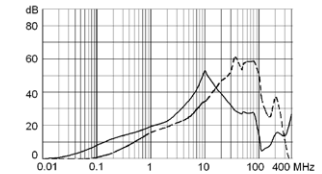

Medical version (M5)

1 A

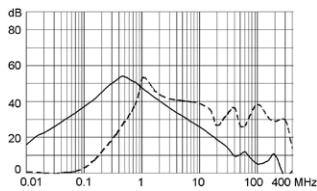

2 A

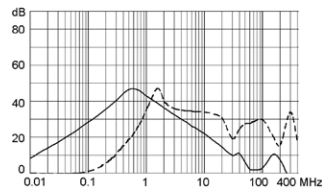

4 A

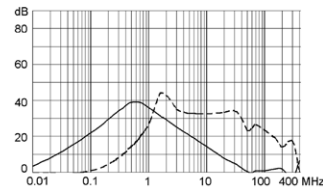

6 A

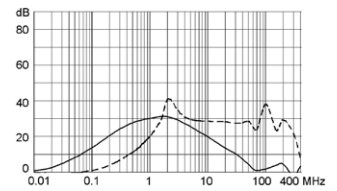

8 A

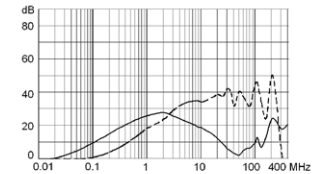

10 A

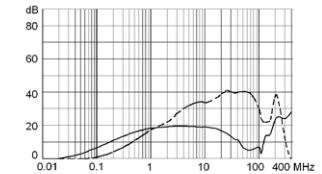

**Variants**

| Rated Current [A] | Filter-Type          | EMC-Shielding      | Weight [g] | Order Number |
|-------------------|----------------------|--------------------|------------|--------------|
| -                 | -                    | Shield             | 20         | 5500.0001    |
| 1                 | Standard Version     | Without EMC-shield | 35         | 5500.0155.1  |
| 2                 | Standard Version     | Without EMC-shield | 35         | 5500.0255.1  |
| 4                 | Standard Version     | Without EMC-shield | 35         | 5500.0455.1  |
| 6                 | Standard Version     | Without EMC-shield | 35         | 5500.0655.1  |
| 10                | Standard Version     | Without EMC-shield | 35         | 5500.1055.1  |
| 1                 | Medical Version (M5) | Without EMC-shield | 35         | 5500.0155.3  |
| 2                 | Medical Version (M5) | Without EMC-shield | 35         | 5500.0255.3  |
| 4                 | Medical Version (M5) | Without EMC-shield | 35         | 5500.0455.3  |
| 6                 | Medical Version (M5) | Without EMC-shield | 35         | 5500.0655.3  |
| 8                 | Medical Version (M5) | Without EMC-shield | 35         | 5500.0855.3  |
| 10                | Medical Version (M5) | Without EMC-shield | 35         | 5500.1055.3  |

**Packaging unit** 100 Pcs