



FORTE BATTERY

LITHIUM BATTERY TYPE:CR26500

锂电池 | 型号: CR26500

Key Characteristics 优点及特征

High and stable operating voltage

工作电压平稳, 在绝大多数应用的寿命期内具有高而稳定的电压响应

Low self-discharge rate(less than 3% after 1 year storage at 25°C)

低自放电率 (在+25°C的条件下贮存, 年自放电率低于3%)

Operating temperature (-40°C~+60°C)

工作温度 (-40°C~+60°C)

Hermetically glass-to-metal sealing

气密的玻璃封口金属外盖

Nickel-plated steel container

镀镍低碳钢外壳和电极帽

Organic electrolyte

有机电解液

Spiral type

卷绕式结构

UL (MH46528)、CE、SGS recognized

已通过UL (MH46528)、CE、SGS 认证

ISO9001:2008 approved

通过 ISO9001:2008 质量管理体系认证

AIG Insurance

已购买美国AIG 产品责任险

Warning 警告

Fire, explosion and severe burn hazard.

- 请将电池远离明火, 易燃易爆物品;

Do not recharge, crush, disassemble, heat, above 212°F (100°C), incinerate, short circuit or expose contents to water;

- 请勿将电池充电、短路、碾碎、拆解;

Do not reverse the positive and negative pole of battery while using it;

- 严禁新旧电池或不同类型电池混合使用;

Do not solder directly on the battery;

- 严禁电池正、负极直接焊接; 严禁电池正、负极反装;

Dispose of used batteries promptly.

- 使用后的电池请合理处理。

Characteristics 性能数据

Nominal capacity(10mA-2.0v).....5400mAh
标称容量

Nominal voltage.....3.0v
额定电压

Max.constant current.....2000mA
最大连续工作电流

Max.pulse current.....3000mA
最大脉冲电流

Weight.....62g
电池重量

Volume.....Φ26.0X50.0mm
电池尺寸

Workable temperature.....-40°C~+60°C
工作温度



Main applications 主要应用领域

Utility meters (electricity meters, water meters, gas meters, AMR)

公用事业计量仪表, 电表、水表、气表、热表等

Security systems (door lockers, smoke alarm sensors detectors) 报警和安全装置

CMOS memory and RTC backup
记忆存储备份

Vehicle tracking
跟踪系统

Industrial clocks
电子时钟

Sea buoys、remote monitoring systems、industrial clocks
浮标及远程监控系统

Military electronics
军用电子产品

Any information here is for reference only. Information is also dependent on actual conditions of use does not guarantee future performance.And subject to change.

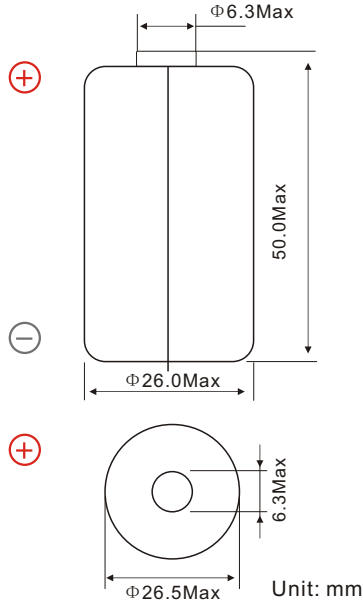

+ Available terminations:

- /P axial pins
- T/PT2 radial pins
- /PT/TP polarized tabs

极端样式:

- /P 轴向碰焊线
- T/PT2 径向插件
- /PT/TP 多脚插件

+ Available terminations can be made as requested.

特殊极端样式可按客户要求订做

Discharge Characteristics 常温负载特性

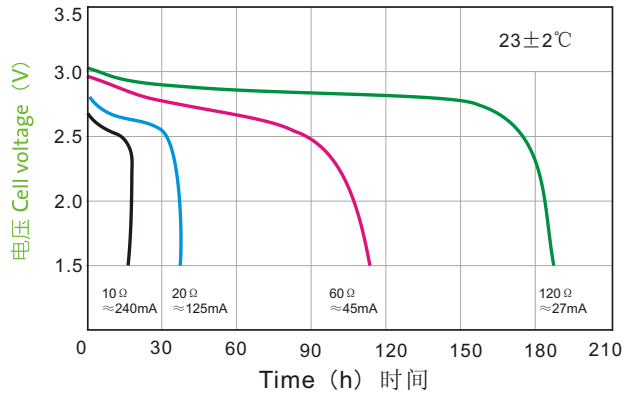

Temperature Characteristics 温度特性

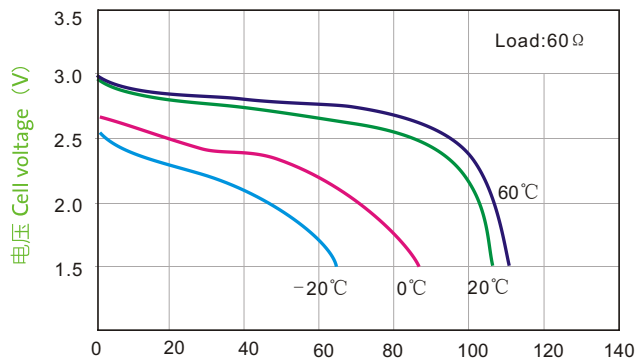

Storage characteristics 存储特性

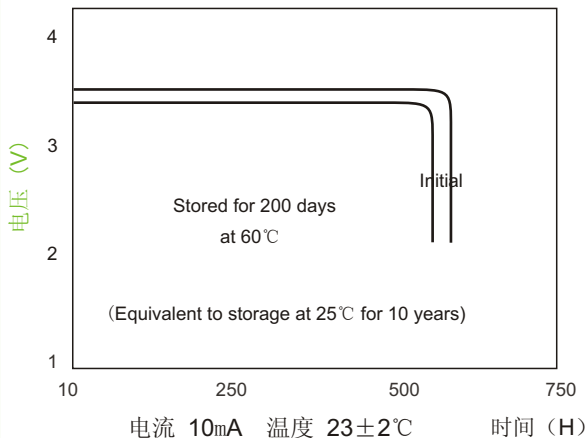

Load-Capacity Characteristics 容量\电流\温度关系特性

