

NUMBER 178289

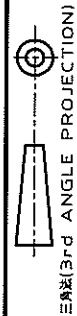

METRIC

PROJ. NO. 393-620
PROJ. NO. 392-603

PRINT DIST
単位: # DIMENSIONS IN MM. DO NOT SCALE PRINT

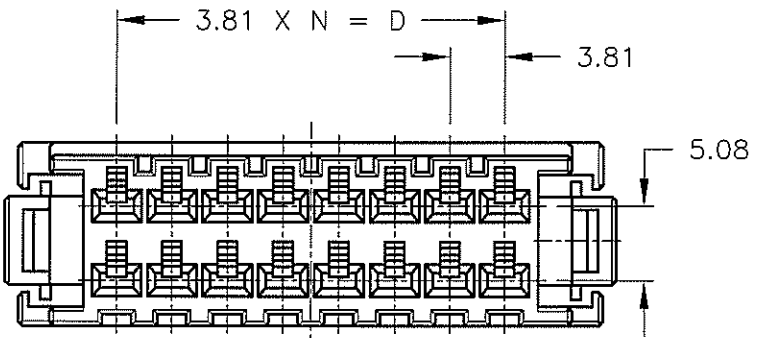
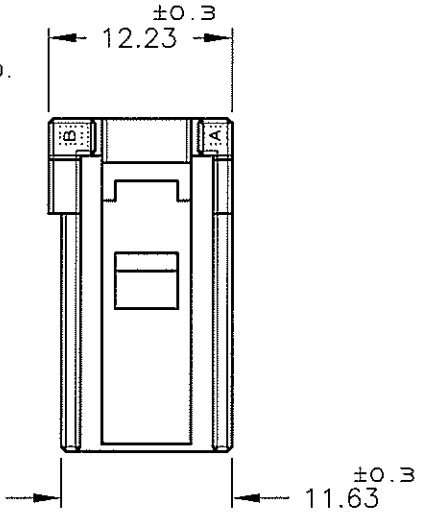
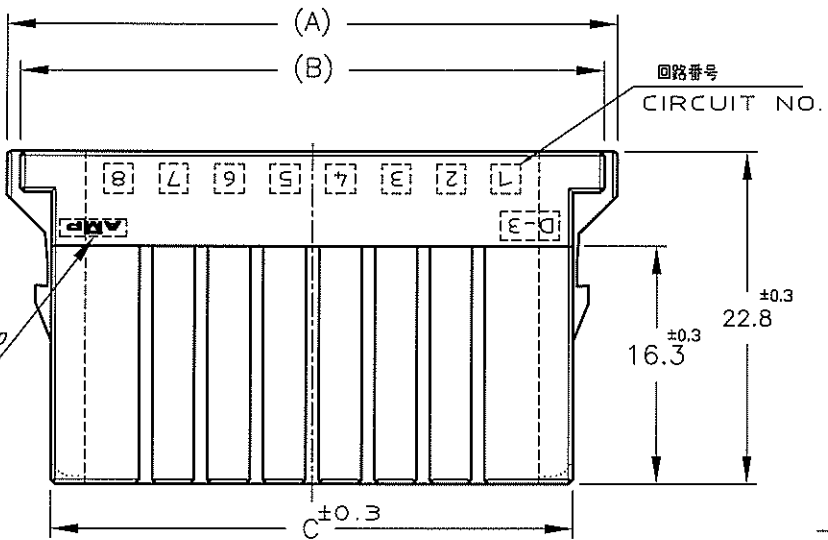
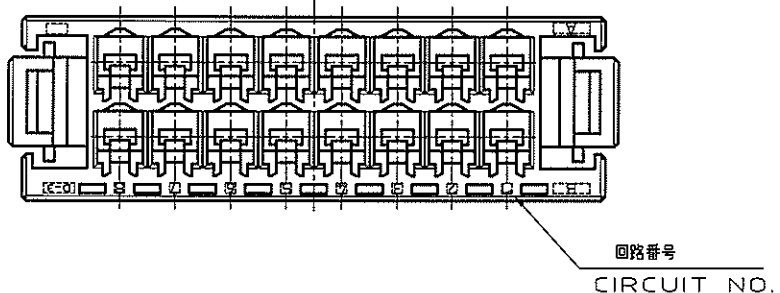

NOTE

- 1 MATERIAL: GLASS FIELD THERMO PLASTIC, POLYESTER
COLOR: BLACK
- 2 TO COAT ALL SURFACE OF HOUSING WITH TEFLON
- 3 THE SHAPE, SIZE AND POSITION OF THE CHARACTER
SHOW THE OUTLINE THEY DON'T SHOW DETAILS

注記

- 1 材料: ガラス入り熱可塑性ポリエステル樹脂
色: 黒色
- 2 ハウジング全面にテフロン塗装のこと
- 3 文字の形状、大きさ、および位置については、大略を示すものであり、
詳細を示すものではありません。

FINISH	POS.	DIMENSION	A	B	C	D	N	PART NUMBER
	20 POS.		51.03	47.83	43.37	34.29	9	0-178289-8
OBSOLETE	16 POS.							5-178289-7
	16 POS.				SEE SHEET 20F2			0-178289-7
	12 POS.		35.79	32.59	28.13	19.05	5	0-178289-6
OBSOLETE	10 POS.		31.98	28.78	24.32	15.24	4	5-178289-5
	10 POS.		31.98	28.78	24.32	15.24	4	0-178289-5
	8 POS.		28.17	24.97	20.51	11.43	3	0-178289-4
OBSOLETE	6 POS.		24.36	21.16	16.70	7.62	2	5-178289-3
	6 POS.		24.36	21.16	16.70	7.62	2	0-178289-3

C6	OBSOLETE P/N. ECR-08-006764	Y.Y	D.M	14 MAR 2008
C5	REVISED ECR-07-023115	Y.Y	D.M	28 SEP 2007
C4	REVISED (FJD0-0292-03)	T.S	S.M	8/29 '03
C3	REVISED (FJD0-0069-03)	T.S	S.M	3/27 '00
C2	ADD P/N. (FJ00-1259-00)	D.M	S.M	11/11 '00
C1	REVISED (FJ00-2338-95)	K.I	S.M	4/11 '95
C	REVISED (FJ00-1085-93)	K.I	S.M	2-23 '94
B	REVISED (FJ00-0017-93)	Y.T	S.M	12-18 '93
LTR	変更 (REVISION RECORD)	DR	CHK	DATE

Copyright ©1993 年 Tyco Electronics Corporation
タイコ・エレクトロニクス・アンプ株式会社 Tyco Electronics AMP K.K. ALL RIGHTS RESERVED.

名称 (NAME)
REC HSG FOR DYNAMIC, DOUBLE ROW
ダイナミックD-3100リセハウジング

一般公差 (GENERAL TOLERANCE)
10mm ±0.2
10mm 30mm ±0.25
30mm 100mm ±0.3
公差: ±3'

SIZE A3 LOC J 番号 (No.) C-178289
尺数 (SCALE) 2-1 REV. C6 SHEET 1 OF 2

DR. 9 JUL 91 N. Matsubara DE. 9 JUL 91 N. Matsubara
CHK. 24 FEB. '92 H. Ogata APP. 4 MAR. '92 S. MANABE

4

3

2

1

NUMBER 178289

NUMBER

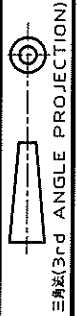

METRIC

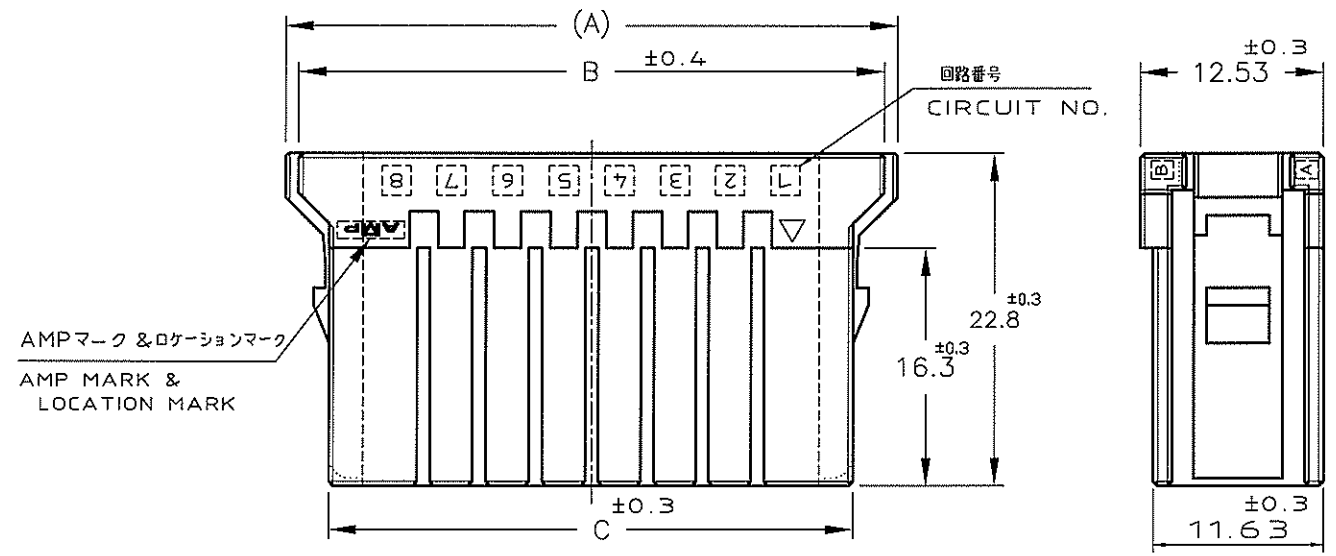
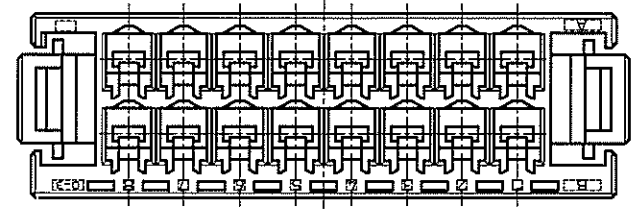

AMPマーク & ロケーションマーク
AMP MARK & LOCATION MARK

回路番号
CIRCUIT NO.

NOTE:SEE SHEET 1 OF 2

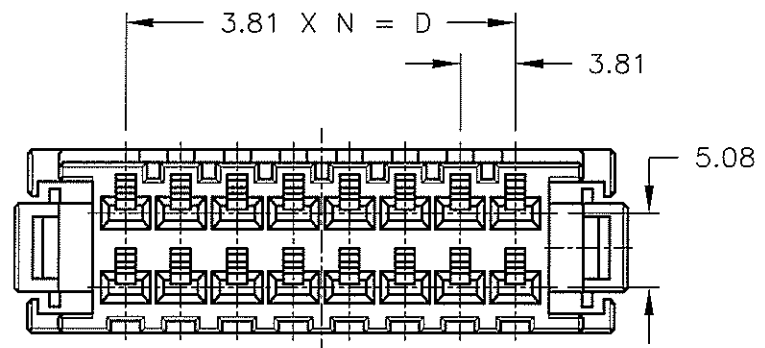

OBSOLETE											5-178289-7
		16POS	42.71	40.21	35.97	26.67	7				0-178289-7
		FINISH POS.	DIMENSION		A	B	C	D	N		PART NUMBER

Copyright ©1993 # タイコ・エレクトロニクス・アンプ株式会社		Copyright ©1993 Tyco Electronics AMP K.K. ALL RIGHTS RESERVED.		Tyco Electronics Tyco Electronics Corporation Kawasaki, Japan	
適合電線径範囲(WIRE RANGE) mm ² (AWG -)	被覆外径(INSULATION DIA.) mmφ	名称(NAME) REC HSG FOR DYNAMIC,DOUBLE ROW ダイナミックD-3100リセハウジング			
材料(MATERIAL)	仕上げ(FINISH)	一般公差 (GENERAL TOLERANCE)	SIZE	LOC	番号(No.)
DR.	DE. APP.	10mmF : ±0.2 104mmL 30mmF : ±0.25 304mmL100mmF : ±0.3 ★ ★ : ±3'	A3	J	178289
SEE 1 OF 2	SEE 1 OF 2	尺取(SCALE)	REV.	C6	SHEET 2 OF 2
LTR 変更 (REVISION RECORD)	DR	CHK	DATE	CHK.	

PRINT DIST
単位: # DIMENSIONS IN MM. DO NOT SCALE PRINT

AMP-J
REV.10/83

(CUSTOMER DRAWING) 顧客用図面