

NUMBER 178288

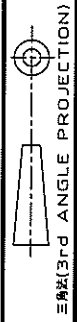

METRIC

PRINT DIST DIMENSIONS IN MM. DO NOT SCALE PRINT

AMP-J REV.10/83

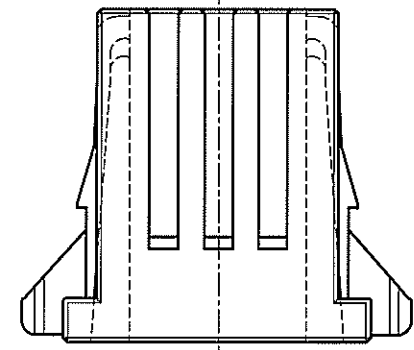
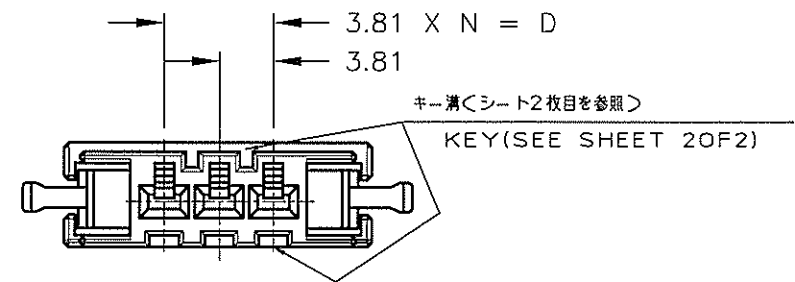
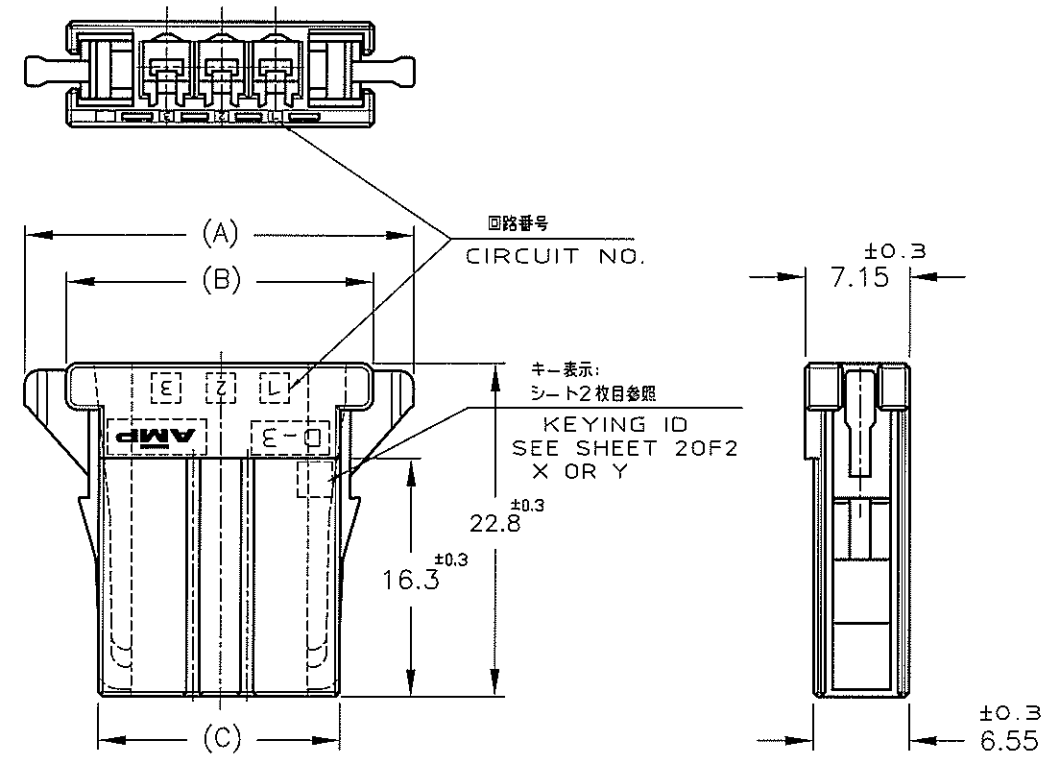

NOTE
1 MATERIAL:GLASS FIELD THERMO PLASTIC,POLYESTER
COLOR;BLACK

~~△ TO COAT ALL SURFACE OF HOUSING WITH TEFLON~~

注記
1 材料：ガラス入り熱可塑性ポリエステル樹脂
色；黒色

~~△ ハリジツク全面にテフロン塗装のこと~~

FINISH	POS.	DIMENSION	A	B	C	D	N	PART NUMBER
	10 POS.		53.43	47.83	43.37	34.29	9	2-178288-8
	10 POS.		53.43	47.83	43.37	34.29	9	1-178288-8
	8 POS.		45.81	40.12	35.97	26.67	7	1-178288-7
	6 POS.		38.19	32.59	28.13	19.05	5	2-178288-6
	6 POS.		38.19	32.59	28.13	19.05	5	1-178288-6
	5 POS.		34.38	28.78	24.32	15.24	4	1-178288-5
	4 POS.		30.57	24.97	20.51	11.43	3	2-178288-4
	4 POS.		30.57	24.97	20.51	11.43	3	1-178288-4
OBSOLETE	3 POS.	26.76	21.16	16.7	7.62	2	2	6-178288-3
OBSOLETE	3 POS.	26.76	21.16	16.7	7.62	2	2	5-178288-3
	3 POS.	26.76	21.16	16.7	7.62	2	2	2-178288-3
	3 POS.	26.76	21.16	16.7	7.62	2	2	1-178288-3

E3 OBSOLETE P/N.(ECR-08-006764)		Y.Y	D.M	14MAR 2008	Copyright ©1991 株式会社エンプラ Copyright ©1991 Tyco Electronics AMP K.K. ALL RIGHTS RESERVED.		Tyco Electronics Tyco Electronics Corporation Kawasaki, Japan	
E2 ADD P/N.(FJ00-1259-00)		D.M	S.M	11OCT '00	結合電線断面積(WIRE RANGE) mm²(AWG -)		被覆外径(INSULATION DIA) mmφ	
E1 REVISED (FJ00-2710-95)		NM	Y.I	6-13 '95	材料(MATERIAL) SEE NOTE 注記参照		仕上(FINISH)	
E REVISED (FJ00-1468-94)		KI	S.M	1-10 '95	一般公差 (GENERAL TOLERANCE)		SIZE	LOC
D REVISED (J-1389)		YT	S.M	6-11 '92	10% ±0.2		A3	J
C REVISED (J-1184)		NM	H.Q	3-4 '92	30% ±0.25		名番(No.) C-178288	
B REDRAWN (J-0327)		NM	H.Q	8-26 '91	100% ±0.3		尺取(SCALE) 2-1	
LTR 変更 (REVISION RECORD)		DR	CHK	DATE	100% ±0.3		REV. E3	
					角 度 ±3'		SHEET 1 OF 2	

(CUSTOMER DRAWING) 顧客用図面

NUMBER 178288



METRIC

PRINT DIST
注: 尺 DIMENSIONS IN MM. DO NOT SCALE PRINT

KEYING LOCATION

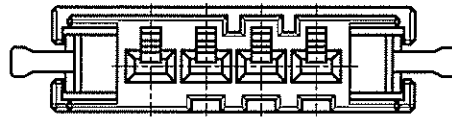

(P/N 2-178288-4 ONLY)
(KEYING: Y)

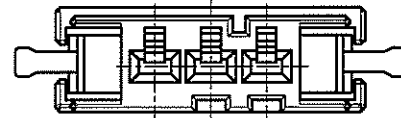

(P/N 2-178288-3 ONLY)
(KEYING: Y)

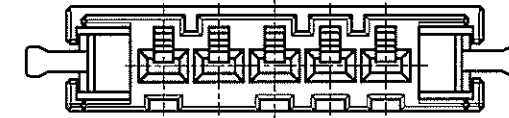

(P/N 2-178288-6,-8)
(KEYING: Y)

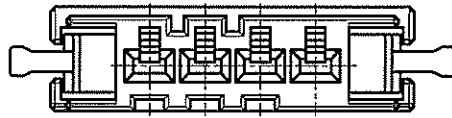

(P/N 1-178288-4 ONLY)
(KEYING: X)

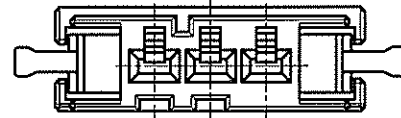

(P/N 1-178288-3 ONLY)
(KEYING: X)

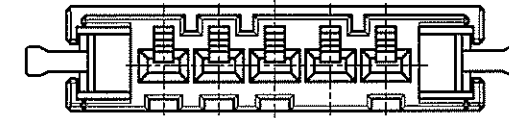

(P/N 1-178288-5,-6,-7,-8)
(KEYING: X)

				Copyright ©1991 * 株式会社チヨコ電子工業		Copyright ©1991 Tyco Electronics AMP K.K. ALL RIGHTS RESERVED.		Tyco Electronics Tyco Electronics Corporation Kawasaki, Japan	
				規格範囲(WIRE RANGE) mmKAWG - >		絶縁外径(INSULATION DIA.) mmφ		名称(NAME) REC HSG FOR DYNAMIC,SINGLE ROW ダイナミックD-310リセハウジング	
				材料(MATERIAL) SEE NOTE 注記参照		仕上(FINISH)		一般公差 (GENERAL TOLERANCE) 10mmF : ±0.2 10mmE 30mmF : ±0.25 30mmE 100mmF : ±0.3 公差 : ±3'	
SEE 1 OF 2				DR.		DE. OF 2		SIZE LOC 番号(No.) A3 J 178288	
LTR	変更 (REVISION RECORD)	DR	CHK	DATE	CHK.	APP.	尺数(SCALE) 2-1		REV. E3
							SHEET 2 OF 2		