



mSMD Series

Features

- Surface Mount Devices
- Lead free device
- Size 4532 mm/1812 mils
- Surface Mount packaging for automated assembly
- Agency recognition: UL

Applications

- Almost anywhere there is a low voltage power supply, up to 33V and a load to be protected, including:
- Computer mother board, Modem, USB hub
 - PDAs & Charger, Analog & digital line card
 - Digital cameras, Disk drivers, CD-ROMs,

Sea & Land

Performance Specification

Model	V _{max} (Vdc)	I _{max} (A)	I _{hold} @25°C (A)	I _{trip} @25°C (A)	P _d Max. (W)	Maximum Time To Trip		Resistance	
						Current (A)	Time (Sec)	R _{i_min} (Ω)	R _{1_max} (Ω)
mSMD010	30.0	100	0.10	0.30	0.8	0.5	1.50	0.750	15.000
mSMD014	33.0	100	0.14	0.34	0.8	1.5	0.15	0.650	6.000
mSMD020	30.0	100	0.20	0.40	0.8	8.0	0.02	0.350	5.000
mSMD030	30.0	100	0.30	0.60	0.8	8.0	0.10	0.250	3.000
mSMD050	15.0	100	0.50	1.00	0.8	8.0	0.15	0.150	1.000
mSMD075	13.2	100	0.75	1.50	0.8	8.0	0.20	0.090	0.450
mSMD110	8.0	100	1.10	2.20	0.8	8.0	0.30	0.050	0.250
mSMD110-16V	16.0	100	1.10	2.20	0.8	8.0	0.30	0.050	0.250
mSMD125	16.0	100	1.25	2.50	0.8	8.0	0.40	0.050	0.140
mSMD150	8.0	100	1.50	3.00	0.8	8.0	0.50	0.040	0.160
mSMD150-16V	16.0	100	1.50	3.00	0.8	8.0	0.50	0.040	0.160
mSMD160	8.0	100	1.60	2.80	0.8	8.0	1.00	0.030	0.130
mSMD200	8.0	100	2.00	4.00	0.8	8.0	2.00	0.020	0.100
mSMD260	8.0	100	2.60	5.00	0.8	8.0	2.50	0.015	0.050

I_{hold} = Hold Current. Maximum current device will not trip in 25°C still air.
I_{trip} = Trip Current. Minimum current at which the device will always trip in 25°C still air.
V_{max} = Maximum operating voltage device can withstand without damage at rated current (I_{max}).
I_{max} = Maximum fault current device can withstand without damage at rated voltage (V_{max}).
P_d = Maximum power dissipation when device is in the tripped state in 25°C still air environment at rated voltage.
R_{imin/max} = Minimum/Maximum device resistance prior to tripping at 25°C.
R_{1_max} = Maximum device resistance is measured one hour post reflow.
CAUTION : Operation beyond the specified ratings may result in damage and possible arcing and flame.

Environmental Specifications

Test	Conditions	Resistance change
Passive aging	+85°C, 1000 hrs.	±5% typical
Humidity aging	+85°C, 85% R.H. , 168 hours	±5% typical
Thermal shock	+85°C to -40°C, 20 times	±33% typical
Resistance to solvent	MIL-STD-202,Method 215	No change
Vibration	MIL-STD-202,Method 201	No change
Ambient operating conditions :	- 40 °C to 85 °C	
Maximum surface temperature of the device in the tripped state is	125 °C	

AGENCY APPROVALS :



U.L. approved



AGENCY FILE NUMBERS : U.L. FILE NO. : E201504

I_{hold} versus temperature

Model	Maximum ambient operating temperature (T _{mao}) vs. hold current (I _{hold})								
	-40°C	-20°C	0°C	20°C	40°C	50°C	60°C	70°C	85°C
mSMD010	0.16	0.14	0.12	0.11	0.08	0.07	0.06	0.05	0.03
mSMD014	0.23	0.19	0.17	0.14	0.12	0.10	0.09	0.08	0.06
mSMD020	0.29	0.26	0.23	0.20	0.17	0.15	0.14	0.12	0.10
mSMD030	0.44	0.39	0.35	0.30	0.26	0.23	0.21	0.18	0.15
mSMD050	0.59	0.57	0.55	0.50	0.45	0.43	0.35	0.30	0.23
mSMD075	1.10	0.99	0.87	0.75	0.63	0.57	0.49	0.45	0.35
mSMD110	1.60	1.45	1.28	1.10	0.92	0.83	0.71	0.66	0.52
Msmid125	2.00	1.75	1.52	1.25	1.00	0.95	0.90	0.75	0.53
mSMD150	2.30	2.05	1.77	1.50	1.23	1.09	0.95	0.82	0.61
mSMD200	2.88	2.61	2.25	2.00	1.80	1.66	1.45	1.39	1.19

Construction and Dimension (Unit:mm)

Model	A		B		C		D	E
	Min.	Max.	Min.	Max.	Min.	Max.	Min.	Min.
mSMD010	4.37	4.73	3.07	3.41	0.50	1.00	0.30	0.25
mSMD014	4.37	4.73	3.07	3.41	0.50	1.00	0.30	0.25
mSMD020	4.37	4.73	3.07	3.41	0.50	1.00	0.30	0.25
mSMD030	4.37	4.73	3.07	3.41	0.50	1.00	0.30	0.25
mSMD050	4.37	4.73	3.07	3.41	0.27	0.65	0.30	0.25
mSMD075	4.37	4.73	3.07	3.41	0.27	0.65	0.30	0.25
mSMD110	4.37	4.73	3.07	3.41	0.27	0.65	0.30	0.25
mSMD110-16V	4.37	4.73	3.07	3.41	0.27	0.65	0.30	0.25
mSMD125	4.37	4.73	3.07	3.41	0.27	0.65	0.30	0.25
mSMD150	4.37	4.73	3.07	3.41	0.27	0.65	0.30	0.25
mSMD150-16V	4.37	4.73	3.07	3.41	0.27	0.65	0.30	0.25
mSMD160	4.37	4.73	3.07	3.41	0.27	0.65	0.30	0.25
mSMD200	4.37	4.73	3.07	3.41	0.50	1.10	0.30	0.25
mSMD260	4.37	4.73	3.07	3.41	0.50	1.80	0.30	0.25

Dimensions & Marking

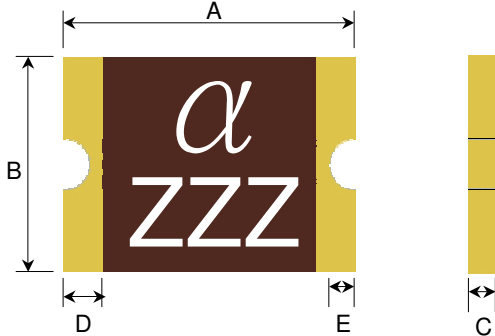

Recommended pad layout (mm)

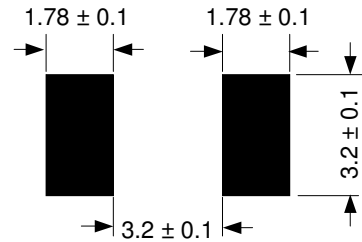

α = Trademark
ZZZ = Hold current

Termination pad characteristics

Terminal pad materials : Tin-Plated Nickle-Copper or Gold-Plated Nickle-Copper

Terminal pad solderability : Meets EIA specification RS186-9E and ANSI/J-STD-002 Category 3.

Rework

Use standard industry practices, the removal device must be replaced with a fresh one.

Thermal derating curve

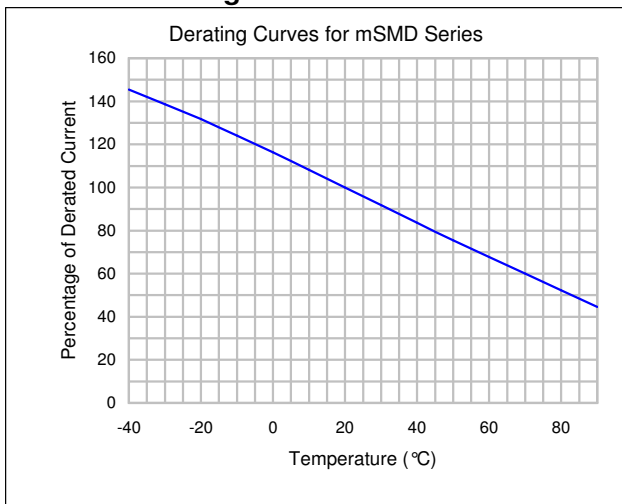

Typical time-to-trip at 25°C

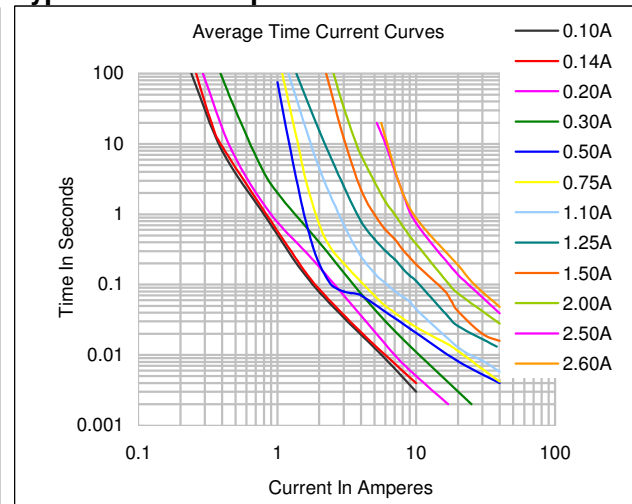

Recommended solder reflow conditions

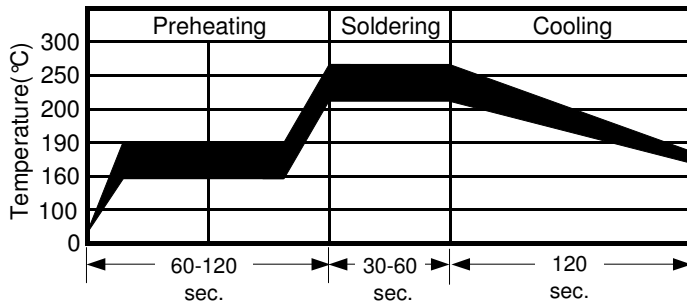

- Recommended reflow methods : IR, vapor phase oven, hot air oven.
 - Devices are not designed to be wave soldered to the bottom side of the board.
 - Recommended maximum paste thickness is 0.25 mm (0.010 inch).
 - Devices can be cleaned using standard method and solvents.
- Note : If reflow temperatures exceed the recommended profile, devices may not meet the performance requirements.

Tape and reel specifications (mm)

	miniSMD
Governing Specifications	EIA 481-1
W	12 ± 0.3
P ₀	4.0 ± 0.10
P ₁	8.0 ± 0.10
P ₂	2.0 ± 0.05
A ₀	3.5 ± 0.23
B ₀	5.1 ± 0.15
B ₁ max.	5.9
D ₀	1.5 + 0.1, -0
F	5.5 ± 0.05
E ₁	1.75 ± 0.10
E ₂ min.	10.25
Tmax.	0.6
T ₁ max.	0.1
K ₀	0.9 ± 0.15
Leader min.	390
Trailer min.	160
Reel Dimensions	
A max.	178
N min.	60
W ₁	12.4 + 2.0, -0.0
W ₂ max.	18.4

EIA Tape Component Dimensions

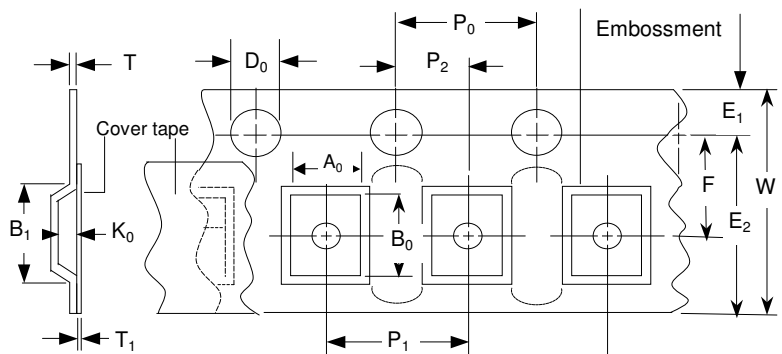

EIA Reel Dimensions

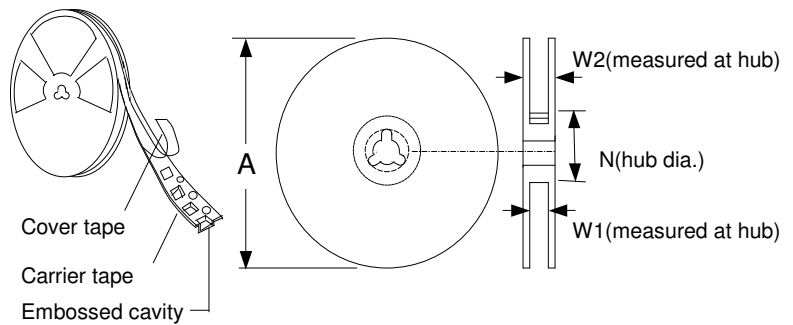

Storage and handling

- Storage conditions : 40°C max, 70% R.H.
- Devices may not meet specified performance if storage conditions are exceeded.

Order information

mSMD	110	Tape & Reel Quantity 2,000 pcs/reel
Product name	Hold	
mini size 4532 mm / 1812 mils	Current	
SMD : surface mount device	1.10A	

Tape & reel packaging per EIA481-1