

# Mini Jack (Discrete Type)

## Features

1. LGY2502-0200 and LGY2512-0100 type, downsized to 5.0x6.5x14.0 mm and economical, is a choice for making end products downsized and reduced in weight.
2. A single standard mounting provision can accept either LGY6501-0600, designed for a monaural circuit, or LGY6502-0600, for a stereo circuit, which share one body configuration and pin arrangement.
3. Available also in a vertical design to meet diverse user requirements for enhanced freedom in designing end products.
4. To effectively counter noise, use of types with a ground plate or shield cover is recommended.

## Applications

Personal computers and peripherals, audio visual equipment, etc.

## ø2.5 Jack

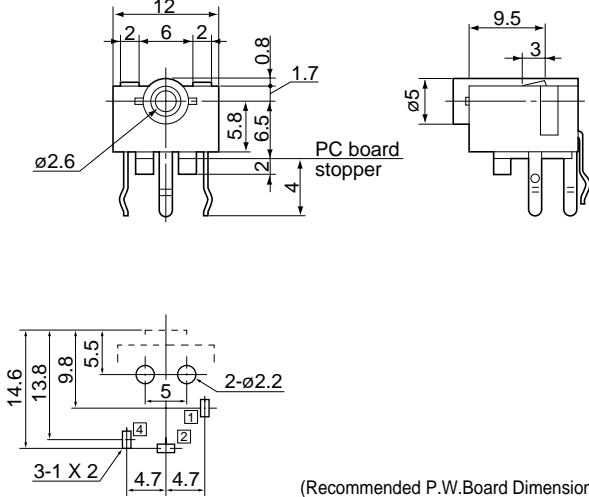
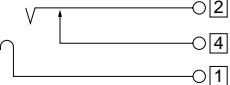
<p><b>LGK6501-0300</b></p> <p><b>H=6.5mm</b></p> 	 <p>(Recommended P.W.Board Dimension) (The Pattern Side)</p>	<p>Circuits</p> 
<p><b>Horizontal</b></p>		



# ø2.5 Jack

## LGK1309-0300

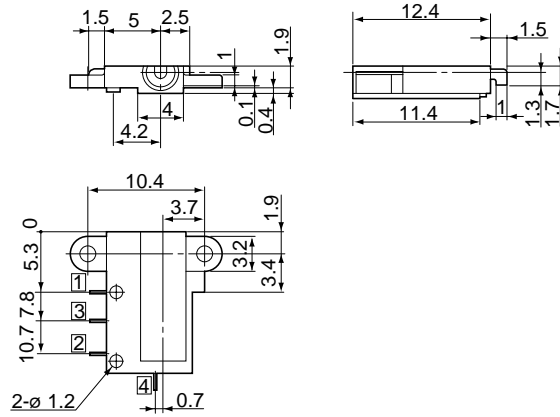

Circuits

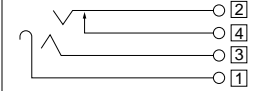

**Horizontal**

## LGK1001-0100

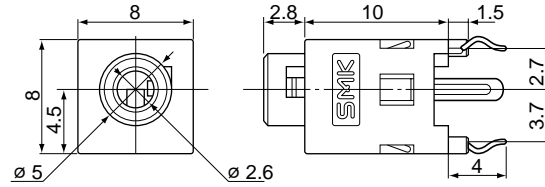

Circuits

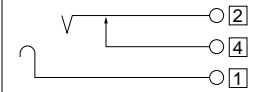

**Vertical**

(Recommended P.W.Board Dimension)  
(The Pattern Side)