

PCI2040 PCI-DSP Bridge Controller

Data Manual



PCI2040 PCI-DSP Bridge Controller Data Manual

Literature Number: SCPS048A
September 2006



IMPORTANT NOTICE

Texas Instruments Incorporated and its subsidiaries (TI) reserve the right to make corrections, modifications, enhancements, improvements, and other changes to its products and services at any time and to discontinue any product or service without notice. Customers should obtain the latest relevant information before placing orders and should verify that such information is current and complete. All products are sold subject to TI's terms and conditions of sale supplied at the time of order acknowledgment.

TI warrants performance of its hardware products to the specifications applicable at the time of sale in accordance with TI's standard warranty. Testing and other quality control techniques are used to the extent TI deems necessary to support this warranty. Except where mandated by government requirements, testing of all parameters of each product is not necessarily performed.

TI assumes no liability for applications assistance or customer product design. Customers are responsible for their products and applications using TI components. To minimize the risks associated with customer products and applications, customers should provide adequate design and operating safeguards.

TI does not warrant or represent that any license, either express or implied, is granted under any TI patent right, copyright, mask work right, or other TI intellectual property right relating to any combination, machine, or process in which TI products or services are used. Information published by TI regarding third-party products or services does not constitute a license from TI to use such products or services or a warranty or endorsement thereof. Use of such information may require a license from a third party under the patents or other intellectual property of the third party, or a license from TI under the patents or other intellectual property of TI.

Reproduction of information in TI data books or data sheets is permissible only if reproduction is without alteration and is accompanied by all associated warranties, conditions, limitations, and notices. Reproduction of this information with alteration is an unfair and deceptive business practice. TI is not responsible or liable for such altered documentation.

Resale of TI products or services with statements different from or beyond the parameters stated by TI for that product or service voids all express and any implied warranties for the associated TI product or service and is an unfair and deceptive business practice. TI is not responsible or liable for any such statements.

Following are URLs where you can obtain information on other Texas Instruments products and application solutions:

Products		Applications	
Amplifiers	amplifier.ti.com	Audio	www.ti.com/audio
Data Converters	dataconverter.ti.com	Automotive	www.ti.com/automotive
DSP	dsp.ti.com	Broadband	www.ti.com/broadband
Interface	interface.ti.com	Digital Control	www.ti.com/digitalcontrol
Logic	logic.ti.com	Military	www.ti.com/military
Power Mgmt	power.ti.com	Optical Networking	www.ti.com/opticalnetwork
Microcontrollers	microcontroller.ti.com	Security	www.ti.com/security
Low Power Wireless	www.ti.com/lpw	Telephony	www.ti.com/telephony
		Video & Imaging	www.ti.com/video
		Wireless	www.ti.com/wireless

Mailing Address: Texas Instruments
Post Office Box 655303 Dallas, Texas 75265

Contents

<i>Section</i>	<i>Title</i>	<i>Page</i>
1	Introduction	1-1
1.1	Description	1-1
1.2	Features	1-1
1.3	Related Documents	1-1
1.4	Ordering Information	1-1
2	Terminal Descriptions	2-1
3	PCI2040 Functional Description	3-1
3.1	PCI Interface	3-1
3.2	Accessing Internal PCI2040 Registers	3-2
3.3	PCI_LOCK	3-2
3.4	Serial ROM Interface	3-2
3.5	PCI2040 Host Port Interface	3-3
3.5.1	Identifying Implemented Ports and DSP Types	3-3
3.5.2	DSP Chip Selects	3-4
3.5.3	HPI Register Access Control	3-4
3.5.4	Mapping HPI DSP Memory to the Host	3-4
3.5.5	Read/Write Procedure	3-4
3.5.6	HPI Interface Specific Notes	3-5
3.6	General-Purpose I/O Interface	3-6
3.7	Interrupts	3-6
3.7.1	Interrupt Event and Interrupt Mask Registers	3-6
3.7.2	DSP-to-Host Interrupts	3-6
3.7.3	HPI Error Interrupts and HPI Error Reporting	3-7
3.7.4	General-Purpose Interrupts	3-7
3.7.5	Interrupts Versus $\overline{\text{PME}}$	3-7
3.8	PCI2040 Power Management	3-7
3.8.1	PCI Power Management Register Interface	3-8
3.8.2	PCI Power Management Device States and Transitions	3-8
3.9	Compact PCI Hot-Swap	3-9
3.10	General-Purpose Bus	3-10
3.11	Example Transactions on the General-Purpose Bus	3-11
3.11.1	General-Purpose Bus Word Write	3-11
3.11.2	General-Purpose Bus Word Read	3-11

<i>Section</i>	<i>Title</i>	<i>Page</i>
4	PCI2040 Programming Model	4-1
4.1	PCI Configuration Registers	4-1
4.2	Vendor and Device ID Register	4-2
4.3	PCI Command Register	4-3
4.4	PCI Status Register	4-4
4.5	Revision ID	4-4
4.6	Class Code	4-5
4.7	Cache Line Size Register	4-5
4.8	Latency Timer Register	4-5
4.9	Header Type Register	4-6
4.10	BIST Register	4-6
4.11	HPI CSR Memory Base Address Register	4-7
4.12	Control Space Base Address Register	4-8
4.13	GP Bus Base Address Register	4-9
4.14	Subsystem Vendor ID Register	4-9
4.15	Subsystem ID Register	4-10
4.16	Capability Pointer Register	4-10
4.17	Interrupt Line Register	4-10
4.18	Interrupt Pin Register	4-11
4.19	MIN_GNT Register	4-11
4.20	MAX_LAT Register	4-11
4.21	GPIO Select Register	4-12
4.22	GPIO Input Data Register	4-13
4.23	GPIO Direction Control Register	4-13
4.24	GPIO Output Data Register	4-14
4.25	GPIO Interrupt Event Type Register	4-14
4.26	Miscellaneous Control Register	4-15
4.27	Diagnostic Register	4-16
4.28	PM Capability ID Register	4-16
4.29	PM Next-Item Pointer Register	4-17
4.30	Power Management Capabilities Register	4-17
4.31	Power Management Control/Status Register	4-18
4.32	HPI CSR I/O Base Address Register	4-19
4.33	HS Capability ID Register	4-19
4.34	HS Next-Item Pointer Register	4-20
4.35	CPCI Hot Swap Control and Status Register	4-20
5	HPI Control and Status Registers (HPI CSR)	5-1
5.1	Interrupt Event Register	5-2
5.2	Interrupt Mask Register	5-3
5.3	HPI Error Report Register	5-4
5.4	HPI Reset Register	5-4
5.5	HPI DSP Implementation Register	5-5
5.6	HPI Data Width Register	5-5

<i>Section</i>	<i>Title</i>	<i>Page</i>
6	DSP HPI Overview	6-1
6.1	C54X Host Port Interface	6-1
6.1.1	Modes of Operation	6-1
6.1.2	HPI Functional Description	6-1
6.1.3	HPI Registers	6-1
6.2	C54X HPI Control Register	6-3
6.2.1	Auto Increment Feature	6-3
6.2.2	Interrupts	6-3
6.2.3	Four Strobes ($\overline{\text{HDS1}}$, $\overline{\text{HDS2}}$, $\overline{\text{HR/W}}$, $\overline{\text{HAS}}$)	6-4
6.2.4	Wait States	6-4
6.2.5	Host Read/Write Access to HPI	6-4
6.2.6	HPI Memory Access During Reset	6-5
6.2.7	Examples of Transactions Targeting the C54X	6-5
6.2.7.1	PCI Word Write	6-5
6.2.7.2	PCI Word Read	6-6
6.2.7.3	PCI Double Word Write	6-7
6.2.7.4	PCI Double Word Read	6-8
6.3	C6X HPI Interface	6-8
6.3.1	No SAM or HOM Modes	6-8
6.3.2	Address/Data Bus	6-9
6.3.3	Byte Enables ($\overline{\text{HBE0}}$ and $\overline{\text{HBE1}}$)	6-9
6.3.4	Wait States	6-9
6.3.5	C6X HPI Registers	6-10
6.3.6	Software Handshaking Using HRDY and FETCH	6-11
6.3.7	Host Access Sequence	6-12
6.3.8	Single Half-Word Cycles	6-12
6.3.9	Memory Access Through HPI During Reset	6-12
6.3.10	Examples of Transactions Targeting the C6X	6-12
7	Electrical Characteristics	7-1
7.1	Absolute Maximum Ratings Over Operating Temperature Ranges	7-1
7.2	Recommended Operating Conditions	7-2
7.3	Electrical Characteristics Over Recommended Operating Conditions	7-3
8	Mechanical Information	8-1

List of Illustrations

<i>Figure</i>	<i>Title</i>	<i>Page</i>
2-1	PCI2040 Pin Diagram	2-1
3-1	PCI2040 System Block Diagram	3-1
3-2	PCI2040 Serial ROM Data Format	3-3
3-3	PCI2040 Reset Illustration	3-9
3-4	General-Purpose Bus Word Write	3-11
3-5	General-Purpose Bus Word Read	3-12
6-1	C54X Select Input Logic	6-4
6-2	Word Write To HPID Without Auto-Increment Enabled	6-6
6-3	Word Write From HPID Without Auto-Increment Enabled	6-7
6-4	Doubleword Write To HPID Without Auto-Increment Enabled	6-8
6-5	Doubleword Read From HPID Without Auto-Increment Enabled	6-8
6-6	Double Word Write To HPID Without Auto-Increment Selected	6-13
6-7	Double Word Read From HPID Without Auto-Increment Selected	6-13

List of Tables

<i>Table</i>	<i>Title</i>	<i>Page</i>
2-1	Card Signal Names by GGU/PGE Pin Number	2-2
2-2	Card Signal Names Sorted Alphabetically	2-3
2-3	Power Supply	2-4
2-4	PCI System Terminal Functions	2-5
2-5	Miscellaneous Terminal Functions	2-6
2-6	Host Port Interface Terminal Functions	2-7
2-7	Compact PCI Hot Swap Interface	2-8
2-8	General-Purpose Bus Interface	2-8
3-1	PCI2040 Chip Select Decoding	3-4
3-2	HPI Interface Features	3-5
3-3	PMC Changes for PCI PM 1.1 Register Model	3-8
3-4	General-Purpose Bus Signals	3-10
4-1	PCI Configuration Registers	4-1
4-2	Bit Field Access Tag Descriptions	4-2
4-3	PCI Command Register	4-3
4-4	PCI Status Register	4-4
4-5	HPI CSR Memory Base Address Register	4-7
4-6	Control Space Base Address Register	4-8
4-7	General-Purpose Bus Base Address Register	4-9
4-8	GPIO Select Register	4-12
4-9	GPIO Input Data Register	4-13
4-10	GPIO Direction Control Register	4-13
4-11	GPIO Output Data Register	4-14
4-12	GPIO Interrupt Event Type Register	4-14
4-13	Miscellaneous Control Register	4-15
4-14	Diagnostic Register	4-16
4-15	Power Management Capabilities Register	4-17
4-16	Power Management Control/Status Register	4-18
4-17	HPI CSR I/O Base Address Register	4-19
4-18	CPCI Hot Swap Control and Status Register	4-20
5-1	HPI Configuration Register Map	5-1
5-2	Interrupt Event Register	5-2
5-3	Interrupt Mask Register	5-3
5-4	HPI Error Report Register	5-4
5-5	HPI Reset Register	5-4
5-6	HPI DSP Implementation Register	5-5
5-7	HPI Data Width Register	5-5

<i>Table</i>	<i>Title</i>	<i>Page</i>
6-1	C54X HPI Registers Access Control	6-2
6-2	C54X HPI Control Register Description	6-3
6-3	HCNTL0 and HCNTL1 in C6X	6-10
6-4	C6X HPI Control Register	6-11

1 Introduction

1.1 Description

The TI PCI2040 is a PCI-DSP bridge that provides a glueless connection between the 8-bit host port interface (HPI) port on the TMS320C54X or the 16-bit HPI port on TMS320C6X to the high performance PCI bus. It provides a PCI bus target interface compliant with the *PCI Local Bus Specification*.

The PCI2040 provides several external interfaces: the PCI bus interface with compact PCI support, the HPI port interface with support for up to four DSPs, a serial ROM interface, a general-purpose input/output interface (GPIOs), and a 16-bit general-purpose bus to provide a glueless interface to TI JTAG test bus controller (TBC). The PCI2040 universal target-only PCI interface is compatible with 3.3-V or 5-V signaling environments.

The PCI2040 interfaces with DSPs via a data bus (HPI port). The PCI2040 also provides a serial ROM interface for preloading several registers including the subsystem ID and subsystem vendor ID.

The PCI2040, compliant with the latest *PCI Bus Power Management Interface Specification*, provides several low-power features that reduce power consumption. Furthermore, an advanced CMOS process achieves low system power consumption.

Unused PCI2040 inputs must be pulled to a valid logic level using a pullup resistor.

1.2 Features

The PCI2040 supports the following features:

- PCI bus target only, supporting both single-word reads and writes
- Write transaction posting for improved PCI bus performance
- Provides glueless interface to host port interface (HPI) port of C54x and/or C6x
- Up to four DSP devices on HPI
- Allows direct access to program and control external devices connected to PCI2040
- Serial ROM interface for loading subsystem ID and subsystem vendor ID
- A 16-bit general-purpose bus (GPB) that provides glueless interface to TI JTAG TBC
- 3.3-V core logic with universal PCI interface compatible with 3.3-V or 5-V signaling environments
- Advanced submicron, low-power CMOS technology
- 144-pin device and choice of surface mount packaging: TQFP or 12 mm x 12 mm MicroStar BGA
- Up to 33 MHz PCI bus frequency

1.3 Related Documents

- *Compact PCI Hot Swap Specification PICMG 2.1* (Revision 1.0)
- *PCI Bus Power Management Interface Specification* (Revision 1.1)
- *PCI Local Bus Specification* (Revision 2.2)
- *PC 98/99*

1.4 Ordering Information

ORDERING NUMBER	NAME	VOLTAGE	PACKAGE
PCI2040	PCI-DSP Bridge Controller	3.3 V, 5-V Tolerant I/Os	144-pin LQFP 144-ball PBGA

2 Terminal Descriptions

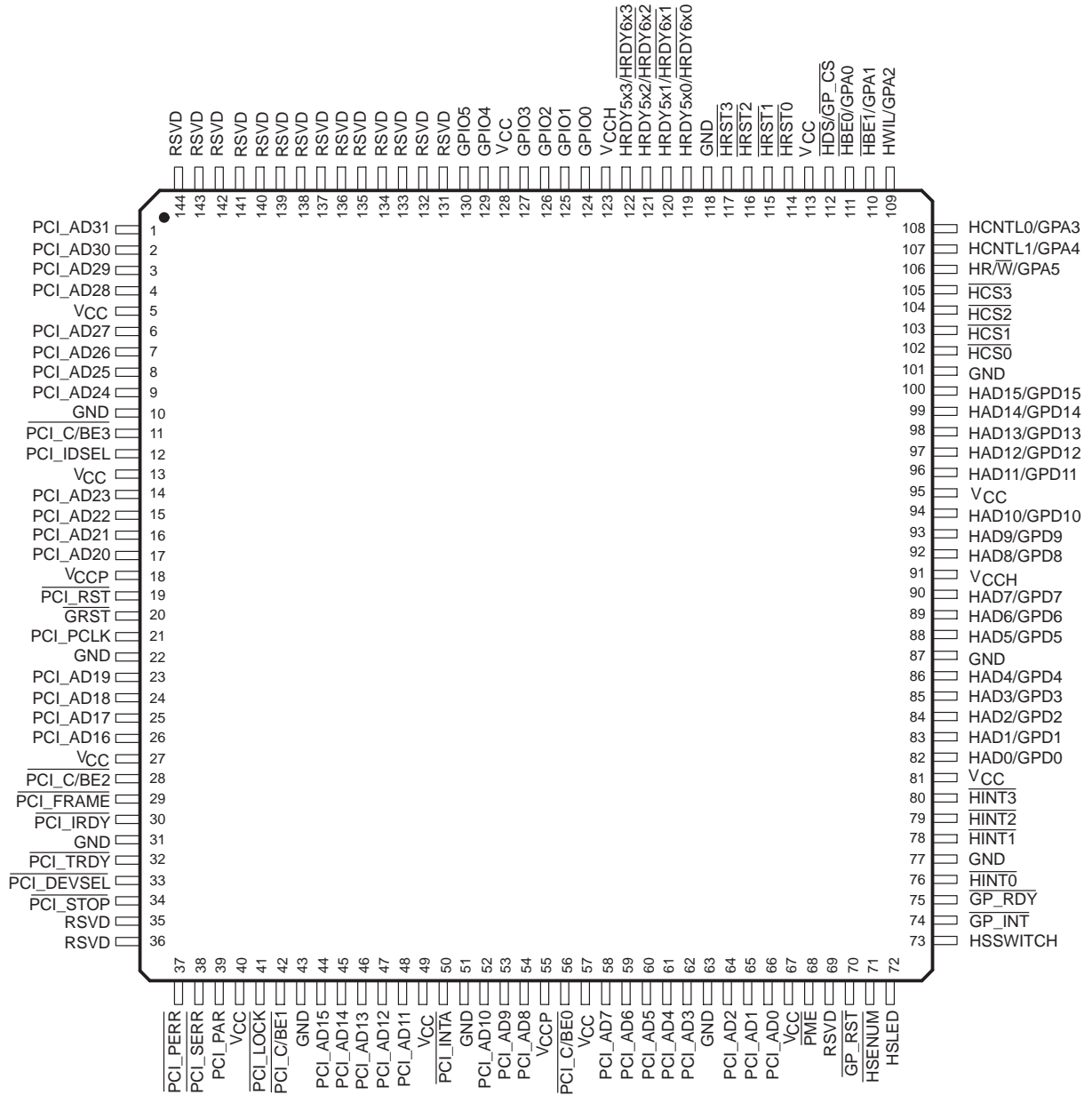

Figure 2–1. PCI2040 Pin Diagram

Table 2–1 shows the card signal names and their terminal assignments sorted alphanumerically by the associated GGU package terminal number. Table 2–2 shows the card signal names sorted alphabetically by the signal name and its associated terminal numbers.

Table 2–1. Card Signal Names by GGU/PGE Pin Number

PIN NO.		SIGNAL NAME	PIN NO.		SIGNAL NAME	PIN NO.		SIGNAL NAME	PIN NO.		SIGNAL NAME
GGU	PGE		GGU	PGE		GGU	PGE		GGU	PGE	
A1	1	PCI_AD31	C11	106	HR \overline{W} /GPA5	G10	92	HAD8/GPD8	L4	42	PCI_C/BE1
A2	143	RSVD	C12	105	HCS3	G11	91	V \overline{CCH}	L5	46	PCI_AD13
A3	140	RSVD	C13	104	HCS2	G12	89	HAD6/GPD6	L6	50	PCI_INTA
A4	137	RSVD	D1	8	PCI_AD25	G13	90	HAD7/GPD7	L7	55	V \overline{CCP}
A5	133	RSVD	D2	7	PCI_AD26	H1	21	PCI_PCLK	L8	59	PCI_AD6
A6	129	GPIO4	D3	6	PCI_AD27	H2	22	GND	L9	63	GND
A7	126	GPIO2	D4	5	V \overline{CC}	H3	23	PCI_AD19	L10	67	V \overline{CC}
A8	124	GPIO0	D5	136	RSVD	H4	24	PCI_AD18	L11	70	GP \overline{RST}
A9	120	HRDY5x1/HRDY6x1	D6	132	RSVD	H10	85	HAD3/GPD3	L12	75	GP \overline{RDY}
A10	116	HRST2	D7	128	V \overline{CC}	H11	86	HAD4/GPD4	L13	76	HINT0
A11	112	HDS/GP \overline{CS}	D8	121	HRDY5x2/HRDY6x2	H12	87	GND	M1	35	RSVD
A12	110	HBE1/GPA1	D9	117	HRST3	H13	88	HAD5/GPD5	M2	36	RSVD
A13	109	HWIL/GPA2	D10	113	V \overline{CC}	J1	25	PCI_AD17	M3	39	PCI_PAR
B1	2	PCI_AD30	D11	103	HCS1	J2	26	PCI_AD16	M4	43	GND
B2	144	RSVD	D12	102	HCS0	J3	27	V \overline{CC}	M5	47	PCI_AD12
B3	141	RSVD	D13	101	GND	J4	28	PCI_C/BE2	M6	51	GND
B4	138	RSVD	E1	12	PCI_IDSEL	J10	81	V \overline{CC}	M7	53	PCI_AD9
B5	134	RSVD	E2	11	PCI_C/BE3	J11	82	HAD0/GPD0	M8	58	PCI_AD7
B6	130	GPIO5	E3	10	GND	J12	83	HAD1/GPD1	M9	62	PCI_AD3
B7	125	GPIO1	E4	9	PCI_AD24	J13	84	HAD2/GPD2	M10	66	PCI_AD0
B8	123	V \overline{CCH}	E10	100	HAD15/GPD15	K1	29	PCI_FRAME	M11	69	RSVD
B9	119	HRDY5x0/HRDY6x0	E11	99	HAD14/GPD14	K2	30	PCI_IRDY	M12	72	HSLED
B10	115	HRST1	E12	98	HAD13/GPD13	K3	31	GND	M13	74	GP \overline{INT}
B11	111	HBE0/GPA0	E13	97	HAD12/GPD12	K4	41	PCI_LOCK	N1	37	PCI_PERR
B12	108	HCNTL0/GPA3	F1	16	PCI_AD21	K5	45	PCI_AD14	N2	38	PCI_SERR
B13	107	HCNTL1/GPA4	F2	15	PCI_AD22	K6	49	V \overline{CC}	N3	40	V \overline{CC}
C1	4	PCI_AD28	F3	14	PCI_AD23	K7	56	PCI_C/BE0	N4	44	PCI_AD15
C2	3	PCI_AD29	F4	13	V \overline{CC}	K8	60	PCI_AD5	N5	48	PCI_AD11
C3	142	RSVD	F10	96	HAD11/GPD11	K9	64	PCI_AD2	N6	52	PCI_AD10
C4	139	RSVD	F11	95	V \overline{CC}	K10	77	GND	N7	54	PCI_AD8
C5	135	RSVD	F12	94	HAD10/GPD10	K11	78	HINT1	N8	57	V \overline{CC}
C6	131	RSVD	F13	93	HAD9/GPD9	K12	79	HINT2	N9	61	PCI_AD4
C7	127	GPIO3	G1	18	V \overline{CCP}	K13	80	HINT3	N10	65	PCI_AD1
C8	122	HRDY5x3/HRDY6x3	G2	17	PCI_AD20	L1	32	PCI_TRDY	N11	68	PME
C9	118	GND	G3	19	PCI_RST	L2	33	PCI_DEVSEL	N12	71	HSENUM
C10	114	HRST0	G4	20	GRST	L3	34	PCI_STOP	N13	73	HSSWITCH

Table 2–2. Card Signal Names Sorted Alphabetically

SIGNAL NAME	PIN NO.		SIGNAL NAME	PIN NO.		SIGNAL NAME	PIN NO.		SIGNAL NAME	PIN NO.	
	GGU	PGE		GGU	PGE		GGU	PGE		GGU	PGE
GRST	G4	20	HBE0/GPA0	B11	111	PCI_AD10	N6	52	PCI_SERR	N2	38
GND	E3	10	HBE1/GPA1	A12	110	PCI_AD11	N5	48	PCI_STOP	L3	34
GND	H2	22	HCNTL0/GPA3	B12	108	PCI_AD12	M5	47	PCI_TRDY	L1	32
GND	K3	31	HCNTL1/GPA4	B13	107	PCI_AD13	L5	46	PME	N11	68
GND	M4	43	HCS0	D12	102	PCI_AD14	K5	45	RSVD	M1	35
GND	M6	51	HCS1	D11	103	PCI_AD15	N4	44	RSVD	M2	36
GND	L9	63	HCS2	C13	104	PCI_AD16	J2	26	RSVD	M11	69
GND	K10	77	HCS3	C12	105	PCI_AD17	J1	25	RSVD	C6	131
GND	H12	87	HDS/GP_CS	A11	112	PCI_AD18	H4	24	RSVD	D6	132
GND	D13	101	HINT0	L13	76	PCI_AD19	H3	23	RSVD	A5	133
GND	C9	118	HINT1	K11	78	PCI_AD20	G2	17	RSVD	B5	134
GP_INT	M13	74	HINT2	K12	79	PCI_AD21	F1	16	RSVD	C5	135
GP_RDY	L12	75	HINT3	K13	80	PCI_AD22	F2	15	RSVD	D5	136
GP_RST	L11	70	HRW/GPA5	C11	106	PCI_AD23	F3	14	RSVD	A4	137
GPIO0	A8	124	HRDY5x0/HRDY6x0	B9	119	PCI_AD24	E4	9	RSVD	B4	138
GPIO1	B7	125	HRDY5x1/HRDY6x1	A9	120	PCI_AD25	D1	8	RSVD	C4	139
GPIO2	A7	126	HRDY5x2/HRDY6x2	D8	121	PCI_AD26	D2	7	RSVD	A3	140
GPIO3	C7	127	HRDY5x3/HRDY6x3	C8	122	PCI_AD27	D3	6	RSVD	B3	141
GPIO4	A6	129	HRST0	C10	114	PCI_AD28	C1	4	RSVD	C3	142
GPIO5	B6	130	HRST1	B10	115	PCI_AD29	C2	3	RSVD	A2	143
HAD0/GPD0	J11	82	HRST2	A10	116	PCI_AD30	B1	2	RSVD	B2	144
HAD1/GPD1	J12	83	HRST3	D9	117	PCI_AD31	A1	1	VCC	D4	5
HAD2/GPD2	J13	84	HSENUM	N12	71	PCI_C/BE0	K7	56	VCC	F4	13
HAD3/GPD3	H10	85	HSLED	M12	72	PCI_C/BE1	L4	42	VCC	J3	27
HAD4/GPD4	H11	86	HSSWITCH	N13	73	PCI_C/BE2	J4	28	VCC	N3	40
HAD5/GPD5	H13	88	HWIL/GPA2	A13	109	PCI_C/BE3	E2	11	VCC	K6	49
HAD6/GPD6	G12	89	PCI_AD0	M10	66	PCI_DEVSEL	L2	33	VCC	N8	57
HAD7/GPD7	G13	90	PCI_AD1	N10	65	PCI_FRAME	K1	29	VCC	L10	67
HAD8/GPD8	G10	92	PCI_AD2	K9	64	PCI_IDSEL	E1	12	VCC	J10	81
HAD9/GPD9	F13	93	PCI_AD3	M9	62	PCI_INTA	L6	50	VCC	F11	95
HAD10/GPD10	F12	94	PCI_AD4	N9	61	PCI_IRDY	K2	30	VCC	D10	113
HAD11/GPD11	F10	96	PCI_AD5	K8	60	PCI_LOCK	K4	41	VCC	D7	128
HAD12/GPD12	E13	97	PCI_AD6	L8	59	PCI_PAR	M3	39	VCCCH	G11	91
HAD13/GPD13	E12	98	PCI_AD7	M8	58	PCI_PCLK	H1	21	VCCCH	B8	123
HAD14/GPD14	E11	99	PCI_AD8	N7	54	PCI_PERR	N1	37	VCCP	G1	18
HAD15/GPD15	E10	100	PCI_AD9	M7	53	PCI_RST	G3	19	VCCP	L7	55

The terminals are grouped in tables by functionality, such as PCI system function, power-supply function, etc. The terminal numbers are also listed for convenient reference.

Table 2–3. Power Supply

TERMINAL			DESCRIPTION
NAME	NO.		
	PGE	GGU	
GND	10, 22, 31, 43, 51, 63, 77, 87, 101, 118	C9, D13, E3, H2, H12, K3, K10, L9, M4, M6	Device ground terminals
VCC	5, 13, 27, 40, 49, 57, 67, 81, 95, 113, 128	D4, D7, D10, F4, F11, J3, J10, K6, L10, N3, N8	Power supply terminal for core logic (3.3 V)
V _{CCH}	91, 123	G11, B8	HPI interface signaling voltage. The V _{CCH} input indicates the signaling level for the HPI interface and is nominally either 3.3 V or 5 V.
V _{CCP}	18, 55	G1, L7	PCI interface signaling voltage. The V _{CCP} input indicates the signaling level for the PCI interface and is nominally either 3.3 V or 5 V.

Table 2–4. PCI System Terminal Functions

TERMINAL			I/O	DESCRIPTION
NAME	NO.			
	PGE	GGU		
PCI_AD31	1	A1	I/O	32-bit multiplexed address/data bus
PCI_AD30	2	B1		
PCI_AD29	3	C2		
PCI_AD28	4	C1		
PCI_AD27	6	D3		
PCI_AD26	7	D2		
PCI_AD25	8	D1		
PCI_AD24	9	E4		
PCI_AD23	14	F3		
PCI_AD22	15	F2		
PCI_AD21	16	F1		
PCI_AD20	17	G2		
PCI_AD19	23	H3		
PCI_AD18	24	H4		
PCI_AD17	25	J1		
PCI_AD16	26	J2		
PCI_AD15	44	N4		
PCI_AD14	45	K5		
PCI_AD13	46	L5		
PCI_AD12	47	M5		
PCI_AD11	48	N5		
PCI_AD10	52	N6		
PCI_AD9	53	M7		
PCI_AD8	54	N7		
PCI_AD7	58	M8		
PCI_AD6	59	L8		
PCI_AD5	60	K8		
PCI_AD4	61	N9		
PCI_AD3	62	M9		
PCI_AD2	64	K9		
PCI_AD1	65	N10		
PCI_AD0	66	M10		
$\overline{\text{PCI_C/BE3}}$	11	E2		
$\overline{\text{PCI_C/BE2}}$	28	J4		
$\overline{\text{PCI_C/BE1}}$	42	L4		
$\overline{\text{PCI_C/BE0}}$	56	K7		
PCI_PCLK	21	H1	I	PCI clock. Provides timing for all PCI transactions with a maximum frequency of 33 MHz.
$\overline{\text{PCI_DEVSEL}}$	33	L2	O	Device select
$\overline{\text{PCI_FRAME}}$	29	K1	I	PCI cycle frame
PCI_IDSEL	12	E1	I	Initialization and device select
$\overline{\text{PCI_INTA}}$	50	L6	O	Interrupt A. $\overline{\text{INTA}}$ indicates to the host that PCI2040 requires attention.
$\overline{\text{PCI_IRDY}}$	30	K2	I	Initiator ready
$\overline{\text{PCI_LOCK}}$	41	K4	I	PCI lock
PCI_PAR	39	M3	I/O	PCI parity
PCI_PERR	37	N1	I/O	Parity error
$\overline{\text{PCI_RST}}$	19	G3	I	PCI reset. Assertion forces PCI2040 non-PME context to a predetermined state.
$\overline{\text{PCI_SERR}}$	38	N2	O	System error
$\overline{\text{PCI_STOP}}$	34	L3	O	PCI stop
$\overline{\text{PCI_TRDY}}$	32	L1	O	Target ready

Table 2–5. Miscellaneous Terminal Functions

TERMINAL			I/O	DESCRIPTION
NAME	NO.			
	PGE	GGU		
$\overline{\text{GRST}}$	20	G4	I	Global reset. This is a power-on reset to PCI2040 that indicates that a power has been applied to the V_{CC} terminals. $\overline{\text{GRST}}$ resets all register bits in PCI2040.
$\overline{\text{PME}}$	68	N11	O	Power management event. This output indicates PCI power management wake-up events to the host, and requires open-drain, fail-safe signaling per the <i>PCI Bus Power Management Interface Specification</i> .
GPIO5 GPIO4 GPIO3 GPIO2 GPIO1 GPIO0	130 129 127 126 125 124	B6 A6 C7 A7 B7 A8	I/O	<p>General-purpose inputs/output. With some exceptions, these terminals provide basic general-purpose input and output functionality programmable through the PCI2040.</p> <p>The GPIO3 and GPIO2 inputs may be programmed to generate generic interrupt events. See Section 3.7.4, <i>General-Purpose Interrupts</i>, for details.</p> <p>$\overline{\text{GPIO0}}$ is sampled on $\overline{\text{GRST}}$ to determine if a serial ROM is implemented. If GPIO0 is sampled high on $\overline{\text{GRST}}$ assertions, then the serial ROM clock (SCL) is routed to the GPIO0 terminal and the serial ROM data line (SDA) is routed to the GPIO1 terminal.</p> <p>GPIO4. GP write strobe. This active low signal is used to indicate a read from a device on the bus. The data on the bus is valid on the rising edge of $\overline{\text{WR}}$.</p> <p>GPIO5. GP read strobe. This active low signal is used to indicate a write to a device on the bus. The data on the bus is valid on the rising edge of $\overline{\text{RD}}$.</p>
RSVD	35, 36, 69, 131–144	A2–A5, B2–B5, C3–C6, D5, D6, M1, M2, M11	NC	Reserved. These terminals are not connected in PCI2040 implementations.

Table 2–6. Host Port Interface Terminal Functions

TERMINAL			I/O	DESCRIPTION
NAME	NO.			
	PGE	GGU		
HAD15 HAD14 HAD13 HAD12 HAD11 HAD10 HAD9 HAD8 HAD7 HAD6 HAD5 HAD4 HAD3 HAD2 HAD1 HAD0	100 99 98 97 96 94 93 92 90 89 88 86 85 84 83 82	E10 E11 E12 E13 F10 F12 F13 G10 G13 G12 H13 H11 H10 J13 J12 J11	I/O	Data. A 16-bit parallel, bidirectional, and 3-state data bus used to access registers on external devices controlled by PCI2040. HAD15 is MSB and HAD0 is LSB.
$\overline{\text{HR}}/\overline{\text{W}}/\text{GPA5}$	106	C11	O	Read/Write. The PCI2040 drives this signal to 0 on a host port interface for a write and to 1 on a host port interface for a read.
$\overline{\text{HDS}}/\overline{\text{GP}}/\overline{\text{CS}}$	112	A11	O	Read strobe/data strobe. Active low signal that controls the transfer of data during an HPI cycle, and indicates to the DSP that the data on HAD15–HAD0 is valid. This signal must be connected to HDS1 or HDS2 on the DSP. Unused DSP HDSx inputs must be tied high.
$\overline{\text{HINT3}}$ $\overline{\text{HINT2}}$ $\overline{\text{HINT1}}$ $\overline{\text{HINT0}}$	80 79 78 76	K13 K12 K11 L13	I	HPI Interrupts. These four interrupts from the DSPs are connected point-to-point between PCI2040 and each implemented DSP. The PCI2040 may be programmed to assert a PCI interrupt when the DSPs assert any $\overline{\text{HINT3}}$ – $\overline{\text{HINT0}}$. From the DSP perspective, these signals are controlled by the HINT bit in the HPI control register and are driven high when the DSPs are being reset (and placed in high impedance when EMU1/OFF is asserted).
$\overline{\text{HBE1}}/\text{GPA1}$ $\overline{\text{HBE0}}/\text{GPA0}$	110 111	A12 B11	O	Byte enables. These active low signals are only used when communicating with the C6x DSP. They indicate which bytes of the data bus are valid when writing to the C6x HPI data register and are not meaningful in any other conditions.
HWIL/GPA2	109	A13	O	Half-word identification select. Identifies first or second half-word of transfer. HWIL is low for the first half-word and high for the second half-word. This is not to be confused with the BOB bit in the DSP HPI control register which controls MSB/LSB from the DSP perspective.
HCNTL1/GPA4 HCNTL0/GPA3	107 108	B13 B12	O	Control signals for DSP access mode. Selects an access to DSP HPI address register, HPI control register, or HPI data register (and controls auto-increment). The HCNTL1 and HCNTL0 combinations are different for C54x and C6x DSPs.
$\overline{\text{HCS3}}$ $\overline{\text{HCS2}}$ $\overline{\text{HCS1}}$ $\overline{\text{HCS0}}$	105 104 103 102	C12 C13 D11 D12	O	Chip selects. These four chip selects to the DSPs are connected point-to-point between PCI2040 and each implemented DSP. The input to the DSP serves as an enable input for the HPI and must be low during an access and may stay low between accesses.
HRDY5x3/ $\overline{\text{HRDY6x3}}$ HRDY5x2/ $\overline{\text{HRDY6x2}}$ HRDY5x1/ $\overline{\text{HRDY6x1}}$ HRDY5x0/ $\overline{\text{HRDY6x0}}$	122 121 120 119	C8 D8 A9 B9	I	Host ready signals. These ready signals from the DSPs are connected point-to-point between PCI2040 and each implemented DSP. This ready signal is active high for C54x DSPs and active low for C6x DSPs. When asserted, it indicates that the DSP is ready for a transfer to be performed, and is deasserted when the DSP is busy completing the internal portion of the previous transaction. $\overline{\text{HCS}}$ enables HRDY for the DSP; that is, HRDY is always asserted when the chip selects are deasserted. The DSP places this ready signal in high impedance when EMU1/OFF is active (low).
$\overline{\text{HRST3}}$ $\overline{\text{HRST2}}$ $\overline{\text{HRST1}}$ $\overline{\text{HRST0}}$	117 116 115 114	D9 A10 B10 C10	O	Host-to-DSP resets. These active low reset signals to the DSPs are connected point-to-point between PCI2040 and each implemented DSP. The PCI2040 resets the DSPs when GRST is asserted. It is software's responsibility to deassert $\overline{\text{HRSTn}}$.

Table 2–7. Compact PCI Hot Swap Interface

TERMINAL			I/O	DESCRIPTION
NAME	NO.			
	PGE	GGU		
$\overline{\text{HSENUM}}$	71	N12	O	Hot swap ENUM. This is an active low open drain signaling output that is asserted when either bit 7 (INS) or bit 6 (EXT) are set and bit 1 (EIM) is cleared in the CPCI hot swap control and status register (see Section 4.35). This output indicates to the system that an insertion event occurred or that a removal event is about to occur.
HSLED	72	M12	O	Hot swap LED. This output is controlled via bit 3 (LOO) in the CPCI hot swap control and status register (see Section 4.35) and is provided to indicate when a hot-swap device is about to be removed. When $\overline{\text{PCI_RST}}$ is asserted to PCI2040, it drives this LED output until the serial ROM has completed preload and the ejector switch has been closed indicated by the HSSWITCH input.
HSSWITCH	73	N13	I	Hot swap handle switch. This input provides status of the ejector handle state and is used in the bit 7 (INS) and bit 6 (EXT) logic in the CPCI hot swap control and status register (see Section 4.35). The status of HSSWITCH is not directly read via CPCI hot swap control and status register but can be read through bit 8 (HSSWITCH_STS) in the miscellaneous control register (see Section 4.26).

Table 2–8. General-Purpose Bus Interface

TERMINAL			I/O	DESCRIPTION
NAME	NO.			
	PGE	GGU		
GPD15	100	E10	I/O	GP data bus. 16-bit data bus.
GPD14	99	E11		
GPD13	98	E12		
GPD12	97	E13		
GPD11	96	F10		
GPD10	94	F12		
GPD9	93	F13		
GPD8	92	G10		
GPD7	90	G13		
GPD6	89	G12		
GPD5	88	H13		
GPD4	86	H11		
GPD3	85	H10		
GPD2	84	J13		
GPD1	83	J12		
GPD0	82	J11		
GPA5	106	C11	I/O	GP address lines. 6-bit address bus.
GPA4	107	B13		
GPA3	108	B12		
GPA2	109	A13		
GPA1	110	A12		
GPA0	111	B11		
$\overline{\text{GP_CS}}$	112	A11	O	GP chip select
$\overline{\text{GP_INT}}$	74	M13	I/O	GP interrupt. Interrupt from a device on the GP bus.
$\overline{\text{GP_RD}}$	130	B6	I/O	GP read.
$\overline{\text{GP_RDY}}$	75	L12	I/O	GP ready. Whenever the device on the GP bus is ready to accept a read or write from PCI2040, $\overline{\text{GP_RDY}}$ is asserted. $\overline{\text{GP_RDY}}$ is deasserted when the device is in recovery from a read or write operation.
$\overline{\text{GP_RST}}$	70	L11	O	GP reset. An active low output that will follow the state of $\overline{\text{GRST}}$.
$\overline{\text{GP_WR}}$	129	A6	I/O	GP write.

3 PCI2040 Functional Description

This section covers the functional description for PCI2040. The PCI2040 provides a 32-bit PCI host interface and an interface for 8-bit and 16-bit host port interface (HPI) ports for TI's C54x and C6x families of DSP processors. The following conventions are used in this document:

- DSP C54x or C6x
- Word 16 bits for PCI, 16 bits for C54x, 32 bits for C6x
- Half-word 8 bits for C54x, 16 bits for C6x
- Double-word 32 bits for PCI

Figure 3–1 shows a simplified block diagram of the PCI2040.

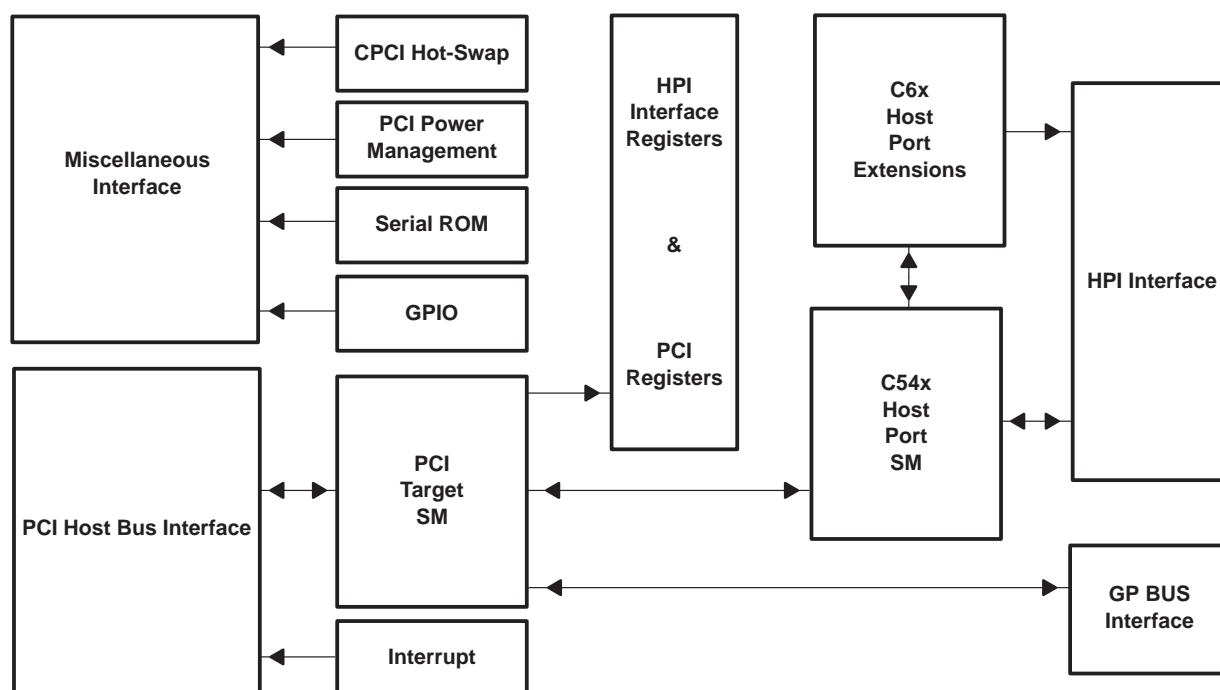

Figure 3–1. PCI2040 System Block Diagram

3.1 PCI Interface

PCI2040 provides an integrated 32-bit PCI bus interface compliant with the *PCI Local Bus Specification*. The PCI2040 incorporates a PCI target interface for configuration cycles, accesses to internal registers, and access to the HPI interface via memory-mapped space. The PCI2040 does not provide PCI mastering.

As a PCI bus target, PCI2040 incorporates the following features:

- Supports the memory read, memory write, configuration read, and configuration write
- Aliases the memory read multiple, memory read line, and memory write and invalidate to the basic memory commands (i.e., memory read and memory write)
- Supports $\overline{\text{PCI_LOCK}}$

3.2 Accessing Internal PCI2040 Registers

PCI configuration space is accessed via PCI configuration read and PCI configuration write cycles. These registers may be accessed using byte, word, or double-word transfers.

The PCI2040 provides a set of registers specifically for interfacing with the HPI port. These registers are called the HPI control and status registers (HPI CSRs) (see Section 5), and they may be memory- and I/O-mapped. The HPI CSR memory base address register (see Section 4.11) provides the mechanism for mapping the HPI CSRs into memory space. When mapped into memory space, the HPI CSRs may be accessed using bytes, words, or double-word transfers. Memory mapping the HPI CSR registers is recommended.

The HPI control and status registers may also be mapped into I/O space via the HPI CSR I/O base address register (see Section 4.32). When this register is programmed to a nonzero value, PCI2040 maps the HPI CSRs into I/O space, and the index/data access scheme is used to access the registers using byte transfers.

The HPI CSR I/O base address register identifies the I/O address of the index port. I/O address index + 1 is the data port. To access a HPI CSR register, software writes the offset of the HPI CSR register into the index port. I/O reads from the data port provide the contents of the indexed register and writes to the data port result in PCI2040 updating the indexed register.

3.3 $\overline{\text{PCI_LOCK}}$

PCI2040 supports exclusive access via the $\overline{\text{LOCK}}$ protocol defined by PCI and the $\overline{\text{PCI_LOCK}}$ terminal. As a PCI target, PCI2040 locks all DSP access and internal resources to a particular master when $\overline{\text{PCI_LOCK}}$ is sampled deasserted during the address phase of a PCI cycle that it claims. Once $\overline{\text{LOCK}}$ is established, the PCI2040 remains locked until both $\overline{\text{FRAME}}$ and $\overline{\text{LOCK}}$ are sampled deasserted or bit 30 (HPIError) is set in the interrupt event register (see Section 5.1).

The master that owns the exclusive access lock on PCI2040 drives $\overline{\text{PCI_LOCK}}$ while the lock is established and deasserts $\overline{\text{PCI_LOCK}}$ (and asserts $\overline{\text{FRAME}}$) when addressing the PCI2040. The PCI2040 claims and retries cycles addressed to it when $\overline{\text{PCI_LOCK}}$ is asserted. Other masters will not be able to force the $\overline{\text{PCI_LOCK}}$ signal high when addressing a locked PCI2040 and will be retried.

Note that when the PCI2040 is not locked, it can claim and complete data transfers even if $\overline{\text{PCI_LOCK}}$ is sampled asserted in the address phase.

3.4 Serial ROM Interface

The PCI2040 provides a two-wire serial ROM interface that may be used to preload PCI2040 registers following a power-on reset ($\overline{\text{GRST}}$). The serial ROM interface includes a serial clock (SCL) output and a serial data (SDA) input/output. The SCL signal maps to the GPIO0 terminal and the SDA signal maps to the GPIO1 terminal. The two-wire serial ROM interface is enabled by pulling up both GPIO0 and GPIO1 terminals to V_{CC} with resistors. The PCI2040 will only sense GPIO0 on $\overline{\text{GRST}}$ to identify the serial ROM; thus, only GPIO0 must be tied low to disable the serial ROM interface.

The registers that may be preloaded are given in the following list, and only write accessible bits in these registers may be preloaded. Figure 3–2 illustrates the PCI2040 serial ROM data format.

- Class code register : SubClass – SubClass
- Class code register : BaseClass – BaseClass
- Subsystem vendor ID register – SubSys Byte 0 & SubSys Byte 1
- Subsystem ID register – SubSys Byte 2 & SubSys Byte 3
- GPIO select register – GPIO select register
- Miscellaneous control register – Misc Ctrl Byte 0 & Misc Ctrl Byte 1

- Diagnostic register – Diagnostic
- HPI DSP implementation register – HPI_Imp Byte 0
- HPI data width register – HPI_DW Byte 0

SubClass	Word Address 0	RSVD	Word Address 16 (10h)
BaseClass	Word Address 1	RSVD	Word Address 17
SubSys Byte 0	Word Address 2	RSVD	Word Address 18
SubSys Byte 1	Word Address 3	RSVD	Word Address 19
SubSys Byte 2	Word Address 4	RSVD	Word Address 20
SubSys Byte 3	Word Address 5	RSVD	Word Address 21
GPIO Select	Word Address 6	RSVD	Word Address 22
RSVD	Word Address 7	RSVD	Word Address 23
RSVD	Word Address 8	RSVD	Word Address 24
Misc Ctrl Byte 0	Word Address 9	RSVD	Word Address 25
Misc Ctrl Byte 1	Word Address 10	RSVD	Word Address 26
Diagnostic	Word Address 11	RSVD	Word Address 27
HPI_Imp Byte 0	Word Address 12	RSVD	Word Address 28
RSVD	Word Address 13	RSVD	Word Address 29
HPI_DW Byte 0	Word Address 14	RSVD	Word Address 30
RSVD	Word Address 15	RSVD_DIAG	Word Address 31
		...AVAIL...	

Figure 3–2. PCI2040 Serial ROM Data Format

When PCI2040 accesses an implemented serial ROM, it always addresses the serial ROM at slave address 8'b10100000. The serial ROM data format described above utilizes 32 bytes of address space, some of which are reserved for future generations of the PCI2040. A byte at address 31 is reserved for diagnostic software purposes and will not be allocated to future generations of the PCI2040. Serial ROM addresses above word address 31 are available for use by PCI2040 applications. If the data at word address 0 is FFh, then the PCI2040 will stop reading from the serial ROM. This feature prevents the uninitialized data from being loaded into the PCI2040's registers.

3.5 PCI2040 Host Port Interface

The PCI2040 HPI interface is used to access TI's TMS320C54X or TMS320C6X DSP chips. The devices connected to the HPI interface are memory-mapped in host memory. The host system processor accesses the HPI interface via slave accesses to PCI2040. The DSP devices can generate interrupts, and the PCI2040 passes these interrupt requests to the PCI bus via $\overline{\text{INTA}}$. See Section 3.7, *Interrupts*, for more information on PCI2040 interrupts.

The HPI port on DSP devices is a parallel port that allows access to the DSP's memory space and internal registers. The PCI2040 has to configure the HPI interface on the DSP by accessing the DSP's HPI control register (HPIC). Other DSP HPI registers include the HPI data register (HPID) and the HPI address register (HPIA). See Section 6, *DSP HPI Overview* for more information on DSP registers.

3.5.1 Identifying Implemented Ports and DSP Types

The PCI2040 supports up to four DSPs of both the C54x and C6x types. It may be useful for generic software to discover what number and type of DSPs are connected to the PCI2040. This is accomplished by using the HPI DSP implementation register (see Section 5.5) and HPI data width register (see Section 5.6) in the HPI control and status register space. The HPI DSP implementation register identifies how many DSPs are implemented and what $\overline{\text{HCSn}}$ outputs are connected, and the HPI data width register identifies whether the HPI port per connected DSP is 8 bits (C54x) or 16 bits (C6x).

The HPI DSP implementation register and HPI data width register may be loaded from a serial ROM. Also, these registers are implemented as read/write so intelligent software can load them with the proper values.

3.5.2 DSP Chip Selects

The PCI2040 provides four chip select outputs ($\overline{\text{HCS3}}$ – $\overline{\text{HCS0}}$) that uniquely select each HPI port DSP (or other HPI peripheral) per transaction. This section describes how software encodes the chip select in the PCI address to access a particular DSP interfacing with PCI2040.

The PCI2040's control space base address register (see Section 4.12) is a standard PCI base address register requesting 32K bytes of control space nonprefetchable memory to access up to four DSPs. The PCI2040 claims PCI memory access transactions that fall within the 32-Kbyte memory window by comparing the upper 17 bits of the PCI address (PCI_AD31–PCI_AD15) to bits 31–15 (AVAIL_ADD field) in the control space base address register. When a cycle is claimed, the chip select is determined by decoding bits 14 and 13 of the PCI address. PCI_AD14 and PCI_AD13 determine the chip select according to Table 3–1.

Only when the PCI cycle is claimed (by decoding PCI_AD31–PCI_AD15) is the chip select asserted.

Table 3–1. PCI2040 Chip Select Decoding

PCI_AD(14–13)	CHIP SELECT ASSERTED
2'b00	$\overline{\text{HCS0}}$
2'b01	$\overline{\text{HCS1}}$
2'b10	$\overline{\text{HCS2}}$
2'b11	$\overline{\text{HCS3}}$

3.5.3 HPI Register Access Control

The HCNTL1 and HCNTL0 terminals are driven by the PCI2040 to select the DSP HPI register and access mode on a cycle-by-cycle basis. The PCI2040 determines the type of DSP register access from the PCI address, similarly to the chip select decode as described in Section 3.5.2, *DSP Chip Selects*.

When a cycle is claimed by decoding PCI_AD31–PCI_AD15, the HCNTL1 and HCNTL0 control signals are determined by decoding bits 12 and 11 of PCI address. PCI_AD12 maps to HCNTL1 and PCI_AD11 maps to HCNTL0, and the selected HCNTL1 and HCNTL0 are driven to the HPI interface when the cycle is forwarded.

Table 6–1 and Table 6–3 provides more information on the usage of HCNTL1 and HCNTL0 for both C54x and C6x DSPs.

3.5.4 Mapping HPI DSP Memory to the Host

The PCI address bits PCI_AD10–PCI_AD0 are not forwarded to the HPI interface, and these address bits are not decoded by PCI2040 for any purpose. This 2-Kbyte of addressable space per DSP (and control) allows the host to directly map 2K bytes of host memory to the HPI interface for each DSP. This allows for fast memory block copies rather than an I/O port mechanism.

The PCI2040 does not automatically generate accesses to the HPI address registers based upon PCI_AD10–PCI_AD0, and it is left to software to synchronize the HPI address register with copies to and from HPI memory space.

3.5.5 Read/Write Procedure

The following procedure illustrates how to read and write HPI space, and covers some of the initialization that must be done to successfully transfer data to and from DSP memory via the HPI data register.

After a power-on reset ($\overline{\text{GRST}}$):

- PCI2040 preloads several registers if a serial ROM is implemented, and this rewrites the HPI implementation and HPI data width registers (software can also rewrite these registers).

- HPI CSR memory base address register (see Section 4.11) is programmed to provide a pointer to the HPI control and status registers (see Section 5). HPI CSR I/O base address register (see Section 4.32) can also be programmed to give I/O access.
- Control space base address register (see Section 4.12) is programmed and 32K bytes of memory are allocated.
- The PCI command register (see Section 4.3) is programmed to allow PCI2040 to respond to memory and I/O cycles.
- Software must clear the HPI reset register (see Section 5.4) to remove the reset assertion to the DSPs.
- When PCI2040 decodes a PCI address within the 32-Kbyte memory control space window, it claims the cycle and decodes the chip select, HCNTL1 and HCNTL0, to pass to the HPI interface.
- The host initializes the BOB or HWOB bit in the HPI control register (see Section 6.2 or Section 6.3.5, respectively) to choose the correct byte alignment. This results in an HPI cycle to the DSP's HPI control register.
- The host then initializes the HPI address register with the correct HPI memory address. By loading the HPI address register, an internal DSP HPI memory access is initiated and the data is latched in the HPI data register.
- If this is a read:
 - The host performs a read of the HPI data register. During the read, the contents of the first half-word data latch appear on the HADn pins when the HWIL signal is low and contents of the second data latch when the HWIL signal is high.
 - If auto-increment is selected, then it occurs between the transfer of the first and second bytes. This allows back-to-back HPI data register accesses without an intervening HPI address register access.
- If this is a write:
 - The first data latch of HPI data register is written from the data coming from the host while HWIL is low and the second data latch when HWIL is high. If communicating with C6x, then the correct combination of byte enables must also be used.
 - If auto-increment is selected, then it occurs between the transfer of the first and second bytes.

3.5.6 HPI Interface Specific Notes

The PCI2040 supports the HPI features from C54x and C6x interfaces given in Table 3–2. See Section 6, *DSP HPI Overview*, and the *HPI functional specification* and timing requirements for more details.

Table 3–2. HPI Interface Features

C54x	C6x
Shared access mode (SAM) and host only mode (HOM)	Only one mode of operation: host only mode (HOM)
Auto-increment	Auto-increment
Endian byte swap (BOB)	Endian byte swap (HWOB)
DSP-to-host interrupt	DSP-to-host interrupt
Wait states using $\overline{\text{HRDY}}5\text{xn}$	Wait states using $\overline{\text{HRDY}}6\text{xn}$
Two data strobes: $\overline{\text{HDS}}$, $\overline{\text{HR}}/\overline{\text{W}}$	Two data strobes: $\overline{\text{HDS}}$, $\overline{\text{HR}}/\overline{\text{W}}$
HPI memory access during reset	Byte enables
	No software handshaking using $\overline{\text{HRDY}}$ and $\overline{\text{FETCH}}$
Valid byte enables	All byte enables valid

3.6 General-Purpose I/O Interface

The PCI2040 has six general-purpose input/output (GPIO) terminals for design flexibility, and these terminals reside in the V_{CCP} signaling environment. GPIO5–GPIO0 default to inputs, but may be programmed to be outputs via the GPIO direction control register (see Section 4.23). When GPIOx is selected as an input, the logical value of the data input on GPIOx is reported through the GPIO input data register (see Section 4.22). When GPIOx is selected as an output, the logical value of the data driven by PCI2040 to the GPIOx terminal is programmed via the GPIO output data register (see Section 4.24). The GPIO input data register, GPIO output data register, and GPIO direction control register are only meaningful for GPIOx if GPIOx is selected as a general-purpose input/output through the GPIO select register (see Section 4.21).

Through the GPIO select register, the GPIO5–GPIO0 terminals may be programmed to other signal functions, such as test outputs and general-purpose interrupt event inputs. See Section 4.21, *GPIO select register*, for more details on these options.

If bit 5 in the miscellaneous control register is set to 1 (see Section 4.26), then GPIO5 and GPIO4 provide some signals from the general-purpose bus interface. Also note that GPIO0 and GPIO1 provide the serial ROM interface if enabled as described in Section 3.4, *Serial ROM Interface*.

3.7 Interrupts

The PCI2040 reports two classes of interrupts: DSP interrupts and device interrupts. DSP interrupts are generated when an implemented DSP asserts its \overline{HINTn} signal, and device interrupts come directly from the remaining PCI2040 logic. For example, one such PCI2040 device interrupt indicates that a serious error has occurred on the HPI interface.

3.7.1 Interrupt Event and Interrupt Mask Registers

The PCI2040 contains two 32-bit registers to report and control interrupts: interrupt event register (see Section 5.1) and interrupt mask register (see Section 5.2). These registers exist in the HPI control and status register space. Both registers have two addresses: a set address and a clear address. For a write to either register, a 1 written to the set address causes the corresponding bit in the register to be set (excluding bits that are read-only), while a 1 written to the clear address causes the corresponding bit to be cleared. For both addresses, writing a 0 has no effect on the corresponding bit in the register.

The interrupt event register contains the actual PCI2040 interrupt request bits, and the response to these sources can be tested by diagnostic software by setting the corresponding bit in the interrupt event set register. The interrupt mask register is AND'ed with the interrupt event register to enable selected sources to generate host interrupts through \overline{INTA} . Software writes to the interrupt event clear register to clear interrupt conditions reported in the interrupt event register.

Reading either the set or the clear address for these registers returns the value of the register with one exception. Reading the interrupt event clear register returns the value of the interrupt event register AND'ed with the interrupt mask register to report the unmasked bits that are set in the interrupt event register that caused the interrupt event. Software can then write this value to the interrupt event clear register, which clears the events causing the interrupt, and the PCI2040 deasserts \overline{INTA} if no more unmasked interrupt events are pending.

PCI2040 also implements a global interrupt enable in the interrupt mask register at bit 31 (masterIntEnable). Only when bit 31 is set will the PCI2040 generate an \overline{INTA} .

3.7.2 DSP-to-Host Interrupts

These interrupts are the most common interrupts generated by the PCI2040. The four interrupt events, IntDSP3–IntDSP0 (bits 3–0 in Section 5.2), occur when the corresponding $\overline{HINT3}$ – $\overline{HINT0}$ is asserted by the DSP. When enabled via the corresponding bits in the interrupt mask register (see Section 5.1), these DSP interrupts are passed directly to the PCI host.

As a side note, $\overline{\text{HINT}}$ is generated when the HINT bit is set in the HPI control register. See Section 6, *DSP HPI Overview*, for a description of the DSPs HPI control register.

3.7.3 HPI Error Interrupts and HPI Error Reporting

Bit 30 (HPIError) in the interrupt event register (see Section 5.1), set upon serious error conditions on the HPI interface, allows software to gracefully terminate communication with an HPI device. Bit 30 is set when any of the bits in the HPI error report register (see Section 5.3) are set (an OR combination).

Bits 3–0 (HPIErr[3:0] field) in the HPI error report register (see Section 5.3) are set for an HPI interface when a cycle destined for a particular interface experienced as serious error, which may be a result of a DSP losing power. Such error conditions are as follows:

1. HRDY5xn (or $\overline{\text{HRDY6xn}}$) driven by DSP is not asserted within 256 PCI clock cycles following assertion of $\overline{\text{HCSn}}$. This timer can be disabled by setting bit 1 (ErrorTimer) in the diagnostic register (see Section 4.27).
2. The discard timeout expires for a read transaction from HPI(x)
3. A PCI byte enable combination other than 4'b1100, 4'b0011, or 4'b0000 was received for a transaction destined for a C54x DSP on HPI(x)

To avoid potential system level catastrophe when the PCI target abort is signaled, PCI2040 implements a feature to disable target aborts and returns zero data on such error conditions. This mode of operation is enabled via bit 30 (HPIError) in the interrupt mask register (see Section 5.2). When bit 31 is set and bit 30 (HPIError) in the interrupt event register is also set, on all HPI error conditions, an $\overline{\text{INTA}}$ interrupt is signaled.

Also when bit 30 (HPIError) in the interrupt mask register is set, error on posted writes will not cause the $\overline{\text{SERR}}$ signal assertion by bit 8 (SERR_EN) in the PCI command register (see Section 4.3). When bit 30 (HPIError) is 0, target aborts may occur and $\overline{\text{SERR}}$ may be signaled as a result of a posted write error. This mode of operation is not related to $\overline{\text{SERR}}$ signaling on PCI address parity errors per the *PCI Local Bus Specification*.

Future generations of PCI2040 may support connections to different numbers of DSPs (more or less than 4). A recommended procedure for software to determine the maximum number of DSP HPI connections is to write all 1s to the HPI error report register and read back the number of set bits. Similarly, software can perform the same procedure on the lower 16 bits of the interrupt mask or interrupt event register.

3.7.4 General-Purpose Interrupts

The GPIO3 and GPIO2 terminals may be configured via the GPIO select register (see Section 4.21) as general interrupt event inputs. The general interrupt event type may be either input low signal or input state change, and is programmable via the GPIO interrupt event type register (see Section 4.25). When these general interrupt events occur, the corresponding bits 28 (IntGPIO3) and 27 (IntGPIO2) are set in the interrupt event register (see Section 5.1) and may be enabled to generate an interrupt ($\overline{\text{INTA}}$) via interrupt mask register (see Section 5.2).

3.7.5 Interrupts Versus PME

When an unmasked interrupt event occurs and PCI2040 is in the D0 power state, PCI2040 asserts $\overline{\text{INTA}}$ to signal the interrupt event. When PCI2040 is in D1, D2, or D3, $\overline{\text{INTA}}$ generation is disabled regardless of the value of bit 31 (masterIntEnable) in the interrupt mask register (see Section 5.2).

Whenever an unmasked interrupt event occurs and bit 15 (PME_STS) in the power management control/status register is set (see Section 4.31), a $\overline{\text{PME}}$ power management event is generated if bit 8 (PME_EN) in the power management control/status register is set.

3.8 PCI2040 Power Management

This section covers the power management aspects of PCI2040, including descriptions of power savings features.

3.8.1 PCI Power Management Register Interface

PCI2040 is *PCI Bus Power Interface Management Specification* Revision 1.0 and 1.1 compliant. By default, PCI2040 provides the PCI power management PM 1.0 register set which is documented in Section 4.30. PCI2040 may be programmed to provide a PCI PM 1.1 register set by setting bit 4 (PM11_EN) of the miscellaneous control register to 1 (see Section 4.26).

The PCI power management register changes required to provide PCI PM 1.1 compliance to the power management capabilities register (see Section 4.30) are summarized in Table 3–3.

Table 3–3. PMC Changes for PCI PM 1.1 Register Model

BIT	FIELD NAME	TYPE	DESCRIPTION
15–9	PM 1.0 Compliant		Same as PM 1.0 Implementation. No change.
8–6	Aux_Current	R	Aux_Current. This field reports the Vaux requirements for PCI2040. If bit 15 (D3cold_PMESupport) in the power management capabilities register is set (see Section 4.30), then this field returns 3'b001 indicating that PCI2040 draws a maximum of 55 mA while programmed to D3. If bit 15 (D3cold_PMESupport) is 0, then this field returns 3'b000 since no wake from D3 _{cold} is supported. Bit 6 is aliased to bit 15 and is read-only.
5	PM 1.0 Compliant	R	Same as PM 1.0 Implementation. No change.
4	RSVD	R	This reserved field returns 0 when read in the PCI PM 1.1 register model and returns 1 when read in the PCI PM 1.0 model.
3	PM 1.0 Compliant	R	Same as PM 1.0 Implementation. No change.
2–0	Version	R	These three bits return 010b when read, indicating that there are 4 bytes of general-purpose power management (PM) registers as described in the draft revision 1.1 <i>PCI Bus Power Management Interface Specification</i> .

3.8.2 PCI Power Management Device States and Transitions

PCI2040 supports all D0–D3 device power states, and can assert $\overline{\text{PME}}$ from any power state including D3_{cold} when Vaux is supplied. The PCI2040's power state implementation is simply disabling the HPI state machine when in the D1, D2, or D3 power states. D0 is the fully operational power state.

If an HPI cycle initiated by PCI2040 is in progress when bits 1 and 0 (PWRSTATE field) in the power management control/status register are programmed to D1, D2, or D3 (see Section 4.31), then the PCI2040 will complete the cycle in progress before transitioning to the lower power state.

On a transition to the D0 power state from the D3 power state, PCI2040 asserts an internal signal equivalent to a $\overline{\text{PCI_RST}}$ which does not reset all internal states. There are several register bits that are reset by $\overline{\text{GRST}}$ versus the $\overline{\text{PCI_RST}}$, and these are referred to as the $\overline{\text{PME}}$ context (or sometimes sticky) bits.

The $\overline{\text{PME}}$ context bits for PCI2040 are listed below and Figure 3–3 illustrates the relationship between the $\overline{\text{PME}}$ context bits: $\overline{\text{GRST}}$, and $\overline{\text{PCI_RST}}$. The addition of $\overline{\text{GRST}}$ allows for retaining device state from a D3 to D0 transition when the PCI interface may transition from B3 to B0 and issue a PCI reset.

PCI2040 $\overline{\text{PME}}$ context bits for PCI space:

- 0x0A – SubClass Code register (all implemented bits)
- 0x0B – BaseClass Code register (all implemented bits)
- 0x2C – Subsystem vendor ID register (all implemented bits)
- 0x2E – Subsystem ID register (all implemented bits)
- 0x44 – GPIO select register (all implemented bits)
- 0x46 – GPIO direction control register (all implemented bits)
- 0x47 – GPIO output data register (all implemented bits)

- 0x48 – GPIO interrupt type register (all implemented bits)
- 0x4C – Miscellaneous control register (all implemented bits)
- 0x4C – Diagnostic register (all implemented bits)
- 0x52 – Power management capabilities register (D3cold_PME_Support)
- 0x54 – Power management control/status register (PMCSR.PME_STS, PMCSR.PME_ENB)

PCI2040 $\overline{\text{PME}}$ context bits for HPI CSR space:

- 0x00 / 0x04 – Interrupt event register (all implemented bits)
- 0x08 / 0x0C – Interrupt mask register (all implemented bits)
- 0x10 – HPI error report register (all implemented bits)
- 0x14 – HPI reset register (all implemented bits)
- 0x16 – HPI implementation register (all implemented bits)
- 0x18 – HPI data width register (all implemented bits)

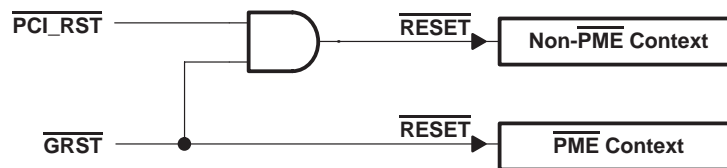

Figure 3-3. PCI2040 Reset Illustration

3.9 Compact PCI Hot-Swap

PCI2040 is hot-swap friendly silicon that will support all the hot-swap capable features, contain support for software control, and integrate circuitry required by the *Compact PCI Hot Swap Specification PICMG 2.1*. To be hot-swap capable, PCI2040 supports the following:

- *PCI Local Bus Specification, Revision 2.1* compliance
- V_{CC} from early power tolerant
- Asynchronous reset
- Precharge voltage tolerant
- I/O buffers must meet modified V/I requirements
- Limited I/O pin voltage at precharge voltage
- Hot swap control and status programming via extended PCI capabilities linked list
- Hot swap terminals: $\overline{\text{HSENUM}}$, HSSWITCH, and HSLED

CPCI hot-swap defines a process for installing and removing PCI boards without adversely affecting a running system. The PCI2040 provides this functionality such that it can be implemented on a board that can be removed and inserted in a hot-swap system.

The PCI2040 provides three terminals to support hot-swap: $\overline{\text{HSENUM}}$ (output), HSSWITCH (input), and HSLED (output). The $\overline{\text{HSENUM}}$ output indicates to the system that an insertion event occurred or that a removal event is about to occur. The HSSWITCH input indicates that state of a board ejector handle, and the HSLED output lights a blue LED to signal insertion and removal ready status.

The PCI2040 hot-swap functionality is controlled via the CPCI hot swap control and status register (see Section 4.35) in extended PCI configuration space. This register provides four bits for control: bit 7 (INS), bit 6 (EXT), bit 3 (LOO),

and bit 1 (EIM). Since no HSSWITCH status is provided in the CPCI hot swap control and status register, PCI2040 provides bit 8 (HSSWITCH_STS) in the miscellaneous control register (see Section 4.26).

$\overline{\text{HSENUM}}$ is an active low open drain output that is asserted when either bit 7 (INS) or bit 6 (EXT) are set and bit 1 (EIM, the $\overline{\text{HSENUM}}$ mask bit) is cleared. For the insertion event, PCI2040 will drive HSLED after PCI_RST until the serial ROM preload is complete and the ejector handle is closed (HSSWITCH_STS is 0). When these conditions are met, the HSLED is under software control via bit 3 (LOO). Bit 7 (INS) is set when the conditions described above are met and bit 6 (EXT) is 0. Thus, bit 7 (INS) is set following an insertion when the board implementing PCI2040 is ready for configuration and cannot be set by software.

For the removal event, bit 6 (EXT) is set when the ejector handle is opened (HSSWITCH_STS is 1) and bit 7 (INS) is 0. This will cause $\overline{\text{HSENUM}}$ to be asserted if bit 1 (EIM) is 0, and software will halt connection with PCI2040 and light the LED via bit 3 (LOO). The board may then be safely removed.

See the *Compact PCI Hot Swap Specification PICMG 2.1* for more details.

3.10 General-Purpose Bus

This section discusses the general-purpose interface of PCI2040. This is a 16-bit data and a 6-bit address bus. The 6-bit address bus is mapped directly to PCI address bits 7–2. This means that each address on the GP bus corresponds to a 32-bit (1 DW) address on the PCI bus for a total of 256 bytes of addressable space. Because the GP bus is only a 16-bit data bus, only the lower 16 bits (15–0) of the PCI data bus is used. In other words, the only valid byte enable combination is 1100b.

The general-purpose bus read/write strobes must default to the JTAG TBC (8990) timing requirements. However, $\overline{\text{GP_RDY}}$ signal can be used to extend the use of the bus for slower devices.

Most of the GP bus signals are multiplexed onto the HPI bus as described in the table below. In addition to the multiplexed signals, there are three dedicated GP bus signals which are $\overline{\text{GPINT}}$, $\overline{\text{GPRDY}}$, and $\overline{\text{GPRST}}$.

Table 3–4. General-Purpose Bus Signals

HPI SIGNALS	GP BUS SIGNALS	TYPE	NOTES
HAD15–HAD0	GP_DATA15–GP_DATA0	I/O	GP data bus. A 16-bit data bus
$\overline{\text{HBE0}}$	GPA0	O	One of the six address lines
$\overline{\text{HBE1}}$	GPA1	O	One of the six address lines
HWIL	GPA2	O	One of the six address lines
HCNTL0	GPA3	O	One of the six address lines
HCNTL1	GPA4	O	One of the six address lines
$\overline{\text{HR/W}}$	GPA5		One of the six address lines
$\overline{\text{HDS}}$	$\overline{\text{GP_CS}}$	O	GP chip select. This signal is asserted during an access on the GP bus.
GPIO5	$\overline{\text{GP_RD}}$	O	GP read strobe. This active low signal indicates a read from a device on the bus. The data on the bus is valid on the rising edge of $\overline{\text{GP_RD}}$.
GPIO4	$\overline{\text{GP_WR}}$	O	GP write strobe. This active low signal indicates a write to a device on the bus. The data on the bus is valid on the rising edge of $\overline{\text{GP_WR}}$.
Terminal 74	$\overline{\text{GP_INT}}$	I	GP interrupt. Interrupt from a device on the GP bus.
Terminal 75	$\overline{\text{GP_RDY}}$	I	GP ready. Whenever the device on the GP bus is ready to accept a read or write from PCI2040, $\overline{\text{GP_RDY}}$ is asserted. $\overline{\text{RDY}}$ is deasserted when the device is in recovery from a read or write operation.
Terminal 70	$\overline{\text{GP_RST}}$	O	GP reset. An active low output that follows the state of $\overline{\text{GRST}}$.

3.11 Example Transactions on the General-Purpose Bus

This section describes some example transactions on the GP bus.

3.11.1 General-Purpose Bus Word Write

The first diagram, Figure 3–4, depicts a word (16–bits) write to a device residing on the GP bus. The event flow is as follows:

1. All signals are in a deasserted state except for $\overline{\text{GP_RDY}}$. The PCI2040 is driving the address and data bus to a stable but unknown value.
2. The $\overline{\text{GP_CS}}$ is driven low. The data bus (GPD15–GPD0) is driven with the data the PCI2040 obtained from the PCI bus. In this case, the data is BBAAh. The address bus (GPA5–GPA0) is driven with the address the PCI2040 obtained from the PCI bus. For example, if the address on the PCI bus is FF0B0h, then this address would translate to a GP bus address of 2Ch.
3. The $\overline{\text{GP_WR}}$ strobe is driven low indicating a write to the device on the GP bus.
4. The $\overline{\text{GP_WR}}$ strobe is driven high. Typically, a device on the GP bus latches the data on the rising edge of the $\overline{\text{GP_WR}}$ strobe. But as the figure shows, the data is valid on both the falling edge and the rising edge of the write strobe. The PCI2040 samples the $\overline{\text{GP_RDY}}$ signal before it deasserts the $\overline{\text{GP_WR}}$ strobe. In this case, the $\overline{\text{GP_RDY}}$ signal is low indicating to the PCI2040 that the device is ready for data.
5. The transaction completes by deasserting the $\overline{\text{GP_CS}}$.

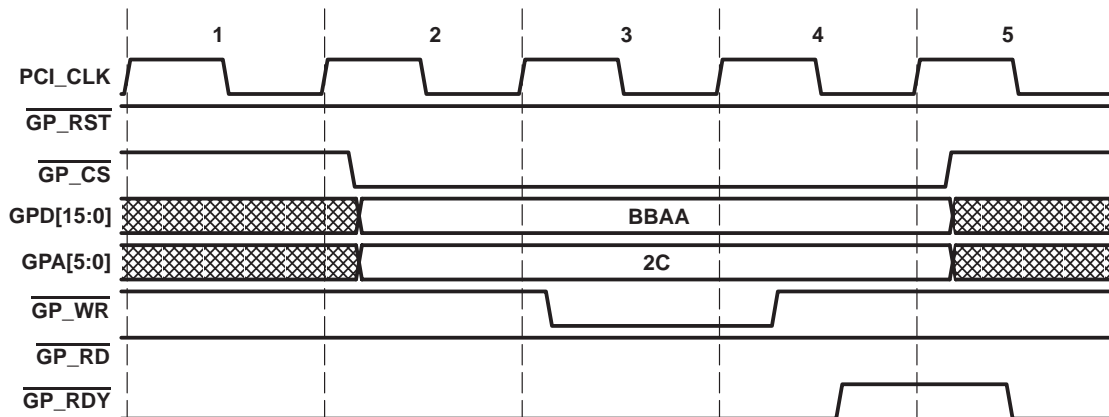

Figure 3–4. General-Purpose Bus Word Write

3.11.2 General-Purpose Bus Word Read

The second diagram, Figure 3–5, shows a word read from a device on the GP bus. The event flow is as follows:

1. All signals are in a deasserted state except for $\overline{\text{GP_RDY}}$. The PCI2040 is driving the address and data bus to a stable but unknown value.
2. The $\overline{\text{GP_CS}}$ is driven low. The data bus (GPD15–GPD0) is placed in a high impedance state. The address bus is driven with the address the PCI2040 obtained from the PCI bus.
3. The $\overline{\text{GP_RD}}$ strobe is driven low indicating a read to the device on the GP bus. Sometime later during clock 3, the device on the GP bus drives valid data on the data bus.
4. The $\overline{\text{GP_RD}}$ strobe is driven high. The PCI2040 samples the $\overline{\text{GP_RDY}}$ before it deasserts $\overline{\text{GP_RD}}$. If $\overline{\text{GP_RDY}}$ is sampled asserted, then the PCI2040 deasserts $\overline{\text{GP_RD}}$ strobe and latches the data on the GP bus. If $\overline{\text{GP_RDY}}$ is sampled deasserted, then the PCI2040 keeps $\overline{\text{GP_RD}}$ asserted and waits for the $\overline{\text{GP_RDY}}$ strobe to be asserted before it deasserts the $\overline{\text{GP_RD}}$ strobe.

- The transaction completes by deasserting the $\overline{\text{GP_CS}}$. The PCI2040 starts driving the GP address and data bus with stable values.

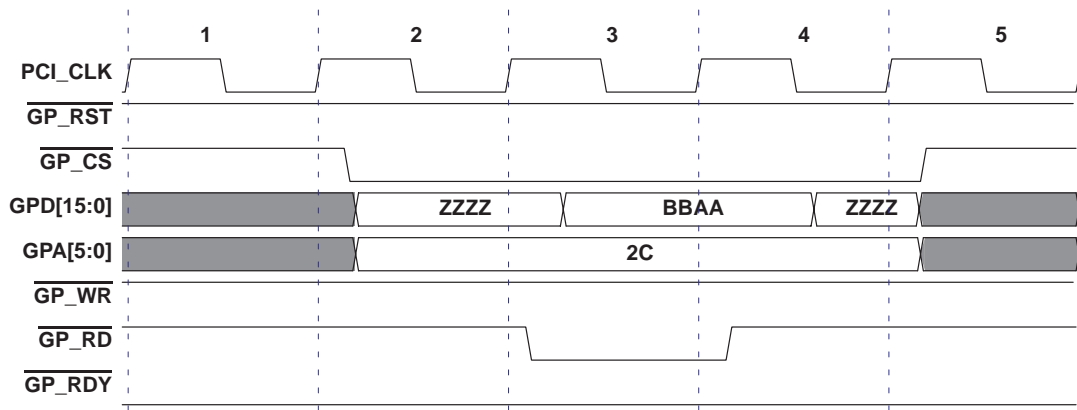

Figure 3–5. General-Purpose Bus Word Read

4 PCI2040 Programming Model

This section describes the PCI2040 PCI configuration registers that make up the 256-byte PCI configuration header. A brief description is provided for each register, followed by the register offset and a default state for each register. The bit table also has reserved fields that contain read-only reserved bits. These bits return 0s when read.

4.1 PCI Configuration Registers

The PCI2040 is a device that interfaces the PCI bus to the 8-bit or 16-bit HPI port of Texas Instruments C54x or C6x family of DSP processors. The configuration header is compliant with the *PCI Local Bus Specification*.

The configuration header is compliant with the *PCI Local Bus Specification* as a type 0 bridge header, and is PC98/99 compliant as well. Table 4–1 shows the PCI configuration header, which includes both the predefined portion of the configuration space and the user-definable registers.

Table 4–1. PCI Configuration Registers

REGISTER NAME				OFFSET
Device ID		Vendor ID		00h
Status		Command		04h
Class code			Revision ID	08h
BIST	Header type	Latency timer	Cache line size	0Ch
HPI CSR memory base address				10h
Control space base address				14h
GPBus base address				18h
Reserved				1Ch
Reserved				20h
Reserved				24h
Reserved				28h
Subsystem ID		Subsystem vendor ID		2Ch
Reserved				30h
Reserved	Reserved	Reserved	Capability pointer	34h
Reserved				38h
Max_Lat	Min_GNT	Interrupt pin	Interrupt line	3Ch
Reserved		Reserved		40h
GPIO output data	GPIO direction control	GPIO input data	GPIO select	44h
Reserved	Reserved	Reserved	GPIO interrupt type	48h
Diagnostic	Reserved	Miscellaneous control		4Ch
Power management capabilities		PM next-item pointer	PM capability ID	50h
Reserved		PM control/status		54h
HPI CSR I/O base address				58h
Reserved	HS_CSR	HS next-item pointer	HS capability ID	5Ch
Reserved	Reserved	Reserved	Reserved	60h
Reserved				64h–FFh

NOTE: Optional registers not implemented for PCI2040 return 0s when read.

A bit description table is typically included that indicates bit field names, a detailed field description, and field access tags. Table 4–2 describes the field access tags.

Table 4–2. Bit Field Access Tag Descriptions

ACCESS TAG	NAME	MEANING
R	Read	Field may be read by software.
W	Write	Field may be written by software to any value.
S	Set	Field may be set by a write of 1. Writes of 0 have no effect.
C	Clear	Field may be cleared by a write of one. Writes of 0 have no effect.
U	Update	Field may be autonomously updated by PCI2040.

4.2 Vendor and Device ID Register

The vendor and device ID register returns AC60104Ch when read which consists of a unique device ID assigned by TI (AC60h) and a value assigned by the PCI SIG to Texas Instruments (104Ch).

Bit	31	30	29	28	27	26	25	24	23	22	21	20	19	18	17	16
Name	Device ID															
Type	R	R	R	R	R	R	R	R	R	R	R	R	R	R	R	R
Default	1	0	1	0	1	1	0	0	0	1	1	0	0	0	0	0
Bit	15	14	13	12	11	10	9	8	7	6	5	4	3	2	1	0
Name	Vendor ID															
Type	R	R	R	R	R	R	R	R	R	R	R	R	R	R	R	R
Default	0	0	0	1	0	0	0	0	0	1	0	0	1	1	0	0

Register: **Vendor and device ID**
 Type: Read-only
 Offset: 00h
 Default: AC60104Ch

4.3 PCI Command Register

The system software accesses the status and command registers for error recovery, diagnostic, and control. This register is provided to enable coarse control over a device's ability to generate and respond to PCI cycles.

Bit	15	14	13	12	11	10	9	8	7	6	5	4	3	2	1	0
Name	PCI command															
Type	R	R	R	R	R	R	R	RW	R	RW	R	R	R	R	RW	RW
Default	0	0	0	0	0	0	0	0	0	0	0	0	0	0	0	0

Register: **PCI command**
 Type: Read-only, Read/Write
 Offset: 04h
 Default: 0000h

Table 4–3. PCI Command Register

BIT	FIELD NAME	TYPE	DESCRIPTION
15–10	RSVD	R	Reserved. Bits 15–10 return 0s when read.
9	FBB_EN	R	Fast back-to-back (FBB) enable. This bit controls whether or not the device is allowed to perform back-to-back capability for bus master transaction. This bit is hardwired to 0 and indicates that FBB transfers are not supported by PCI2040.
8	SERR_EN	RW	System error ($\overline{\text{SERR}}$) enable. This bit is an enable for the output driver on the $\overline{\text{SERR}}$ pin. If this bit is cleared and a system error condition is set inside PCI2040, then the error signal will not appear on the external SERR pin.
7	STEP_EN	R	Address/data stepping control. This bit indicates whether or not the device performs address stepping. Since the PCI2040 does not require address stepping, this bit is hardwired to 0.
6	PERR_EN	RW	Parity error response enable. This bit controls whether or not the device responds to detected parity errors. If this bit is set, then the PCI2040 responds normally to parity errors. If this bit is cleared, then the PCI2040 ignores detected parity errors.
5	VGA_EN	R	VGA palette snoop. This bit is not applicable for PCI2040 and is hardwired to a 0.
4	MWI_EN	R	Memory write and invalidate enable. This bit enables the device to use the memory write and invalidate command. Since the PCI2040 does not support MWI but uses MW instead, this bit is hardwired to 0.
3	Special	R	Special cycle. This bit controls the device's response to special cycle commands. Since PCI2040 does not monitor any special commands, this bit is set to 0.
2	MAST_EN	R	Bus master control. This bit allows a PCI device to function as a bus master. This bit is always 0 indicating PCI2040 does not support PCI mastering.
1	MEM_EN	RW	Memory space enable. This bit enables the device to respond to memory accesses to any of the defined base address memory regions. If this bit is cleared, then the PCI2040 will not respond to memory-mapped accesses.
0	IO_EN	RW	I/O space control. This bit enables the device to respond to I/O accesses within its defined base address register I/O regions.

4.4 PCI Status Register

The PCI status register provides the host information to the host system. A bit in this register is reset when 1 is written to it. A 0 written to a bit has no effect.

Bit	15	14	13	12	11	10	9	8	7	6	5	4	3	2	1	0
Name	PCI status															
Type	RC	RC	R	R	RC	R	R	R	R	R	R	R	R	R	R	R
Default	0	0	0	0	0	0	1	0	0	0	0	1	0	0	0	0

Register: **PCI status**
 Type: Read-only, Read/Write to Clear
 Offset: 06h
 Default: 0210h

Table 4–4. PCI Status Register

BIT	FIELD NAME	TYPE	DESCRIPTION
15	PAR_ERR	RC	Detected parity error. This bit is set by the PCI2040 to indicate that it detected a parity error.
14	SYS_ERR	RC	Signaled system error. This bit is set by the PCI2040 to indicate that it signaled a system error on the SERR pin. This bit can be reset by writing a 1.
13	MABORT	R	Receive master abort. This bit is set to indicate a transaction has been terminated due to a master abort.
12	TABT_REC	R	Receive target abort. This bit is set when a transaction is terminated by a target abort.
11	TABT_SIG	RC	Signaled target abort. This bit is set by the PCI slave unit in the PCI2040 to indicate that it has initiated a target abort.
10–9	PCI_SPEED	R	DEVSEL timing. Bits 10 and 9 encode the timing of DEVSEL and are hardwired to 01b indicating that the PCI2040 asserts PCI_SPEED at a medium speed on nonconfiguration cycle accesses.
8	DATAPAR	R	Data parity error detected. This bit is implemented by the bus mastering devices to indicate that a parity error has been detected.
7	FBB_CAP	R	Fast back-to-back capable. This bit indicates that the device is capable of performing fast back-to-back transactions. Since the PCI2040 does not support fast back-to-back transactions, this bit is hardwired to 0.
6	UDF	R	User definable feature support. Bit 6 is hardwired to 0 indicating that the PCI2040 does not support UDF.
5	66MHZ	R	66-MHz capable. Bit 5 is hardwired to 0 indicating that the PCI2040 does not support 66 MHz operations.
4	CAPLIST	R	Capabilities list. Bit 4 returns 1 when read indicating that capabilities in addition to standard capabilities are implemented.
3–0	RSVD	R	Reserved. Bits 3–0 return 0s when read.

4.5 Revision ID

This register indicates the silicon revision of the PCI2040.

Bit	7	6	5	4	3	2	1	0
Name	Revision ID							
Type	R	R	R	R	R	R	R	R
Default	0	0	0	0	0	0	0	0

Register: **Revision ID**
 Type: Read-only
 Offset: 08h
 Default: 00h

4.6 Class Code

The class code register categorizes the function as a bridge device (06h), and another bridge device (80h) with a standard programming interface (00h). Subclass and base class are loaded via serial ROM.

Bit	23	22	21	20	19	18	17	16	15	14	13	12	11	10	9	8	7	6	5	4	3	2	1	0	
Name	Class code																								
	Base class								Subclass								Programming interface								
Type	R	R	R	R	R	R	R	R	R	R	R	R	R	R	R	R	R	R	R	R	R	R	R	R	R
Default	0	0	0	0	0	1	1	0	1	0	0	0	0	0	0	0	0	0	0	0	0	0	0	0	0

Register: **Class code**
 Type: Read-only
 Offset: 09h
 Default: 068000h

4.7 Cache Line Size Register

The cache line size register is programmed by the host software to indicate the cache line size.

Bit	7	6	5	4	3	2	1	0
Name	Cache line size							
Type	RW	RW	RW	RW	RW	RW	RW	RW
Default	0	0	0	0	0	0	0	0

Register: **Cache line size**
 Type: Read/Write
 Offset: 0Ch
 Default: 00h

4.8 Latency Timer Register

The latency timer register returns 0s when read since the PCI2040 is a target-only device.

Bit	7	6	5	4	3	2	1	0
Name	Latency timer							
Type	R	R	R	R	R	R	R	R
Default	0	0	0	0	0	0	0	0

Register: **Latency timer**
 Type: Read-only
 Offset: 0Dh
 Default: 00h

4.9 Header Type Register

The header type register returns 00h when read, indicating that the PCI2040 configuration space adheres to the standard PCI header and it is a single function device.

Bit	7	6	5	4	3	2	1	0
Name	Header type							
Type	R	R	R	R	R	R	R	R
Default	0	0	0	0	0	0	0	0

Register: **Header type**
 Type: Read-only
 Offset: 0Eh
 Default: 00h

4.10 BIST Register

The PCI2040 does not support built-in-self-test (BIST); therefore, this register returns 00h when read.

Bit	7	6	5	4	3	2	1	0
Name	BIST							
Type	R	R	R	R	R	R	R	R
Default	0	0	0	0	0	0	0	0

Register: **BIST**
 Type: Read-only
 Offset: 0Fh
 Default: 00h

4.11 HPI CSR Memory Base Address Register

The HPI CSR memory base address register provides a method of allowing the host to map the PCI2040's HPI CSR registers into host memory space.

Bit	31	30	29	28	27	26	25	24	23	22	21	20	19	18	17	16
Name	HPI CSR memory base address															
Type	RW	RW	RW	RW	RW	RW	RW	RW	RW	RW	RW	RW	RW	RW	RW	RW
Default	0	0	0	0	0	0	0	0	0	0	0	0	0	0	0	0
Bit	15	14	13	12	11	10	9	8	7	6	5	4	3	2	1	0
Name	HPI CSR memory base address															
Type	RW	RW	RW	RW	R	R	R	R	R	R	R	R	R	R	R	R
Default	0	0	0	0	0	0	0	0	0	0	0	0	0	0	0	0

Register: **HPI CSR memory base address**
 Type: Read-only, Read/Write
 Offset: 10h
 Default: 0000 0000h

Table 4–5. HPI CSR Memory Base Address Register

BIT	FIELD NAME	TYPE	DESCRIPTION
31–12	AVAIL_ADD	RW	Available address bits. These bits can be written by the host in order to allow initialization of the base address at startup. The PCI memory address space is on the 4-Kbyte boundary.
11–4	UNAVAIL_ADD	R	Unavailable address bit. Bits 11–4 return 00h when read.
3	PREFETCHABLE	R	Prefetchable. This bit is hardwired to 0 in the PCI2040.
2–1	TYPE	R	Type. Bits 2 and 1 indicate the size of the base address and how it can be mapped into the host memory. These bits are hardwired to 00 in the PCI2040 to indicate that a 32-bit base address register is used which can be located anywhere in memory.
0	MEM_IND	R	Memory space indicator. This bit indicates whether the base address maps into the host's memory or I/O space. This bit is hardwired to 0 in the PCI2040 to indicate that this base address is valid only for memory accesses.

4.12 Control Space Base Address Register

The control space base address register allows the host to map the PCI2040's 32K bytes of control space into host memory.

Bit	31	30	29	28	27	26	25	24	23	22	21	20	19	18	17	16
Name	Control space base address															
Type	RW	RW	RW	RW	RW	RW	RW	RW	RW	RW	RW	RW	RW	RW	RW	RW
Default	0	0	0	0	0	0	0	0	0	0	0	0	0	0	0	0
Bit	15	14	13	12	11	10	9	8	7	6	5	4	3	2	1	0
Name	Control space base address															
Type	RW	R	R	R	R	R	R	R	R	R	R	R	R	R	R	R
Default	0	0	0	0	0	0	0	0	0	0	0	0	0	0	0	0

Register: **Control space base address**
 Type: Read-only, Read/Write
 Offset: 14h
 Default: 0000 0000h

Table 4–6. Control Space Base Address Register

BIT	FIELD NAME	TYPE	DESCRIPTION
31–15	AVAIL_ADD	RW	Available address bits. Bits 31–15 allow the host to map the PCI2040's 32K bytes of control space into memory. See Sections 3.5.2, <i>DSP Chip Selects</i> , and 3.5.3, <i>HPI Register Access Control</i> , for details on addressing the control space.
14–4	RSVD	R	Reserved. Bits 14–4 return 0s when read.
3	PREFETCHABLE	R	Prefetchable. This bit is hardwired to 0 in the PCI2040. The control space is not prefetchable.
2–1	TYPE	R	Type. Bits 2 and 1 indicate the size of the base address and how it can be mapped into the host memory. These bits are hardwired to 00 in the PCI2040 to indicate that a 32-bit base address register is used which can be located anywhere in memory.
0	MEM_IND	R	Memory space indicator. This bit indicates whether the base address maps into the host's memory or I/O space. This bit is hardwired to 0 in the PCI2040 to indicate that the control space is memory-mapped.

4.13 GP Bus Base Address Register

The GP bus base address register is used by the PCI2040 to communicate with a device on the GP bus. This 32-bit register allows software to assign a memory window for the GP bus anywhere in the 4-Gbyte address space. This window has a 256-byte granularity which means the lower 8 bits of this register default to 0 and are read-only. This register is controlled via bit 5 (GP_EN) in the miscellaneous control register (see Section 4.26) and if it is set to 0, then this register will be read-only and always return 0000 0000h when read.

Bit	31	30	29	28	27	26	25	24	23	22	21	20	19	18	17	16
Name	GP bus base address															
Type	RW	RW	RW	RW	RW	RW	RW	RW	RW	RW	RW	RW	RW	RW	RW	RW
Default	0	0	0	0	0	0	0	0	0	0	0	0	0	0	0	0
Bit	15	14	13	12	11	10	9	8	7	6	5	4	3	2	1	0
Name	GP bus base address															
Type	RW	RW	RW	RW	RW	RW	RW	RW	R	R	R	R	R	R	R	R
Default	0	0	0	0	0	0	0	0	0	0	0	0	0	0	0	0

Register: **GP bus base address**
 Type: Read-only, Read/Write
 Offset: 18h
 Default: 0000 0000h

Table 4–7. General-Purpose Bus Base Address Register

BIT	FIELD NAME	TYPE	DESCRIPTION
31–8	AVAIL_ADD	RW	Available address bits. Bits 31–8 allow the host to map the PCI2040's 128 bytes of control space into memory.
7–4	RSVD	R	Reserved. Bits 7–4 return 0s when read.
3	PREFETCHABLE	R	Prefetchable. This bit is hardwired to 0 in the PCI2040. The control space is not prefetchable.
2–1	TYPE	R	Type. Bits 2–1 indicate the size of the base address and how it can be mapped into the host memory. These bits are hardwired to 00 in the PCI2040 to indicate that a 32-bit base address register is used which can be located anywhere in memory.
0	MEM_IND	R	Memory space indicator. This bit indicates whether the base address maps into the host's memory or I/O space. This bit is hardwired to 0 in the PCI2040 to indicate that this register is memory-mapped.

4.14 Subsystem Vendor ID Register

The subsystem vendor ID register is used for system identification purposes and may be required for certain operating systems. This register is read-only or read/write depending on the value of bit 0 (SUBSYSRW) in the miscellaneous control register (see Section 4.26). When bit 0 (SUBSYSRW) is 0, this register is read/write and when bit 0 is 1, this register is read-only. This register may be loaded from the serial ROM.

Bit	15	14	13	12	11	10	9	8	7	6	5	4	3	2	1	0
Name	Subsystem vendor ID															
Type	R	R	R	R	R	R	R	R	R	R	R	R	R	R	R	R
Default	0	0	0	0	0	0	0	0	0	0	0	0	0	0	0	0

Register: **Subsystem vendor ID**
 Type: Read-only
 Offset: 2Ch
 Default: 0000h

4.15 Subsystem ID Register

The subsystem ID register is used for system identification purposes and may be required for certain operating systems. This register is read-only or read/write depending on the value of bit 0 (SUBSYSRW) in the miscellaneous control register (see Section 4.26). When bit 0 (SUBSYSRW) is 0, this register is read/write and when bit 0 is 1, this register is read-only. This register may be loaded from the serial ROM.

Bit	15	14	13	12	11	10	9	8	7	6	5	4	3	2	1	0
Name	Subsystem ID															
Type	R	R	R	R	R	R	R	R	R	R	R	R	R	R	R	R
Default	0	0	0	0	0	0	0	0	0	0	0	0	0	0	0	0

Register: **Subsystem ID**
 Type: Read-only
 Offset: 2Eh
 Default: 0000h

4.16 Capability Pointer Register

The capability pointer register provides a pointer into the PCI configuration header where the PCI power management block resides.

Bit	7	6	5	4	3	2	1	0
Name	Capability pointer							
Type	R	R	R	R	R	R	R	R
Default	0	1	0	1	0	0	0	0

Register: **Capability pointer**
 Type: Read-only
 Offset: 34h
 Default: 50h

4.17 Interrupt Line Register

The interrupt line register is written by the host and indicates to which input of the system interrupt controller the PCI2040's interrupt pin is connected.

Bit	7	6	5	4	3	2	1	0
Name	Interrupt line							
Type	RW	RW	RW	RW	RW	RW	RW	RW
Default	1	1	1	1	1	1	1	1

Register: **Interrupt line**
 Type: Read/Write
 Offset: 3Ch
 Default: FFh

4.18 Interrupt Pin Register

The interrupt pin register tells which interrupt the device uses. This register is hardwired to 01h in the PCI2040 to indicate that \overline{INTA} will be used.

Bit	7	6	5	4	3	2	1	0
Name	Interrupt pin							
Type	R	R	R	R	R	R	R	R
Default	0	0	0	0	0	0	0	1

Register: **Interrupt pin**
 Type: Read-only
 Offset: 3Dh
 Default: 01h

4.19 MIN_GNT Register

This register specifies the length of the burst period for the device needs in 0.25 μ sec units. The default value for this register is 00h as the PCI2040 is a target-only device.

Bit	7	6	5	4	3	2	1	0
Name	MIN_GNT							
Type	R	R	R	R	R	R	R	R
Default	0	0	0	0	0	0	0	0

Register: **MIN_GNT**
 Type: Read-only
 Offset: 3Eh
 Default: 00h

4.20 MAX_LAT Register

This register specifies how often the device needs to gain access to the PCI bus in 0.25 μ sec units. The default value for this register is 00h as the PCI2040 is a target-only device.

Bit	7	6	5	4	3	2	1	0
Name	MAX_LAT							
Type	R	R	R	R	R	R	R	R
Default	0	0	0	0	0	0	0	0

Register: **MAX_LAT**
 Type: Read-only
 Offset: 3Fh
 Default: 00h

4.21 GPIO Select Register

The GPIO select register is used to program the GPIOx terminal functions.

Bit	7	6	5	4	3	2	1	0
Name	GPIO select							
Type	R	R	RU	RU	RW	RW	RW	RW
Default	0	0	0	0	0	0	0	0

Register: **GPIO select**
 Type: Read/Update/Write
 Offset: 44h
 Default: 00h

Table 4–8. GPIO Select Register

BIT	FIELD NAME	TYPE	DESCRIPTION
7–6	RSVD	R	Reserved. Bits 7 and 6 return 0s when read.
5	GPIO5Pin	RU	GPIO5 pin. The value of this pin determines the function of GPIO5. 0 = Normal GPIO data (default) 1 = GP_RD. Read strobe (RD) for the GP bus. The PCI2040 will set this bit when bit 5 (GP_EN) in the miscellaneous control register is set (see Section 4.26). Clearing bit 5 (GP_EN) will automatically clear this bit.
4	GPIO4Pin	RU	GPIO4 pin. The value of this pin determines the function of GPIO4. 0 = Normal GPIO data (default) 1 = GPWR. Write strobe (WR) for the GP bus. The PCI2040 will set this bit when bit 5 (GP_EN) in the miscellaneous control register is set (see Section 4.26). Clearing bit 5 (GP_EN) will automatically clear this bit.
3	GPIO3Pin	RW	GPIO3 pin. The value of this pin determines the function of GPIO3. When programmed as an interrupt event input, the event is selected in the GPIO interrupt event type register (see Section 4.25). When programmed as a normal GPIO, the IntGPIO3 interrupt event will never occur. 0 = Normal GPIO data (default) 1 = GPIO3 is an interrupt event input
2	GPIO2Pin	RW	GPIO2 pin. The value of this pin determines the function of GPIO2. When programmed as an interrupt event input, the event is selected in the GPIO interrupt event type register (see Section 4.25). When programmed as a normal GPIO, the IntGPIO2 interrupt event will never occur. 0 = Normal GPIO data (default) 1 = GPIO2 is an interrupt event input
1	GPIO1Pin	R	GPIO1 pin. The value of this pin determines the function of GPIO1. 0 = Normal GPIO data (default) 1 = Reserved.
0	GPIO0Pin	R	GPIO0 pin. The value of this pin determines the function of GPIO0. 0 = Normal GPIO data (default) 1 = Reserved.

4.22 GPIO Input Data Register

The GPIO input data register reflects the state of the GPIO pins, and defaults to an unknown value.

Bit	7	6	5	4	3	2	1	0
Name	GPIO input data							
Type	R	R	R	R	R	R	R	R
Default	0	0	X	X	X	X	X	X

Register: **GPIO input data**
 Type: Read-only
 Offset: 45h
 Default: XXh

Table 4–9. GPIO Input Data Register

BIT	FIELD NAME	TYPE	DESCRIPTION
7–6	RSVD	R	Reserved. Bits 7 and 6 return 0s when read.
5–0	GPIO[5:0] Pin State	R	GPIO5–GPIO0 pin state. Returns the logical value of the data input to the GPIO5–GPIO0 terminals.

4.23 GPIO Direction Control Register

The GPIO direction control register controls the direction of GPIO pins.

Bit	7	6	5	4	3	2	1	0
Name	GPIO direction control							
Type	R	R	RW	RW	RW	RW	RW	RW
Default	0	0	0	0	0	0	0	0

Register: **GPIO direction control**
 Type: Read-only, Read/Write
 Offset: 46h
 Default: 00h

Table 4–10. GPIO Direction Control Register

BIT	FIELD NAME	TYPE	DESCRIPTION
7–6	RSVD	R	Reserved. Bits 7 and 6 return 0s when read.
5–0	GPIO[5:0] Direction Control	RW	GPIO5–GPIO0 direction control. When the GPIO _n direction control bit is set, then the GPIO _n signal is an output. When the GPIO _n direction control bit is 0, the GPIO _n signal is an input.

4.24 GPIO Output Data Register

The GPIO output data register contains the output data for any selected output pin.

Bit	7	6	5	4	3	2	1	0
Name	GPIO output data							
Type	R	R	RW	RW	RW	RW	RW	RW
Default	0	0	0	0	0	0	0	0

Register: **GPIO output data**
 Type: Read-only, Read/Write
 Offset: 47h
 Default: 00h

Table 4–11. GPIO Output Data Register

BIT	FIELD NAME	TYPE	DESCRIPTION
7–6	RSVD	R	Reserved. Bits 7 and 6 return 0s when read.
5–0	GPIO[5:0] Output data	RW	GPIO5–GPIO0 output data. 0 = Data out value, if selected, is 0 (default) 1 = Data out value, if selected, is 1.

4.25 GPIO Interrupt Event Type Register

The GPIO interrupt event type register gives the status of GPIO routed through \overline{INTA} .

Bit	7	6	5	4	3	2	1	0
Name	GPIO interrupt event type							
Type	R	R	R	R	RW	RW	R	R
Default	0	0	0	0	0	0	0	0

Register: **GPIO interrupt event type**
 Type: Read-only, Read/Write
 Offset: 48h
 Default: 00h

Table 4–12. GPIO Interrupt Event Type Register

BIT	FIELD NAME	TYPE	DESCRIPTION
7–4	RSVD	R	Reserved. Bits 7–4 return 0s when read.
3	GPIO3INTYPE	RW	GPIO3 interrupt type. 0 = Bit 28 (IntGPIO3) in the interrupt event register (see Section 5.1) is set when GPIO3 input is low (default) 1 = Bit 28 (IntGPIO3) in the interrupt event register (see Section 5.1) is set when GPIO3 input changes state
2	GPIO2INTYPE	RW	GPIO2 interrupt type. 0 = Bit 27 (IntGPIO2) in the interrupt event register (see Section 5.1) is set when GPIO2 input is low (default) 1 = Bit 27 (IntGPIO2) in the interrupt event register (see Section 5.1) is set when GPIO2 input changes state
1–0	RSVD	R	Reserved. Bits 1–0 return 0s when read.

4.26 Miscellaneous Control Register

The miscellaneous control register controls various miscellaneous functions.

Bit	15	14	13	12	11	10	9	8	7	6	5	4	3	2	1	0
Name	Miscellaneous control															
Type	RU	RCU	R	R	R	R	R	R	R	R	RW	RW	RW	RW	RW	RW
Default	0	0	0	0	0	0	0	0	0	0	0	0	1	1	1	1

Register: **Miscellaneous control**
 Type: Read/Clear/Update/Write
 Offset: 4Ch
 Default: 000Fh

Table 4–13. Miscellaneous Control Register

BIT	FIELD NAME	TYPE	DESCRIPTION
15	SEEDS	RU	Serial EEPROM detect status. When this bit is set, it indicates that serial EEPROM block has detected an EEPROM.
14	SEEBES	RCU	Serial EEPROM error status. When set, an error has occurred on the serial ROM interface. Writing a 1 to this bit clears the error status.
13	SEEBES	R	Serial EEPROM busy status. When set, the serial ROM interface is busy.
12–9	RSVD	R	Reserved. Bits 12–9 return 0s when read.
8	HSSWITCH_STS	R	Hot swap switch status. Returns logical value of HSSWITCH input. 0 = Handle closed 1 = Handle open
7–6	RSVD	R	Reserved. Bits 7–6 return 0s when read.
5	GP_EN	R	GP bus enable. 0 = GP bus disabled. (default) 1 = GP bus enabled.
4	PM11_EN	R	PCI PM Specification 1.1 enable. 0 = Use PCI PM 1.0 register implementation (Default) 1 = Use PCI PM 1.1 register implementation
3	HSEN	R	Hot swap enable. 0 = Hot swap disabled 1 = Hot swap enabled (default)
2	D3COLD_LOCK	R	Lock bit for $\overline{\text{PME}}$ support from D3 _{cold} . 0 = Bit 15 (D3cold_PMEsupport) in the power management capabilities register is read/write (see Section 4.30) 1 = Bit 15 (D3cold_PMEsupport) in the power management capabilities register is read-only (default) (see Section 4.30)
1	PWDIS	R	Posted write disable bit. 0 = Posted writes are disabled 1 = Posted writes are enabled (default)
0	SUBSYSRW	R	Subsystem read write enable. 0 = Subsystem ID and subsystem vendor ID registers are read/write 1 = Subsystem ID and subsystem vendor ID registers are read-only (default)

4.27 Diagnostic Register

The diagnostic register is provided for test purposes and should not be accessed during normal operation.

Bit	7	6	5	4	3	2	1	0
Name	Diagnostic							
Type	RW	R	R	RW	RW	R	RW	RW
Default	0	0	0	0	0	0	0	0

Register: **Diagnostic**
 Type: Read/Write
 Offset: 4Fh
 Default: 00h

Table 4–14. Diagnostic Register

BIT	FIELD NAME	TYPE	DESCRIPTION
7	TRUE_VAL	RW	True value. When set, all 1s are returned in the PCI vendor and device ID registers.
6–5	RSVD	R	Reserved. Bits 6–5 return 0s when read.
4	DIAG4	RW	Diagnostic RETRY_DIS. Delayed transaction disable. When bit 4 is set, delayed transactions are disabled. When bit 4 is 0 (default), they are enabled.
3	DIAG3	RW	Diagnostic RETRY_EXT. When set, the PCI2040 extends the target latency from 16 to 64 PCI clocks and is not <i>PCI Local Bus Specification, Revision 2.2</i> compliant.
2	RSVD	R	Reserved. Bit 2 returns 0 when read.
1	ErrorTimer	RW	Error timer. Bit 1 is used to enable/disable the error timer. By default, the timer is enabled but can be disabled by writing a 1 to this bit.
0	TI_TEST	RW	TI_TEST_BIT. This is internal TI test bit used by the design. 0 = Disable state vectors to GPIOs (default) 1 = Enable state vectors to GPIOs

4.28 PM Capability ID Register

The PM capability ID register identifies the linked list item as the register for PCI power management. This register returns 01h when read, which is the unique ID located by the PCI SIG for the PCI location of the capabilities pointer and the value.

Bit	7	6	5	4	3	2	1	0
Name	PM capability ID							
Type	R	R	R	R	R	R	R	R
Default	0	0	0	0	0	0	0	1

Register: **PM capability ID**
 Type: Read-only
 Offset: 50h
 Default: 01h

4.29 PM Next-Item Pointer Register

The PM next-item pointer register provides a pointer into the PCI configuration header where the CPCI hot swap control and status register (HS_CSR) resides. The PCI header at 5Ch provides the hot swap register. If bit 3 (HSEN) in the miscellaneous control register (see Section 4.26) is 0, then the PM next-item pointer register returns 00h when read indicating the end of the extended capability list.

Bit	7	6	5	4	3	2	1	0
Name	PM next-item pointer							
Type	R	R	R	R	R	R	R	R
Default	0	1	0	1	1	1	0	0

Register: **PM next-item pointer**
 Type: Read-only
 Offset: 51h
 Default: 5Ch

4.30 Power Management Capabilities Register

The power management capabilities (PMC) register contains information on the capabilities of the PCI2040 related to power management. The PCI2040 supports all D0–D3 power states.

Bit	15	14	13	12	11	10	9	8	7	6	5	4	3	2	1	0
Name	Power management capabilities															
Type	R	R	R	R	R	R	R	R	R	R	R	R	R	R	R	R
Default	1	1	1	1	1	1	1	0	0	0	0	1	0	0	0	1

Register: **Power management capabilities**
 Type: Read-only
 Offset: 52h
 Default: FE11h

Table 4–15. Power Management Capabilities Register

BIT	FIELD NAME	TYPE	DESCRIPTION
15	D3cold_PMEsupport	R(W)	D3 _{cold} $\overline{\text{PME}}$ support. This bit defaults to read-only and becomes read/write when bit 2 (D3COLD_LOCK) in the miscellaneous control register is set (see Section 4.26). This bit defaults to 1 indicating the $\overline{\text{PME}}$ signal can be asserted from the D3 _{cold} state. This bit is read/write because wake-up support from D3 _{cold} is contingent on the system providing an auxiliary power source to the Vcc terminals. If auxiliary power is not provided to Vcc terminals for D3 _{cold} wake-up, then this bit should be cleared. This bit is not reset by the assertion of PCI_RST, but is reset by $\overline{\text{GRST}}$.
14–11	PME Support	R	This field has a value of 4'b1111 indicating that the PCI2040 can signal $\overline{\text{PME}}$ from the D3 _{hot} , D2, D1 and D0 states.
10	D2_Support	R	This bit returns a 1 when read indicating that the PCI2040 supports D2.
9	D1_Support	R	This bit returns a 1 when read indicating that the PCI2040 supports D1.
8–6	RSVD	R	Reserved. Bits 8–6 return 0s when read.
5	DSI	R	Device specific initialization. This bit returns 0 when read indicating no special initialization is required before a standard driver can use the PCI2040.
4	AUX_PWR	R	Auxiliary power source. Bit 4 returns 1 when read indicating $\overline{\text{PME}}$ support in D3 _{cold} requires an auxiliary power source.
3	PMECLK	R	This bit returns 0 when read indicating that no PCI clock is required for the function to generate $\overline{\text{PME}}$.
2–0	Version	R	These three bits return 001b when read indicating compliance to <i>PCI Bus Power Management Interface Specification</i> .

4.31 Power Management Control/Status Register

The power management control/status register determines and changes the current power state of the PCI2040. The contents of this register are not affected by the internally generated reset caused by the transition from the D3_{hot} to D0 state. All PCI registers will be reset as a result of a D3_{hot}-to-D0 state transition. TI specific registers, PCI power management registers, and the legacy base address register are not reset.

Bit	15	14	13	12	11	10	9	8	7	6	5	4	3	2	1	0
Name	Power management control/status															
Type	RCU	R	R	R	R	R	R	RW	R	R	R	R	R	R	RW	RW
Default	0	0	0	0	0	0	0	0	0	0	0	0	0	0	0	0

Register: **Power management control/status**
 Type: Read/Clear/Update/Write
 Offset: 54h
 Default: 0000h

Table 4–16. Power Management Control/Status Register

BIT	FIELD NAME	TYPE	DESCRIPTION
15	PME_STS	RCU	PME status. This bit is set when the $\overline{\text{PME}}$ signal is asserted, independent of the state of bit 8 (PME_EN). This bit is cleared by a write back of 1, and this also clears the $\overline{\text{PME}}$ signal if $\overline{\text{PME}}$ was asserted. Writing a 0 to this bit has no effect. This bit will NOT be cleared by the assertion of $\overline{\text{PCI_RST}}$. It will only be cleared by the assertion of $\overline{\text{GRST}}$.
14–13	DATASCALE	R	Data scale. This two-bit field returns 0s when read.
12–9	DATASEL	R	Data select. This four-bit field returns 0s when read.
8	PME_EN	RW	$\overline{\text{PME}}$ enable. This bit enables the function to assert $\overline{\text{PME}}$. If bit 8 is cleared, then assertion of $\overline{\text{PME}}$ is disabled. Bit 8 is NOT cleared by the assertion of $\overline{\text{PCI_RST}}$. It is only cleared by the assertion of $\overline{\text{GRST}}$.
7–2	RSVD	R	Reserved. Bits 7–2 return 0s when read.
1–0	PWRSTATE	RW	Power state. This two-bit field is used both to determine the current power state of a function, and to set the function into a new power state. This field is encoded as: 00 = D0 01 = D1 10 = D2 11 = D3 _{hot}

4.32 HPI CSR I/O Base Address Register

The PCI2040 supports the index/data scheme of accessing the HPI CSR registers. An address written to this register is the address for the index register and the address + 1 is the data address. The base address can be mapped anywhere in 32-bit I/O space on a word boundary except at address 0x0000; hence, bit 0 is read-only, returning 0 when read.

The HPI CSR I/O base address is only meaningful when a nonzero value is written into this register.

Bit	31	30	29	28	27	26	25	24	23	22	21	20	19	18	17	16
Name	HPI CSR I/O base address															
Type	RW	RW	RW	RW	RW	RW	RW	RW	RW	RW	RW	RW	RW	RW	RW	RW
Default	0	0	0	0	0	0	0	0	0	0	0	0	0	0	0	0
Bit	15	14	13	12	11	10	9	8	7	6	5	4	3	2	1	0
Name	HPI CSR I/O base address															
Type	RW	RW	RW	RW	RW	RW	RW	RW	RW	RW	RW	RW	RW	RW	RW	R
Default	0	0	0	0	0	0	0	0	0	0	0	0	0	0	0	0

Register: **HPI CSR I/O base address**
 Type: Read-only, Read/Write
 Offset: 58h
 Default: 0000 0000h

Table 4–17. HPI CSR I/O Base Address Register

BIT	FIELD NAME	TYPE	DESCRIPTION
31–1	HPICSR_IO_BAR	RW	Available address bits. These bits can be written by the host in order to allow initialization of the base address at startup.
0	RSVD	R	Reserved. Bit 0 returns 0 when read for word alignment.

4.33 HS Capability ID Register

The HS capability ID register identifies the linked list item as the register for CompactPCI hot swap. This register returns 06h when read which is the unique ID assigned by the PCI SIG for the PCI location of the capabilities pointer and the value.

Bit	7	6	5	4	3	2	1	0
Name	HS capability ID							
Type	R	R	R	R	R	R	R	R
Default	0	0	0	0	0	1	1	0

Register: **HS capability ID**
 Type: Read-only
 Offset: 5Ch
 Default: 06h

4.34 HS Next-Item Pointer Register

The HS next-item pointer register is used to indicate the next item in the linked list of the PCI extended capabilities. This register returns 00h indicating no additional capabilities are supported.

Bit	7	6	5	4	3	2	1	0
Name	HS next-item pointer							
Type	R	R	R	R	R	R	R	R
Default	0	0	0	0	0	0	0	0

Register: **HS next-item pointer**
 Type: Read-only
 Offset: 5Dh
 Default: 00h

4.35 CPCI Hot Swap Control and Status Register

The CPCI hot swap control and status register (HS_CSR) provides the control and status information about the compact PCI hot swap resources.

Bit	7	6	5	4	3	2	1	0
Name	CPCI hot swap control and status							
Type	RCU	RCU	R	R	RW	R	RW	R
Default	0	0	0	0	0	0	0	0

Register: **CPCI hot swap control and status**
 Type: Read/Clear/Update/Write
 Offset: 5Eh
 Default: 00h

Table 4–18. CPCI Hot Swap Control and Status Register

BIT	FIELD NAME	TYPE	DESCRIPTION
7	INS	RCU	ENUM insertion status. When set, the HSENUM output is driven by the PCI2040. This bit defaults to 0, and will be set after a PCI_RST occurs, the preload of serial ROM is complete (miscellaneous control register, bit 13 [SEEBS] is 0), the ejector handle is closed (miscellaneous control register, bit 8 [HSSWITCH_STS] is 0), and bit 6 (EXT) is 0. Thus, this bit is set following an insertion when the board implementing the PCI2040 is ready for configuration. This bit cannot be set under software control.
6	EXT	RCU	ENUM extraction status. When set, the HSENUM output is driven by the PCI2040. This bit defaults to 0, and is set when the ejector handle is opened (miscellaneous control register, bit 8 [HSSWITCH_STS] is 1) and bit 7 (INS) is 0. Thus, this bit is set when the board implementing the PCI2040 is about to be removed. This bit cannot be set under software control.
5–4	RSVD	R	Reserved. Bits 5 and 4 return 0s when read.
3	LOO	RW	LED on/off. This bit defaults to 0, and controls the external LED indicator (HSLED) under normal conditions. However, for a duration following a PCI_RST, the HSLED output is driven high by the PCI2040 control and this bit will be ignored. When this bit is interpreted, a 1 will cause HSLED high and a 0 will cause HSLED low. Following PCI_RST, the HSLED output is driven high by the PCI2040 until both the pre-load of serial ROM (miscellaneous control register, bit 13 [SEEBS] is 0), and the ejector handle is closed (miscellaneous control register, bit 8 [HSSWITCH_STS] is 0). When these conditions are met, the HSLED is under software control via bit 3 (LOO).
2	RSVD	R	Reserved. Bit 2 returns 0 when read.
1	EIM	RW	ENUM interrupt mask. This bit allows the HSENUM output to be masked by software. Bits 7 (INS) and 6 (EXT) are set independently from bit 1. 0 = Enable HSENUM output 1 = Mask HSENUM output
0	RSVD	R	Reserved. Bit 0 returns 0 when read.

5 HPI Control and Status Registers

This section covers the PCI2040 HPI control and status register (HPI CSR) space. The PCI2040 allows software to access the HPI configuration through either memory or I/O address space. The memory base address is programmable via the HPI CSR base address register (PCI offset 10h). The I/O base address is programmable via the HPI CSR I/O base address register (PCI offset 58h).

Table 5–1. HPI Configuration Register Map

REGISTER NAME		OFFSET
Interrupt event set		00h
Interrupt event clear		04h
Interrupt mask set		08h
Interrupt mask clear		0Ch
Reserved	HPI error report	10h
HPI DSP implementation	HPI reset	14h
Reserved	HPI data width	18h

5.1 Interrupt Event Register

The interrupt event register reflects the state of the various PCI2040 interrupt sources. The interrupt bits are set by an asserting edge of the corresponding interrupt signal or by writing a 1 in the corresponding bit in the set register. The only mechanism to clear the bits in this register is to write a 1 to the corresponding bit in the clear register. Note that the interrupt event register itself is returned on reads from the interrupt event set register (offset 00h), but the bit-wise AND of the interrupt event and interrupt mask registers is returned on reads from the interrupt event clear register (offset 04h).

Bit	31	30	29	28	27	26	25	24	23	22	21	20	19	18	17	16	
Name	Interrupt event																
Type	R	RU	RSCU	RSCU	RSCU	RSCU	R	R	R	R	R	R	R	R	R	R	
Default	0	0	0	0	0	0	0	0	0	0	0	0	0	0	0	0	
Bit	15	14	13	12	11	10	9	8	7	6	5	4	3	2	1	0	
Name	Interrupt event																
Type	R	R	R	R	R	R	R	R	R	R	R	R	R	RSCU	RSCU	RSCU	RSCU
Default	0	0	0	0	0	0	0	0	0	0	0	0	0	0	0	0	0

Register: **Interrupt event**
 Type: Read/Set/Clear/Update
 Offset: 00h Set Register
 04h Clear Register [Returns IntEvent & IntMask when read]
 Default: 0000 0000h

Table 5–2. Interrupt Event Register

BIT	FIELD NAME	TYPE	DESCRIPTION
31	RSVD	R	Reserved. Bit 31 returns 0 when read.
30	HPIError	RU	Bit 30 is set upon serious error conditions on the HPI interface, and allows software to gracefully terminate communication with an HPI device. This bit is the OR combination of the HPI errors in the HPI error report register (see Section 5.3).
29	GPError	RSCU	Bit 29 is set upon serious error conditions on the GP interface, and allows software to gracefully terminate communication with a GP device.
28	IntGPIO3	RSCU	Set when GPIO3Pin (see Section 4.21, bit 3) selects GPIO3 as an interrupt event input, and the event type selected by the GPIO interrupt event type register occurs (see Section 4.25).
27	IntGPIO2	RSCU	Set when GPIO2Pin (see Section 4.21, bit 2) selects GPIO2 as an interrupt event input, and the event type selected by the GPIO interrupt event type register occurs (see Section 4.25).
26	GPINT	RSCU	The PCI2040 sets this bit if an interrupt has been generated by a device connected to the GPINT interface. Software can set this bit for diagnostics.
25–4	RSVD	R	Reserved. Bits 25–4 return 0s when read.
3	IntDSP3	RSCU	The PCI2040 sets this bit if an interrupt has been generated by a device connected to the HPI[3] interface. Software can set this bit for diagnostics.
2	IntDSP2	RSCU	The PCI2040 sets this bit if an interrupt has been generated by a device connected to the HPI[2] interface. Software can set this bit for diagnostics.
1	IntDSP1	RSCU	The PCI2040 sets this bit if an interrupt has been generated by a device connected to the HPI[1] interface. Software can set this bit for diagnostics.
0	IntDSP0	RSCU	The PCI2040 sets this bit if an interrupt has been generated by a device connected to the HPI[0] interface. Software can set this bit for diagnostics.

5.2 Interrupt Mask Register

The interrupt mask register is used to enable the various PCI2040 interrupt sources. Reads from either the set register or the clear register always return interrupt mask. In all cases, except masterIntEnable (bit 31), the enables for each interrupt event align with the event register bits detailed in Table 5–2.

Bit	31	30	29	28	27	26	25	24	23	22	21	20	19	18	17	16
Name	Interrupt mask															
Type	RSC	RSC	RSC	RSC	RSC	RSC	R	R	R	R	R	R	R	R	R	R
Default	0	0	0	0	0	0	0	0	0	0	0	0	0	0	0	0
Bit	15	14	13	12	11	10	9	8	7	6	5	4	3	2	1	0
Name	Interrupt mask															
Type	R	R	R	R	R	R	R	R	R	R	R	R	RSC	RSC	RSC	RSC
Default	0	0	0	0	0	0	0	0	0	0	0	0	0	0	0	0

Register: **Interrupt mask**
 Type: Read/Set/Clear
 Offset: 08h Set Register
 0Ch Clear Register
 Default: 0000 0000h

Table 5–3. Interrupt Mask Register

BIT	FIELD NAME	TYPE	DESCRIPTION
31	masterIntEnable	RSC	When bit 31 is set, external interrupts are generated in accordance with this register. If bit 31 is 0, then no external interrupts are generated.
30	HPIError	RSC	When bit 30 is set and the interrupt event register, HPIError bit (see Table 5–2, bit 30) is also set, an interrupt is generated. When set, the HPI state machine will never cause target aborts on PCI and will return the PCI slave 0s on such errors. When set, errors on posted writes will not cause $\overline{\text{SERR}}$ signal assertions enabled by bit 8 (SERR_EN) in the PCI command register (see Section 4.3). When bit 30 is 0, target aborts may occur and SERR may be signaled as a result of a posted write error.
29	GPErrror	RSC	When bit 29 is set and the interrupt event register, GPErrror bit (see Table 5–2, bit 29) is also set, an interrupt is generated. When set, the GP state machine will never cause target aborts on PCI and will return the PCI slave 0s on such errors. When bits 29 and 30 are set, errors on posted writes will not cause SERR signal assertions enabled by bit 8 (SERR_EN) in the PCI command register (see Section 4.3). Both bits 29 and 30 need to be set to prevent target aborts.
28	IntGPIO3	RSC	When bit 28 is set and the corresponding interrupt event register bit (see Table 5–2, bit 28) is also set, an interrupt is generated. When bit 28 is 0, the interrupt is masked.
27	IntGPIO2	RSC	When bit 27 is set and the corresponding interrupt event register bit (see Table 5–2, bit 27) is also set, an interrupt is generated. When bit 27 is 0, the interrupt is masked.
26	GPINT	RSC	When bit 26 is set and the corresponding interrupt event register bit (see Table 5–2, bit 26) is also set, an interrupt is generated. When bit 26 is 0, the interrupt is masked.
25–4	RSVD	R	Reserved. Bits 25–4 return 0s when read.
3	IntDSP3	RSC	When bit 3 is set and the corresponding interrupt event register bit (see Table 5–2, bit 3) is also set, an interrupt is generated. When bit 3 is 0, the interrupt is masked.
2	IntDSP2	RSC	When bit 2 is set and the corresponding interrupt event register bit (see Table 5–2, bit 2) is also set, an interrupt is generated. When bit 2 is 0, the interrupt is masked.
1	IntDSP1	RSC	When bit 1 is set and the corresponding interrupt event register bit (see Table 5–2, bit 1) is also set, an interrupt is generated. When bit 1 is 0, the interrupt is masked.
0	IntDSP0	RSC	When bit 0 is set and the corresponding interrupt event register bit (see Table 5–2, bit 0) is also set, an interrupt is generated. When bit 0 is 0, the interrupt is masked.

5.3 HPI Error Report Register

The HPI error report register reflects the state of errors on the HPI interfaces. If any bits in this register are set, then the PCI2040 sets bit 30 (HPIError) in the interrupt event register (see Section 5.1). Software can set the bits in this register for diagnostics.

Bit	15	14	13	12	11	10	9	8	7	6	5	4	3	2	1	0
Name	HPI error report															
Type	R	R	R	R	R	R	R	R	R	R	R	R	RWU	RWU	RWU	RWU
Default	0	0	0	0	0	0	0	0	0	0	0	0	0	0	0	0

Register: **HPI error report**
 Type: Read/Write/Update
 Offset: 10h
 Default: 0000h

Table 5–4. HPI Error Report Register

BIT	FIELD NAME	TYPE	DESCRIPTION
15–4	RSVD	R	Reserved. Bits 15–4 return 0s when read.
3–0	HPIErr[3:0]	RWU	PCI2040 sets this bit if a serious error occurs on the HPI[x] interface. The error conditions that cause this bit to be set are as follows: <ol style="list-style-type: none"> 1. HRDY5xn (or HRDY6xn) driven by DSPn not sampled asserted within 256 PCI clocks following the assertion of HCSn by PCI2040 2. When the discard timeout expires for a read transaction from HPI[x] 3. A PCI byte enable combination other than 4'b1100, 4'b0011, or 4'b0000 was received for a transaction destined for a C54x DSP on HPI[x]

5.4 HPI Reset Register

The HPI reset register is used to cause resets to the DSP interfaces. The implemented bits in this register are in the PME context for PCI2040 and default to set. Thus, a GRST causes all DSP interfaces to be reset, and software is responsible for removing the HRSTn to the DSP interfaces.

Bit	15	14	13	12	11	10	9	8	7	6	5	4	3	2	1	0
Name	HPI reset															
Type	R	R	R	R	R	R	R	R	R	R	R	R	RW	RW	RW	RW
Default	0	0	0	0	0	0	0	0	0	0	0	0	1	1	1	1

Register: **HPI reset**
 Type: Read-only, Read/Write
 Offset: 14h
 Default: 000Fh

Table 5–5. HPI Reset Register

BIT	FIELD NAME	TYPE	DESCRIPTION
15–4	RSVD	R	Reserved. Bits 15–4 return 0s when read.
3	HPI3_RST	RW	HPI reset 3. When bit 3 is set, $\overline{\text{HRST3}}$ is asserted.
2	HPI2_RST	RW	HPI reset 2. When bit 2 is set, $\overline{\text{HRST2}}$ is asserted.
1	HPI1_RST	RW	HPI reset 1. When bit 1 is set, $\overline{\text{HRST1}}$ is asserted.
0	HPI0_RST	RW	HPI reset 0. When bit 0 is set, $\overline{\text{HRST0}}$ is asserted.

5.5 HPI DSP Implementation Register

The HPI DSP implementation register is used to indicate the presence of implemented DSPs on the HPI interface and is loaded from the serial ROM.

Bit	15	14	13	12	11	10	9	8	7	6	5	4	3	2	1	0
Name	HPI DSP implementation															
Type	R	R	R	R	R	R	R	R	R	R	R	R	RWU	RWU	RWU	RWU
Default	0	0	0	0	0	0	0	0	0	0	0	0	0	0	0	0

Register: **HPI DSP implementation**
 Type: Read/Write/Update
 Offset: 16h
 Default: 0000h

Table 5–6. HPI DSP Implementation Register

BIT	FIELD NAME	TYPE	DESCRIPTION
15–4	RSVD	R	Reserved. Bits 15–4 return 0s when read.
3	DSP_PRSENT3	RWU	DSP3 present. Bit 3 indicates if the DSP3 is present on the HPI interface.
2	DSP_PRSENT2	RWU	DSP2 present. Bit 2 indicates if the DSP2 is present on the HPI interface.
1	DSP_PRSENT1	RWU	DSP1 present. Bit 1 indicates if the DSP1 is present on the HPI interface.
0	DSP_PRSENT0	RWU	DSP0 present. Bit 0 indicates if the DSP0 is present on the HPI interface.

5.6 HPI Data Width Register

The HPI data width register is used to determine if the implemented DSPs are C54x or C6x, and is loaded from the serial ROM. Each bit in this register is meaningful only if the corresponding bit in the HPI DSP implementation register is set (see Section 5.5).

Bit	15	14	13	12	11	10	9	8	7	6	5	4	3	2	1	0
Name	HPI data width															
Type	R	R	R	R	R	R	R	R	R	R	R	R	RWU	RWU	RWU	RWU
Default	0	0	0	0	0	0	0	0	0	0	0	0	0	0	0	0

Register: **HPI data width**
 Type: Read/Write/Update
 Offset: 18h
 Default: 0000h

Table 5–7. HPI Data Width Register

BIT	FIELD NAME	TYPE	DESCRIPTION
15–4	RSVD	R	Reserved. Bits 15–4 return 0s when read.
3	DWIDTH3	RWU	When bit 3 is set, the HPI[3] data bus is 16 bits (C6x). When bit 3 is 0, it is 8 bits (C54x).
2	DWIDTH2	RWU	When bit 2 is set, the HPI[2] data bus is 16 bits (C6x). When bit 2 is 0, it is 8 bits (C54x).
1	DWIDTH1	RWU	When bit 1 is set, the HPI[1] data bus is 16 bits (C6x). When bit 1 is 0, it is 8 bits (C54x).
0	DWIDTH0	RWU	When bit 0 is set, the HPI[0] data bus is 16 bits (C6x). When bit 0 is 0, it is 8 bits (C54x).

6 DSP HPI Overview

This section gives an overview of the DSP host port interface (HPI). Refer to the C54x/C6x data sheets for complete HPI details.

6.1 C54X Host Port Interface

The HPI is an 8-bit parallel port used to interface a host device or host processor to a C54x DSP. Information is exchanged between the DSP and the host device through on-chip C54x memory that is accessible by both the host and the DSP.

The HPI is designed to interface to the host device as a peripheral, with the host device as the master of the interface, and so facilitating the ease of access by the host. The host device communicates with the HPI through dedicated address and data registers, to which the DSP does not have direct access, and the HPI control register using the external data and interface control signals. Both host devices and the HPI have access to the HPI control register.

In C54x, the HPI provides 16-bit data to the DSP while maintaining an external interface of 8-bit by automatically combining the successive bytes into 16-bit words. When the host performs a data transfer with the HPI registers, the HPI control logic automatically performs an access to DSP's memory to complete the transaction. The DSP can then access the data within its memory space.

6.1.1 Modes of Operation

In C54x, the HPI has two modes of operation as follows:

- Shared access mode (SAM): This is the normal mode of operation and in this mode both the DSP and host can access the HPI memory. In this case, the asynchronous host accesses are resynchronized internally. In the case of a conflict between the DSP and host, host has access priority and DSP waits 1 cycle. In SAM, the HPI can transfer 1 byte every 5 CLKOUT1 (40 MHz), i.e., 64 Mbps. The HPI is designed such that the host can take advantage of its high bandwidth and can run up to 32 MHz without requiring wait states.
- Host only mode (HOM): In this mode, only the host can access the HPI memory while the DSP is in reset state or IDLE2 with all internal or external clocks stopped. This mode allows host to access the HPI memory while the DSP is in minimum power consumption configuration. In HOM, the HPI supports higher speed back-to-back accesses on the order of 1 byte/50 ns (160 Mbps) independent of the DSP's clock rate.

6.1.2 HPI Functional Description

In C54x, information is exchanged between the host and the DSP via 8-bit external data bus but, because of the 16-bit word structure of the C54, all transfers consist of two consecutive bytes. The dedicated HWIL pin indicates whether the first or second byte is being transferred. Bits 0 and 8 (BOB) in the HPI control register determines whether the first byte is MSB or LSB. The host must not break the first/second byte sequence, otherwise the data may be lost or some unpredictable results may happen.

6.1.3 HPI Registers

The HPI utilizes three registers for communication between the host device and the CPU. These registers are:

- HPI address register (HPIA). It is directly accessible only by the host and contains the address in HPI memory at which the current address access occurs.
- HPI control register (HPIC). It is directly accessed by the host or by C54x and contains the control and status bits for HPI operation.

- HPI data register (HPID). This register is directly accessible by the host and contains the data that was read from the HPI memory if the current access is a read, or the data that will be written to the HPI memory if the current access is a write.

The two control inputs, HCNTL1 and HCNTL0, indicate which internal register is being accessed as shown below.

Table 6–1. C54X HPI Registers Access Control

HCNTL1	HCNTL0	DESCRIPTION
0	0	PCI2040 read/write to HPI control register.
0	1	PCI2040 read/write to HPI data register. Address auto-increment is selected.
1	0	PCI2040 read/write to HPI address register.
1	1	PCI2040 read/write to HPI data register. Address auto-increment is not selected.

HPI control register is a 16-bit register but only 4 bits control the HPI operation. Because the transfer consists of two consecutive half-words, the HPI control register is organized such that it has the same high and low half-word contents. The control and status bits are located on the least significant 4 bits. When the host writes to the HPI control register, both bytes must be the same.

6.2 C54X HPI Control Register

Bit	15	14	13	12	11	10	9	8	7	6	5	4	3	2	1	0
Name	C54X HPI control															
Host Type	R	R	R	R	R/W	W	R	R/W	R	R	R	R	R/W	W	R	R/W
DSP Type	R	R	R	R	R/W	–	R/W	–	R	R	R	R	R/W	–	R/W	–
Default	0	0	0	0	0	0	0	0	0	0	0	0	0	0	0	0

Table 6–2. C54X HPI Control Register Description

BIT	FIELD NAME	HOST TYPE	DSP TYPE	FUNCTION
15–12	RSVD	R	R	Reserved. These bits return 0s when read.
11	HINT	R/W	R/W	This bit determines the state of the DSP $\overline{\text{HINT}}$ output which is used to generate an interrupt to the host. HINT= 0 after reset. The HINT can be set only by the DSP by writing a 1 to this bit and can be cleared only by the host writing a 1 to this bit.
10	DSPINT	W	–	Host to DSP interrupt. This bit can only be written by the host and is not readable by the host or the DSP. When the host writes a 1 to this bit, an interrupt is generated to the DSP. Writing a 0 has no effect.
9	SMOD	R	R/W	This bit determines the mode of operation. 0 = HOM is selected (Always during reset) 1 = SAM is selected
8	BOB	R/W	–	BOB affects both data and address transfers. Only the host can modify this bit and it is not visible to the DSP. BOB must be initialized before the first data or address register access. 0 = First byte is the MS 1 = First byte is the LS
7–4	RSVD	R	R	Reserved. These bits return 0s when read.
3	HINT	R/W	R/W	This bit determines the state of the DSP $\overline{\text{HINT}}$ output which is used to generate an interrupt to the host. HINT= 0 after reset. The HINT can be set only by the DSP by writing a 1 to this bit and can be cleared only by the host writing a 1 to this bit.
2	DSPINT	W	–	Host to DSP interrupt. This bit can only be written by the host and is not readable by the host or the DSP. When the host writes a 1 to this bit, an interrupt is generated to the DSP. Writing a 0 has no effect.
1	SMOD	R	R/W	This bit determines the mode of operation. 0 = HOM is selected (always during reset) 1 = SAM is selected
0	BOB	R/W	–	BOB affects both data and address transfers. Only the host can modify this bit and it is not visible to the DSP. BOB must be initialized before the first data or address register access. 0 = First byte is MS 1 = First byte is the LS

6.2.1 Auto Increment Feature

The HPI data register can be accessed with optional auto-address increment. It provides a convenient way of reading or writing to subsequent word locations. In the auto-increment mode, the data read causes a postincrement of the HPI address register and a data write causes a preincrement of the HPI address register. Because the HPI has 2Kx16-bit memory, it uses only the 11 LSBs of the HPI address register but, during the auto-increment operation, all 16 bits will be incremented or decremented.

6.2.2 Interrupts

DSP can interrupt the host by writing to bit 3 (HINT) of the HPI control register. By writing a 1 by the DSP to the HINT bit of the HPI control register, the HPI can assert its $\overline{\text{HINT}}$ pin that is connected to the $\overline{\text{HINT}}$ pin of PCI2040. The host can acknowledge and clear this bit by writing a 1 to this bit. Writing a 0 to the HINT bit has no effect.

A C54x interrupt is generated when the host writes a 1 to the DSPINT bit (bit 2) of the HPI control register. This interrupt can be used to wake up DSP from IDLE. The host and C54x always read this bit as 0. Once a 1 is written to DSPINT by the host, a 0 need not be written before generating another interrupt. A DSP write or writing a 0 to this bit has no effect.

The host should not write a 1 to the DSPINT bit while writing to BOB or HINT and the DSP should not write a 1 to the HINT bit while writing to SMOD bit or an unwanted interrupt will be generated.

6.2.3 Four Strobes ($\overline{\text{HDS1}}$, $\overline{\text{HDS2}}$, $\text{HR}/\overline{\text{W}}$, $\overline{\text{HAS}}$)

HPI has four strobes and they are:

- Two data strobes ($\overline{\text{HDS1}}$ and $\overline{\text{HDS2}}$)
- Read/write strobe ($\text{HR}/\overline{\text{W}}$)
- Address strobe ($\overline{\text{HAS}}$)

The $\overline{\text{HCS}}$ input serves primarily as the enable input for the HPI and $\overline{\text{HDS1}}$ and $\overline{\text{HDS2}}$ control the HPI data transfer. The equivalent circuit of these three inputs is shown in the figure below. This figure shows that the internal strobe signal that samples the HCNTL1, HCNTL0, HWIL, and $\text{HR}/\overline{\text{W}}$ (when $\overline{\text{HAS}}$ is not used) is derived from all three input signals. So the latest of the $\overline{\text{HCS}}$, $\overline{\text{HDS1}}$, and $\overline{\text{HDS2}}$ control the sampling of these inputs.

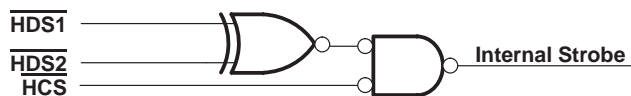

Figure 6–1. C54X Select Input Logic

6.2.4 Wait States

The HPI ready pin (HRDY) allows insertion of wait states to allow deferred completion of access cycles for hosts that have faster cycle times than the HPI can accept due to C54x operating clock rates. The PCI2040 has four HRDY signals, one for each DSP. The HRDY signal will automatically adjust the host access rate to a faster DSP clock rate or switch the HPI mode (to HOM) for faster access.

6.2.5 Host Read/Write Access to HPI

The host begins accessing the HPI interface first by initializing the HPI control register, then by initializing the HPI address register, and then by reading data from or writing data to the HPI data register. Writing to the HPI address or HPI data register initiates an internal cycle that transfers the desired data between the HPI data register and the internal HPI memory. This process may take several cycles. Each time an access is made, data written to HPI data register is not written to HPI memory until after the host access cycle and the data read from HPI data register is the data from the previous cycle. Therefore, when reading, the data is obtained from the location specified in the previous access and the current access serves as an initiation of the next cycle. A similar operation occurs for the write operation. The data written to the HPI data register is not written to HPI memory until after the external cycle is completed. If the HPI data register read operation immediately follows an HPI data register write operation, then the same data (the data written) is read.

During random transfers or sequential transfers selected with auto-increment with a significant amount of time between them, the HPI address register must be either rewritten, or two reads from the same location must be done, or an address write prior to read must be made to ensure that the most recent data is read because the DSP may have changed the contents of the location being accessed.

In SAM, the HRDY signal is used to insert wait states if necessary. However, this signal is inactive in HOM. Unless back-to-back transfers are being performed, HRDY signal is normally high when the first byte of the cycle is transferred. HRDY is always high when $\overline{\text{HCS}}$ is high and it is not used and stays high in SAM when reading the HPI control or HPI address register or writing to the HPI control register (except writing a 1 to either DSPINT or HINT).

6.2.6 HPI Memory Access During Reset

The DSP is not operational during reset, but the host can access the HPI hereby allowing the program or data to be downloaded to the HPI memory. However to use this capability, it is convenient for the host to control the DSP's reset. Initially, the host stops accessing the HPI at least six DSP periods before driving the DSP reset line low. The HPI mode is set to HOM during the reset and the host can start accessing the HPI after four DSP periods.

Once the host has finished downloading into the HPI memory, the host stops accessing the HPI and drives the C5x reset line. At least 20 clock periods after the reset line rising high, the host can again start accessing the HPI. HPI mode is automatically set to SAM upon exiting reset.

6.2.7 Examples of Transactions Targeting the C54X

In order to describe how the PCI2040 translates PCI cycles into 8-bit host port transactions the following examples are provided. In each example, the following information is common:

1. The control space base address (PCI offset 14h) contains FFEF0000h.
2. There are four TMS320C5410s behind the PCI2040.

6.2.7.1 PCI Word Write

In the first example depicted in Figure 6–2, a PCI write transaction with address FFEF1800, byte enables of 1100b, and a single data phase of the PCI bus occurs. The data is DDCCBBAAh. The PCI2040 takes this PCI transaction and translates it to an 8-bit host port transaction. The event flow is as follows:

1. The host port is idle.
2. HCNTL0 and HCNTL1 are driven high indicating to the C5410 that this transaction is going to target the HPID without auto-increment enabled. The $\overline{\text{HR}}/\overline{\text{W}}$ is driven low indicating to the C5410 that this transaction is a write.
3. $\overline{\text{HCS}}_0$ is asserted indicating that this transaction is targeting DSP0. The first byte or half-word is driven onto the HAD bus. Notice the upper eight data lines (HAD15–HAD8) are not used. Only the lower eight data lines are used when communicating with the C5410. Also, during clock 3, the $\overline{\text{HDS}}$ is asserted. During this time, the C5410 latches the values of HCNTL1, HCNTL0, HWIL, and $\overline{\text{HR}}/\overline{\text{W}}$.
4. The PCI2040 samples the state of HRDY5X0. If the C5410 indicates it is not ready, then the PCI2040 waits until the C5410 indicates it is ready before it deasserts $\overline{\text{HDS}}$ and HWIL.
5. Because the state of the HRDY5X0 signal indicates the C5410 is ready, the PCI2040 deasserts $\overline{\text{HDS}}$. The C5410 latches the data, AAh, on the rising edge of $\overline{\text{HDS}}$. The HWIL is driven high.
6. During clock 6, the PCI2040 starts driving the second byte or half word onto the HAD bus. Please note that the PCI bus uses little endian notation. For this reason, the PCI2040 transfers the least significant byte first followed by the next least significant byte.
7. Same as Step 4.
8. Same as Step 5 except the data latched is BBh and the $\overline{\text{HCS}}_0$ is deasserted indicating the end of the transaction.

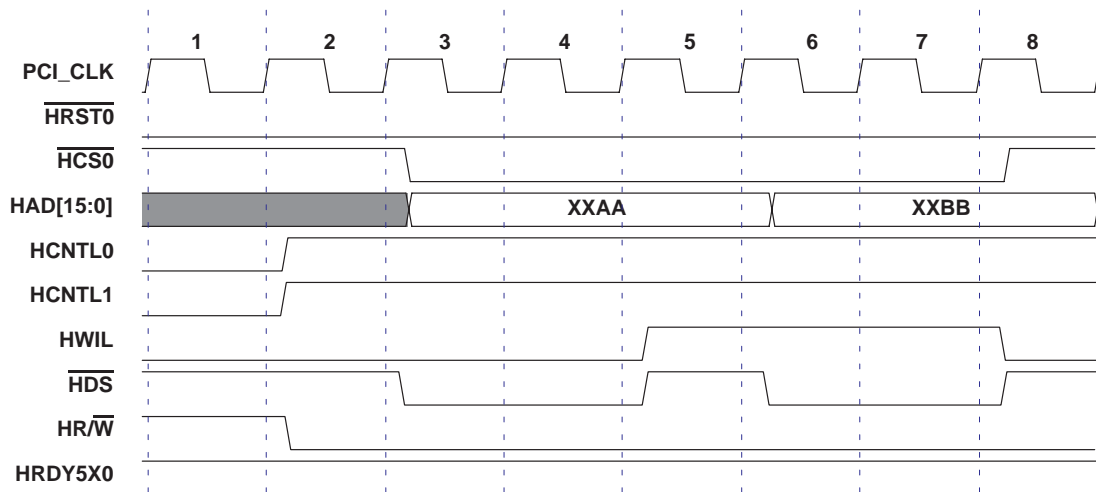

Figure 6–2. Word Write To HPID Without Auto-Increment Enabled

6.2.7.2 PCI Word Read

The second example outlined in Figure 6–3 shows how the PCI2040 translates a word read on the PCI bus with a PCI address of FFEF5800h. The event flow is as follows:

1. The host port is idle.
2. HCNTL0 and HCNTL1 are driven high indicating to the C5410 that this transaction is going to target the HPID without auto-increment enabled. The $\overline{\text{HR}}/\overline{\text{W}}$ is driven high indicating to the C5410 that this transaction is a read.
3. $\overline{\text{HCS}}_2$ is asserted indicating that this transaction is targeting DSP0. The first byte or half-word is driven onto the HAD bus. Also during clock 3 the $\overline{\text{HDS}}$ is asserted. During this time, the C5410 latches the values of HCNTL1, HCNTL0, HWIL, and $\overline{\text{HR}}/\overline{\text{W}}$.
4. The PCI2040 samples the state of HRDY5X0. If the C5410 indicates it is not ready, then the PCI2040 waits until the C5410 indicates it is ready before it deasserts $\overline{\text{HDS}}$ and HWIL. In this case, the C5410 is not ready.
5. Same as Step 4 but in this case the C5410 is ready.
6. The PCI2040 drives both $\overline{\text{HDS}}$ and HWIL high. The PCI2040 also latches the data on the lower eight data lines (HAD7–HAD0).
7. Same as Step 3.
8. Same as Step 5.
9. Same as Step 6 except the data latched is BBh and $\overline{\text{HCS}}_2$ is deasserted indicating the end of the transaction. The PCI2040 then places XXXXBBAAh on the PCI bus.

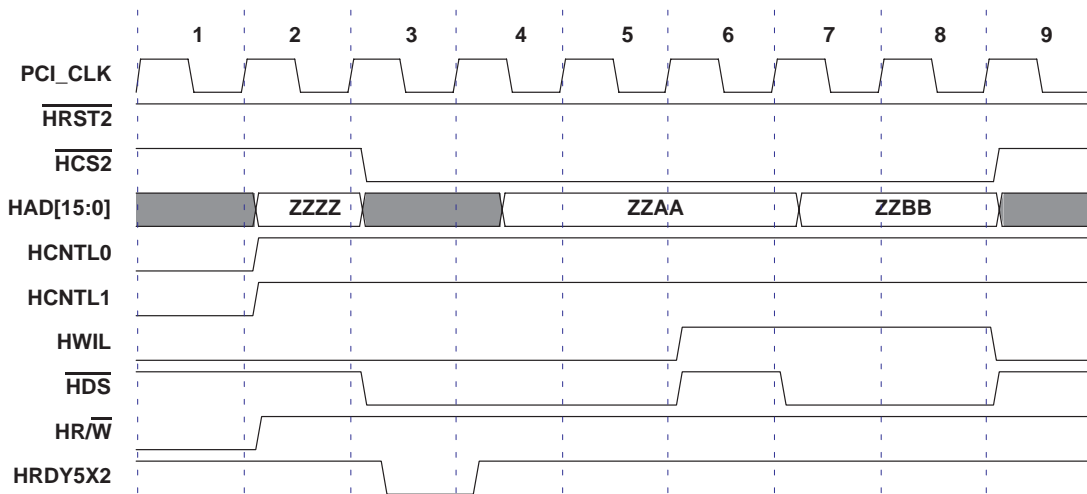

Figure 6–3. Word Write From HPID Without Auto-Increment Enabled

6.2.7.3 PCI Double Word Write

In the third example depicted in Figure 6–4, a PCI write transaction with address FFEF3800, byte enables of 0000b, and a single data phase occurs of the PCI bus. The data is DDCCBBAAh. The PCI2040 takes this PCI transaction and translates it to an 8-bit host port transaction. This example is a little different than a normal write due to the fact that this PCI transaction is specifying a write to HPID without auto-increment selected. Typically, when performing a doubleword read or write to the HPID, the PCI address should specify HPID with auto-increment selected. Because auto-increment was not selected, the PCI2040 attempts to place the data in two different locations in the DSP's memory. The event flow is as follows:

1. The host port is idle.
2. HCNTL0 and HCNTL1 are driven high indicating to the C5410 that this transaction is going to target the HPID without auto-increment enabled. The HR/W is driven low indicating to the C5410 that this transaction is a write.
3. HCS1 is asserted indicating that this transaction is targeting DSP1. The first byte or half-word is driven onto the HAD bus. Also during clock 3 the HDS is asserted. During this time, the C5410 latches the values of HCNTL1, HCNTL0, HWIL, and HR/W.
4. The PCI2040 samples the state of HRDY5X0. If the C5410 indicates it is not ready, then the PCI2040 waits until the C5410 indicates it is ready before it deasserts HDS and HWIL.
5. Because the state of the HRDY5X0 signal indicates the C5410 is ready, the PCI2040 deasserts HDS. The C5410 latches the data, AAh, on the rising edge of HDS. The HWIL is driven high.
6. Same as Step 3.
7. Same as Step 4 except the HCNTL1 is driven low. Because a write to the HPID with auto-increment select will pre-increment the HPIA, the HCNTL1 is driven low to increment the HPIA. This places the most significant word of the PCI data to a different location in the DSP's memory than the least significant word was placed.
8. Same as Step 5 except the data latched by the C5410 is BBh.
9. Same as Step 3.
10. Same as Step 4.
11. Same as Step 5 except the data latched by the C5410 is CCh.

- 12. Same as Step 3.
- 13. Same as Step 4.
- 14. Same as Step 5 except the data latched is DDh and the $\overline{\text{HCS1}}$ is deasserted indicating the end of the transaction.

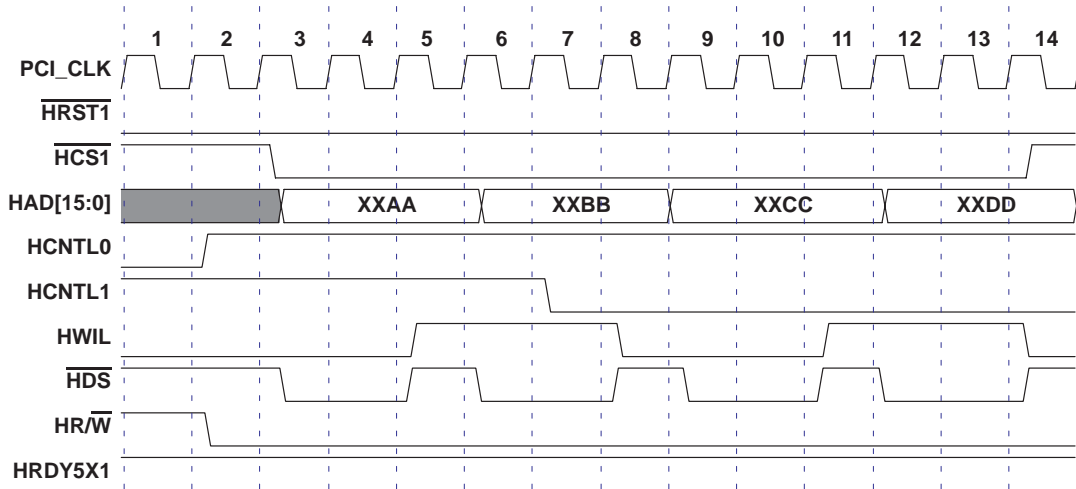

Figure 6–4. Doubleword Write To HPID Without Auto-Increment Enabled

6.2.7.4 PCI Double Word Read

The fourth example is very similar to the third example. In this case the transaction is a PCI doubleword read. The steps involved in performing this translation are very similar to the doubleword write example. The important thing to note is a read from the HPID with auto-increment selected causes the HPIA to be post-incremented.

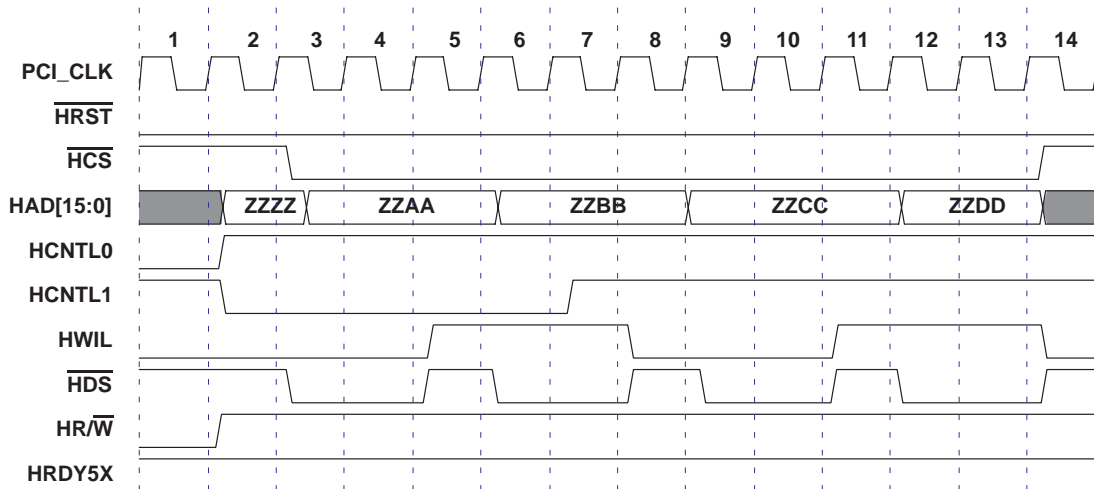

Figure 6–5. Doubleword Read From HPID Without Auto-Increment Enabled

6.3 C6X HPI Interface

The HPI interface for C6x is similar to C54x HPI port except for the following:

6.3.1 No SAM or HOM Modes

The C6x HPI interface has only one mode of operation which does not support C54x SAM or HOM.

6.3.2 Address/Data Bus

The HPI provides 32-bit data to the CPU with a 16-bit wide parallel external interface (C54x has 8-bit wide external interface). All transfers with the host consist of two consecutive half-words. On the HPI data register data write access, $\overline{\text{HBE1}}$ and $\overline{\text{HBE0}}$ (byte enables) select the bytes in 32-bit word to be written. For the HPI address register, HPI control register, and HPI data register read, byte enables are not used. The HWIL pin determines whether the first or second byte is being transferred and HWOB bit in the HPI control register (see Section 6.3.5) determines whether the first half-word is most significant or least significant. The host must not break the first half-word/second half-word sequence or data may be lost, in the case of full word access.

6.3.3 Byte Enables ($\overline{\text{HBE0}}$ and $\overline{\text{HBE1}}$)

On the HPI data register writes, the value of $\overline{\text{HBE0}}$ and $\overline{\text{HBE1}}$ indicate which bytes of the 32-bit word are written. The value of byte enables, as mentioned earlier, is not important on HPI address or HPI control register accesses and HPI data register reads. On HPI data register writes, the $\overline{\text{HBE0}}$ enables the least significant byte in the half-word while $\overline{\text{HBE1}}$ determines the most significant byte in the half-word. Following combinations for the $\overline{\text{HBE0}}/\overline{\text{HBE1}}$ are allowed:

- For byte writes, one $\overline{\text{HBE}n}$ in either of the half-word accesses can be enabled.
- For half-word writes, both $\overline{\text{HBE0}}$ and $\overline{\text{HBE1}}$ must be active low in either half-word access (but not both half-words).
- For complete word writes, both $\overline{\text{HBE0}}$ and $\overline{\text{HBE1}}$ must be held active low in both half-word accesses
- No other combinations are valid.

6.3.4 Wait States

In C6x based systems, wait states can be inserted either using $\overline{\text{HRDY}}$ signal as in the case of C54X, or using the HRDY bit in the HPI control register (see Section 6.3.5).

6.3.5 C6X HPI Registers

C6x contains HPI address, HPI control, and HPI data registers, and these registers have a 32-bit structure as opposed to the 16-bit structure in the C54x HPI interface.

The HCNTL0/1 control access to the HPI registers as described below. Note that it is different from C54x.

Table 6–3. HCNTL0 and HCNTL1 in C6X

HCNTL1	HCNTL0	DESCRIPTION
0	0	PCI2040 read/write to HPI control register
0	1	PCI2040 read/write to HPI address register
1	0	PCI2040 read/write to HPI data register. Address auto-increment is selected.
1	1	PCI2040 read/write to HPI data register. Address auto-increment is not selected.

Bit	31	30	29	28	27	26	25	24	23	22	21	20	19	18	17	16
Name	C6X HPI control															
Host Type	R	R	R	R	R	R	R	R	R	R	R	R/W	R	R/W	R/W	R/W
DSP Type	R	R	R	R	R	R	R	R	R	R	R	R	R	R/W	R	R
Default	0	0	0	0	0	0	0	0	0	0	0	0	0	1	1	1
Bit	15	14	13	12	11	10	9	8	7	6	5	4	3	2	1	0
Name	C6X HPI control															
Host Type	R	R	R	R	R	R	R	R	R	R	R	R/W	R	R/W	R/W	R/W
DSP Type	R	R	R	R	R	R	R	R	R	R	R	R	R	R/W	R	R
Default	0	0	0	0	0	0	0	0	0	0	0	0	0	0	0	0

Table 6–4. C6X HPI Control Register

BIT	FIELD NAME	HOST TYPE	DSP TYPE	FUNCTION
31–21	RSVD	R	R	Reserved. Bits 31–21 return 0s when read.
20	FETCH			Host fetch request. The value read by the host or the CPU is always 0. Only host can write to this register. When host writes 1 to this bit, it requests a fetch into HPI data register of the word at the word pointed to by HPI address register. Note that the value of 1 is never actually written to this bit.
19	HRDY			Ready signal to host. It is not masked by the \overline{HCS} as the \overline{HRDY} pin is. 0 = Host is busy; the internal bus is waiting for an HPI data request to finish. 1 = Host is ready to transfer data
18	HINT			DSP-to-host interrupt. The inverted value of this bit determines the state of the \overline{HINT} output.
17	DSPINT			Host-to-DSP interrupt.
16	HWOB			HWOB affects both data and address transfers. Only the host can modify this bit and it is read-only to the DSP. HWOB must be initialized before the first data or address register access. 0 = First byte is the MS 1 = First byte is the LS
15–5	RSVD	R	R	Reserved. Bits 15–5 return 0s when read.
4	FETCH			Host fetch request. The value read by the host or the CPU is always is 0. Only host can write to this register. When host writes 1 to this bit, it requests a fetch into HPI data register of the word at the word pointed to by HPI address register. Note that the value of 1 is never actually written to this bit.
3	HRDY			Ready signal to host. It is not masked by the \overline{HCS} as the \overline{HRDY} pin is. 0 = Host is busy; the internal bus is waiting for an HPI data request to finish. 1 = Host is ready to transfer data
2	HINT			DSP-to-host interrupt. The inverted value of this bit determines the state of the \overline{HINT} output.
1	DSPINT			Host-to-DSP interrupt.
0	HWOB			HWOB affects both data and address transfers. Only the host can modify this bit and it is read-only to the DSP. HWOB must be initialized before the first data or address register access. 0 = First byte is the MS 1 = First byte is the LS

6.3.6 Software Handshaking Using HRDY and FETCH

Software handshaking using HRDY and FETCH bits in the HPI control register is a C6x feature not supported in PCI2040 because it will support \overline{HRDY} pin from DSP to host for insertion of wait states.

6.3.7 Host Access Sequence

The host access sequence in C6x is similar to C54x except for the HPI data register write. The host begins accessing HPI by initializing the HPI control register, then by initializing the HPI address register, and then by writing data to or reading data from the HPI data register. Reading or writing to the HPI data register initiates an internal cycle that transfers the desired data between the HPI data register and DMA auxiliary channel. Typically, host does not break the first half-word/second half-word sequence. If this sequence is broken, then the data is lost. During the HPI data register write however, $\overline{HBE0}/\overline{HBE1}$ enable the individual bytes in the half-word. Please see Section 6.3.3, *Byte Enables ($\overline{HBE0}$ and $\overline{HBE1}$)*, for more details.

6.3.8 Single Half-Word Cycles

In the normal operation, every transfer must consist of two half-word accesses. However, to speed the operation, the C6x allows single half-word accesses. The PCI2040 does not support the half-word cycles.

6.3.9 Memory Access Through HPI During Reset

During the reset, when \overline{HCS} is active low and \overline{HRDY} is inactive high, and vice versa, the HPI can not be used but certain boot modes can allow the host to write to the CPU's memory space including configuring the EMIF configuration registers to define external memory before accessing it. Note that the device is not in reset during these boot modes but the CPU itself is in reset until the boot completes.

6.3.10 Examples of Transactions Targeting the C6X

The following two figures depict typical transactions on the HPI bus which are targeting a C6X. Both of these figures are very similar with one being a write transaction and the other being a read transaction. Because both transactions are similar, the following event flow can be used to describe both transactions.

1. The host port is idle.
2. $\overline{HCNTL0}$ and $\overline{HCNTL1}$ are driven high indicating to the C6X that this transaction is going to target the HPID w/o auto-increment enabled. The $\overline{HR/W}$ is driven low indicating to the C6X that this transaction is a write.
3. $\overline{HCS0}$ is asserted indicating that this transaction is targeting DSP0. The first two bytes or half-word is driven onto the HAD bus. Both $\overline{HBE1}$ and $\overline{HBE0}$ are driven low. Also during clock 3 the \overline{HDS} is asserted. During this time, the C6X will latch the values of $\overline{HCNTL1}$, $\overline{HCNTL0}$, \overline{HWIL} , and $\overline{HR/W}$.
4. The PCI2040 will sample the state of $\overline{HRDY6X0}$. If the C6X indicates it is not ready, then the PCI2040 will wait until the C6X indicates it is ready before it deasserts \overline{HDS} and \overline{HWIL} .
5. Because the state of the $\overline{HRDY6X0}$ signal indicates the C6X is ready, the PCI2040 deasserts \overline{HDS} . The C6X latches the data, BBAAh, on the rising edge of \overline{HDS} . The \overline{HWIL} is driven high. The C6X also latches the value of $\overline{HBE1}$ and $\overline{HBE0}$. In this example, both these signals are low indicating to the C6X that both bytes of the half-word are valid.
6. Same as Step 3.
7. Same as Step 4.
8. Same as Step 5 except $\overline{HCS0}$ is deasserted indicating the transaction has completed.

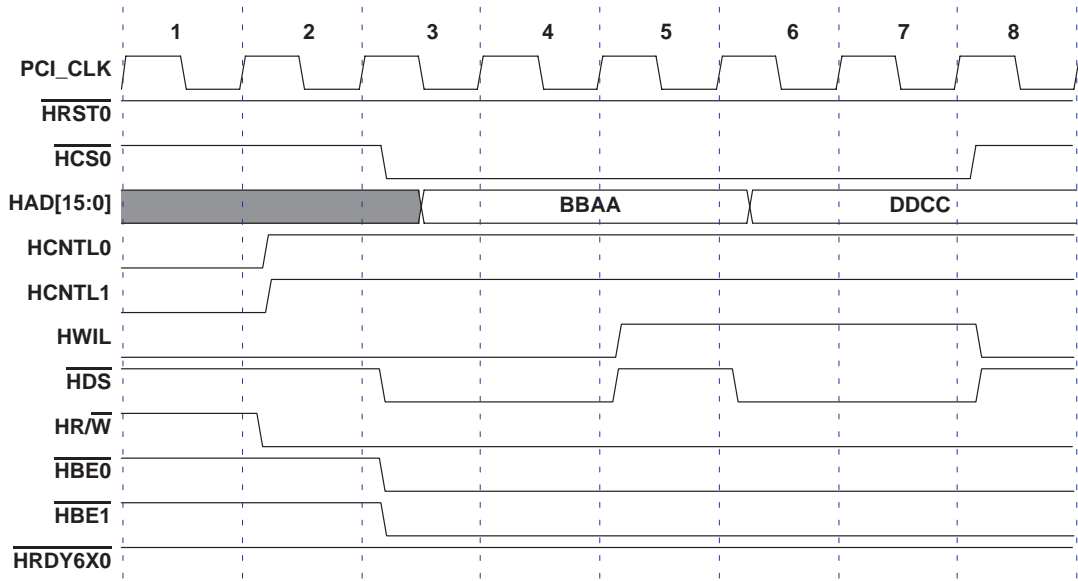

Figure 6–6. Double Word Write To HPID Without Auto-Increment Selected

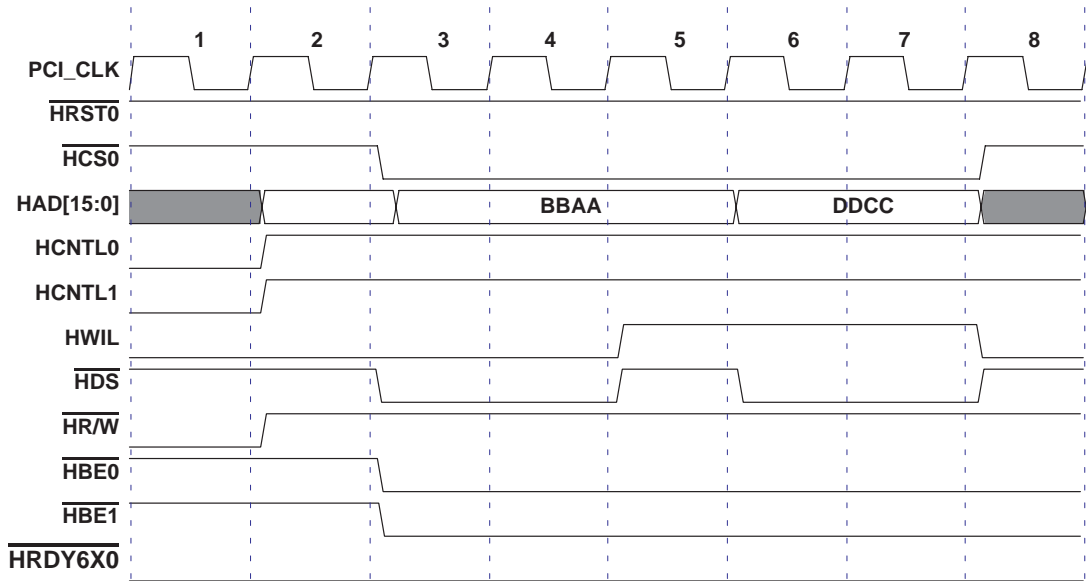

Figure 6–7. Double Word Read From HPID Without Auto-Increment Selected

7 Electrical Characteristics

7.1 Absolute Maximum Ratings Over Operating Temperature Ranges†

Supply voltage range, V_{CC}	-0.5 V to 3.6 V
Supply voltage range, V_{CCP}	-0.5 V to 5.5 V
Supply voltage range, V_{CCH}	-0.5 V to 5.5 V
Input voltage range, V_I : PCI	-0.5 V to $V_{CCP} + 0.5$ V
HPI	-0.5 to $V_{CCH} + 0.5$ V
Output voltage range, V_O : PCI	-0.5 V to $V_{CCP} + 0.5$ V
HPI	-0.5 to $V_{CCH} + 0.5$ V
Miscellaneous	-0.5 to $V_{CCH} + 0.5$ V
Fail safe	-0.5 V to $V_{CC} + 0.5$ V
Input clamp current, I_{IK} ($V_I < 0$ or $V_I > V_{CC}$) (see Note 1)	± 20 mA
Output clamp current, I_{OK} ($V_O < 0$ or $V_O > V_{CC}$) (see Note 2)	± 20 mA
Storage temperature range, T_{stg}	-65°C to 150°C
Virtual junction temperature, T_J	150°C

† Stresses beyond those listed under “absolute maximum ratings” may cause permanent damage to the device. These are stress ratings only and functional operation of the device at these or any other conditions beyond those indicated under “recommended operating conditions” is not implied. Exposure to absolute-maximum-rated conditions for extended periods may affect device reliability.

- NOTES: 1. Applies to external input and bidirectional buffers. For 5V tolerant, use $V_I > V_{CCH}$. For universal PCI, use $V_I > V_{CCP}$.
 2. Applies to external output and bidirectional buffers. For 5V tolerant, use $V_I > V_{CCH}$. For universal PCI, use $V_I > V_{CCP}$.

7.2 Recommended Operating Conditions (see Note 3)

			OPERATION	MIN	NOM	MAX	UNIT
V _{CC}	Core voltage	Commercial	3.3 V	3	3.3	3.6	V
V _{CCP}	PCI I/O voltage	Commercial	3.3 V	3	3.3	3.6	V
			5 V	3	5	5.25	
V _{CCH}	HPI I/O voltage	Commercial	3.3 V	3	3.3	3.6	V
			5 V	3	5	5.25	
V _{IH} [†]	High-level input voltage	PCI	3.3 V	0.5 V _{CCP}	V _{CCP}		V
			5 V	2	V _{CCP}		
		HPI		2	V _{CCH}		
V _{IL} [†]	Low-level input voltage	PCI	3.3 V	0	0.3 V _{CCP}		V
			5 V	0	0.8		
		HPI		0	0.8		
V _I	Input voltage	PCI		0	V _{CCP}		V
		HPI		0	V _{CCH}		
V _O [‡]	Output voltage			0	V _{CC}		V
t _t	Input transition time (t _r and t _f)	PCI		1	4		ns
		HPI		0	6		
T _A	Operating ambient temperature range			0	25	70	°C
T _J [§]	Virtual junction temperature			0	25	115	°C

[†] Applies to external inputs and bidirectional buffers without hysteresis

[‡] Applies to external output buffers

[§] These junction temperatures reflect simulation conditions. The customer is responsible for verifying junction temperature.

NOTE 3: Unused pins (input or I/O) must be held high or low to prevent them from floating.

7.3 Electrical Characteristics Over Recommended Operating Conditions (unless otherwise noted)

PARAMETER	PINS	OPERATION	TEST CONDITIONS	MIN	MAX	UNIT
V _{OH} High-level output voltage [†]	PCI	3.3 V	I _{OH} = -0.5 mA	0.9 V _{CC}		V
		5 V	I _{OH} = -2 mA	2.4		
	HPI [‡]		I _{OH} = -8 mA	V _{CC} -0.6		
	Miscellaneous [§]		I _{OH} = -4 mA	V _{CC} -0.6		
V _{OL} Low-level output voltage	PCI	3.3 V	I _{OL} = 1.5 mA	0.1 V _{CC}		V
		5 V	I _{OL} = 6 mA	0.55		
	HPI [‡]		I _{OL} = 8 mA	0.5		
	Miscellaneous [§] / Failsafe [¶]		I _{OL} = 4 mA	0.5		
I _{OZH} 3-state output, high-impedance state current	PCI/HPI	3.6 V	V _I = V _{CC}		10	V
		5.5 V	V _I = V _{CC}		20	
	Failsafe	3.6 V	V _I = V _{CC}		10	μA
I _{OZL} 3-state output, high-impedance state current	Output only pins		V _I = GND		-10	μA
I _{IH} [#] High-level input current	Input only and I/O pins	3.6 V	V _I = V _{CC}		10	μA
		5.5 V	V _I = V _{CC}		20	
I _{IL} [#] Low-level input current	Input only pins		V _I = GND		-1	μA
	I/O pins		V _I = GND		-10	

[†] V_{OH} is not tested on PCI_SERR, PCI_INTA, PME, and HSENUM due to open-drain configuration.

[‡] HPI pins are all other TTL/LVCMOS pins.

[§] TTL/LVCMOS pins are GP_RST, HCS3-HCS0, and HRST3-HRST0.

[¶] Failsafe pins are PME and HSENUM.

[#] For I/O pins, input leakage (I_{IL} and I_{IH}) includes I_{OZ} leakage of the disabled output.

8 Mechanical Information

The PCI2040 is packaged in either a 144-ball GGU BGA or a 144-pin PGE package. The following shows the mechanical dimensions for the GGU and PGE packages.

GGU (S-PBGA-N144)

PLASTIC BALL GRID ARRAY

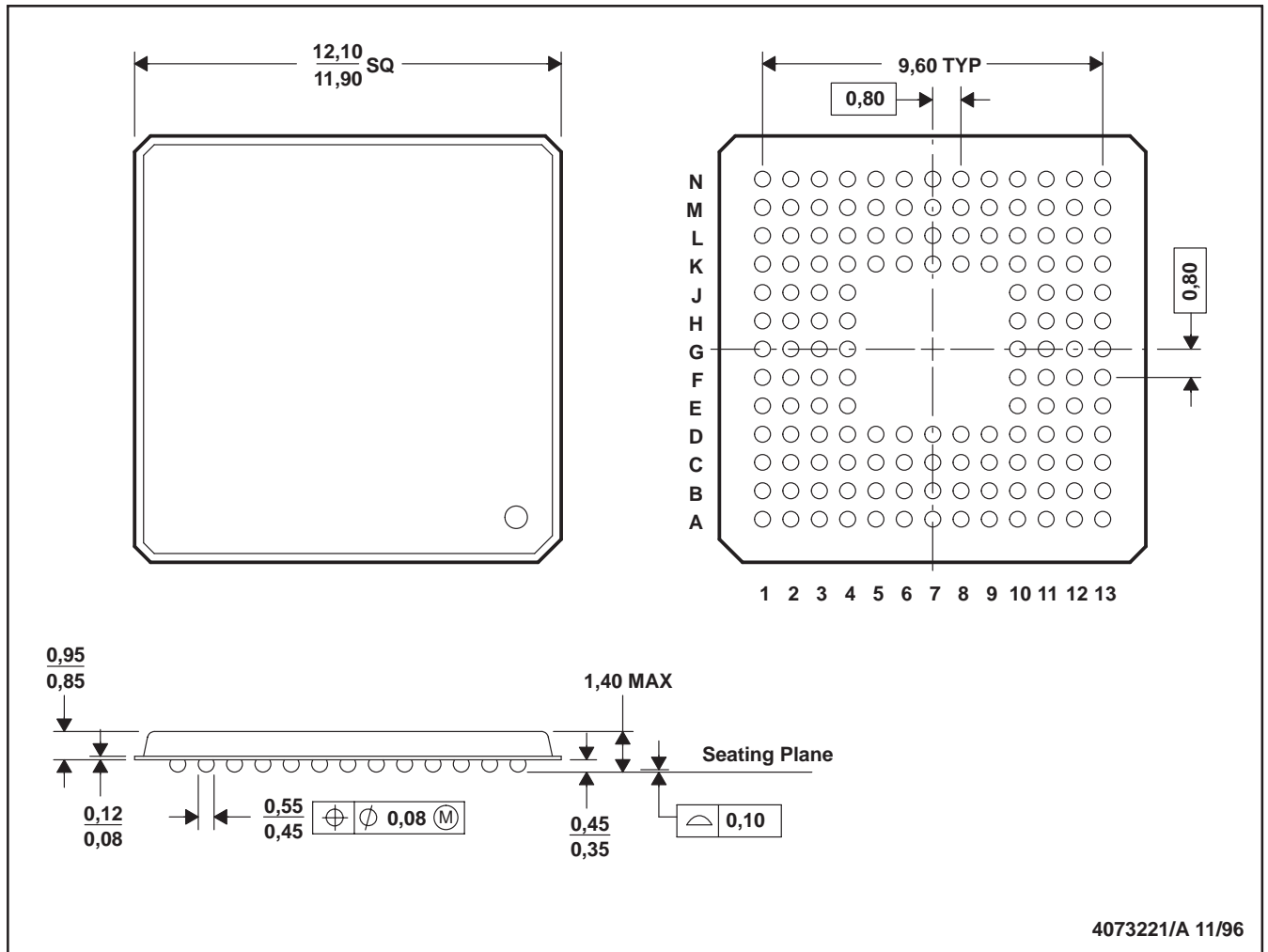

- NOTES: A. All linear dimensions are in millimeters.
 B. This drawing is subject to change without notice.
 C. Micro Star™ BGA configuration

Micro Star is a trademark of Texas Instruments Incorporated.

PGE (S-PQFP-G144)

PLASTIC QUAD FLATPACK

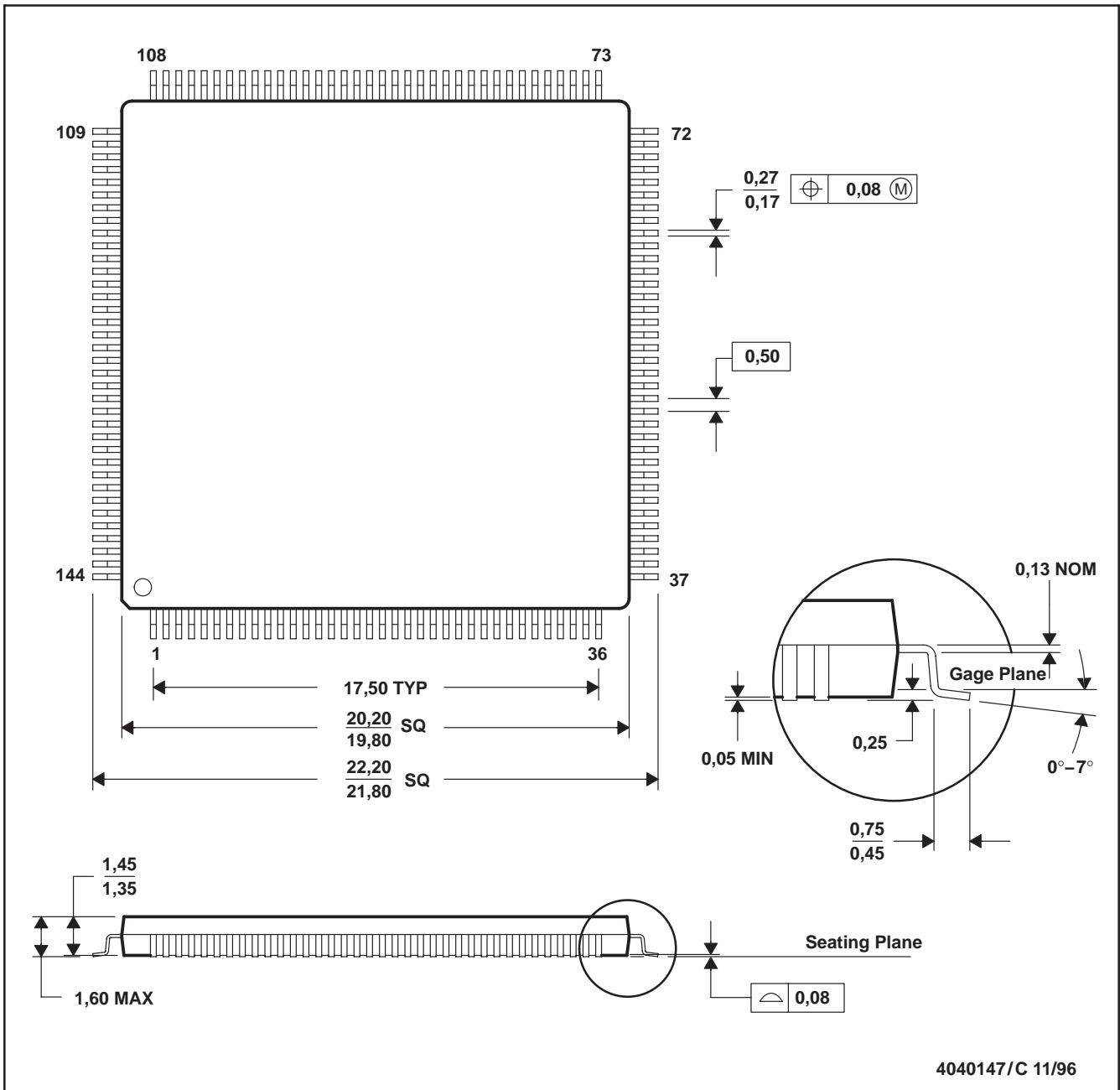

- NOTES: A. All linear dimensions are in millimeters.
 B. This drawing is subject to change without notice.
 C. Falls within JEDEC MS-026