

HP - 202

The HP - 202 is a high - output, high - speed silicon photodiode, mounted in durable hermetically sealed TO - 5 metal can package, which provides years of reliable performance even under demanding conditions such as use outdoors.

FEATURES

- High - output power
- High - speed response
- Durable
- High reliability in demanding environments

APPLICATIONS

- Optical detectors
- Optical switches
- Smoke detectors

DIMENSIONS

(Unit : mm)

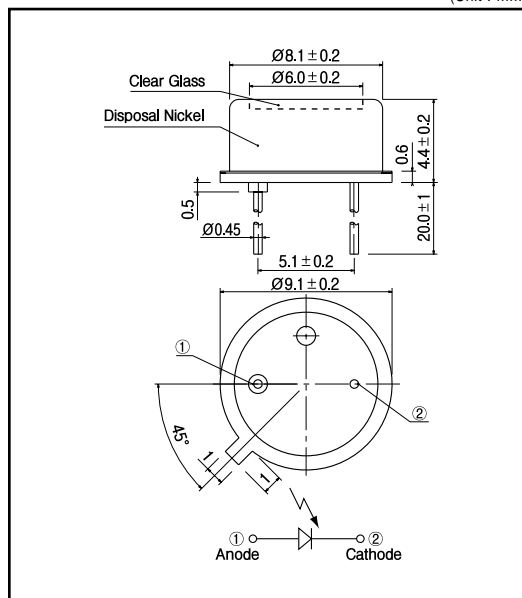

MAXIMUM RATINGS

(Ta=25)

Item	Symbol	Rating	Unit
Reverse voltage	V _r	10	V
Operating temp.	T _{opr.}	- 25 ~ + 100	
Storage temp.	T _{stg.}	- 30 ~ + 100	
Soldering temp. *1	T _{sol.}	260	

*1. For MAX.5 seconds at the position of 2 mm from the package

ELECTRO-OPTICAL CHARACTERISTICS

(Ta=25)

Item	Symbol	Conditions	Min.	Typ.	Max.	Unit.
Open circuit voltage	V _{oc}	E _v = 1,000lx ⁻²		0.3		V
Short circuit current	I _{sc}			65		μA
Dark current	I _d	V _r = 10V			0.1	μA
Curve factor	C.F.		0.55			-
Capacitance	C _t	V = 0V, f = 1MHz		155		pF
Temperature coefficient of V _{oc}	t			- 2.2		mV/
Temperature coefficient of I _{sc}	t			0.18		%/
Spectral sensitivity				450 ~ 1,050		nm
Peak wavelength	ρ			900		nm
Half angle				± 55		deg.

*2. Color temp. = 2856K standard Tungsten lamp

Photo diodes

HP - 202

Light current Vs. Forward voltage

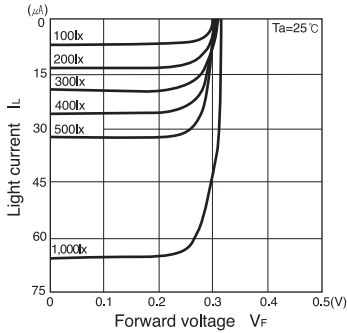

Short circuit current Vs. Illuminance

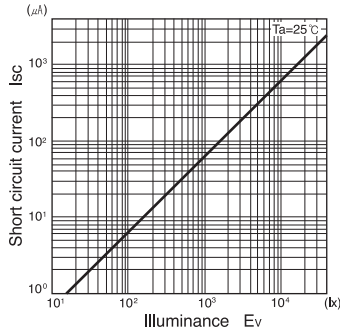

Dark current Vs. Ambient temperature

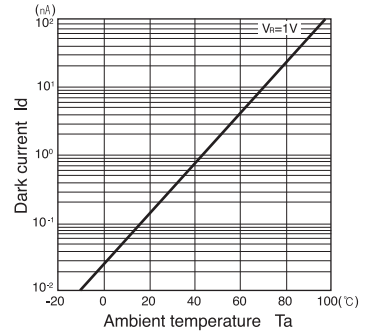

Relative sensitivity Vs. Wavelength

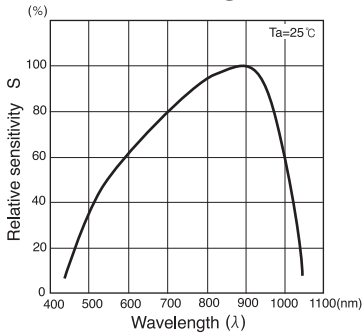

Dark current Vs. Reverse voltage

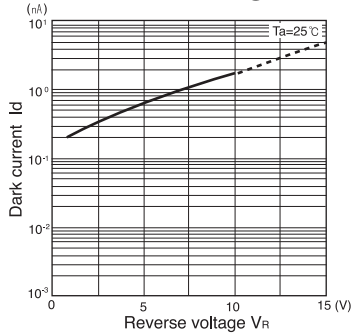

Radiant Pattern

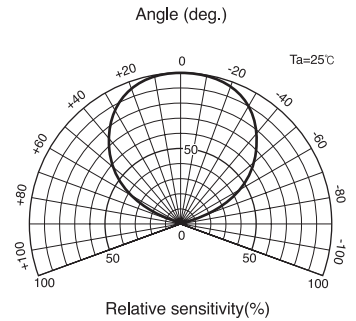

Capacitance between terminals Vs. Reverse voltage

