

PC-17K1 • PC-17K2 • PC-17K4

These Photocouplers consist of a Gallium Arsenide Infrared Emitting Diode and a Silicon NPN Phototransistor per a channel
 The PC-17K1 has one channel in a 4-pin DIP package
 The PC-17K2 has two channels in a 8-pin DIP package
 The PC-17K4 has four channels in a 16-pin DIP package

FEATURES

- Small Package Size
- Collector-Emitter Voltage : Min.35V
- Current Transfer Ratio : Min.50% (at $I_F=5mA, V_{CE}=5V$)
- Electrical Isolation Voltage : AC5000Vrms
- Creepage/Clearance between Input and Output : Min. 7.0mm
- UL Recognized File No. E107486

APPLICATIONS

- Interface between two circuits of different potential
- Vending Machine, Cordless Phone, Key Phone, Fax, Motor Control
- Programmable Logic Control
- Power Supply
- Computer Terminals

DIMENSION

(Unit : mm)

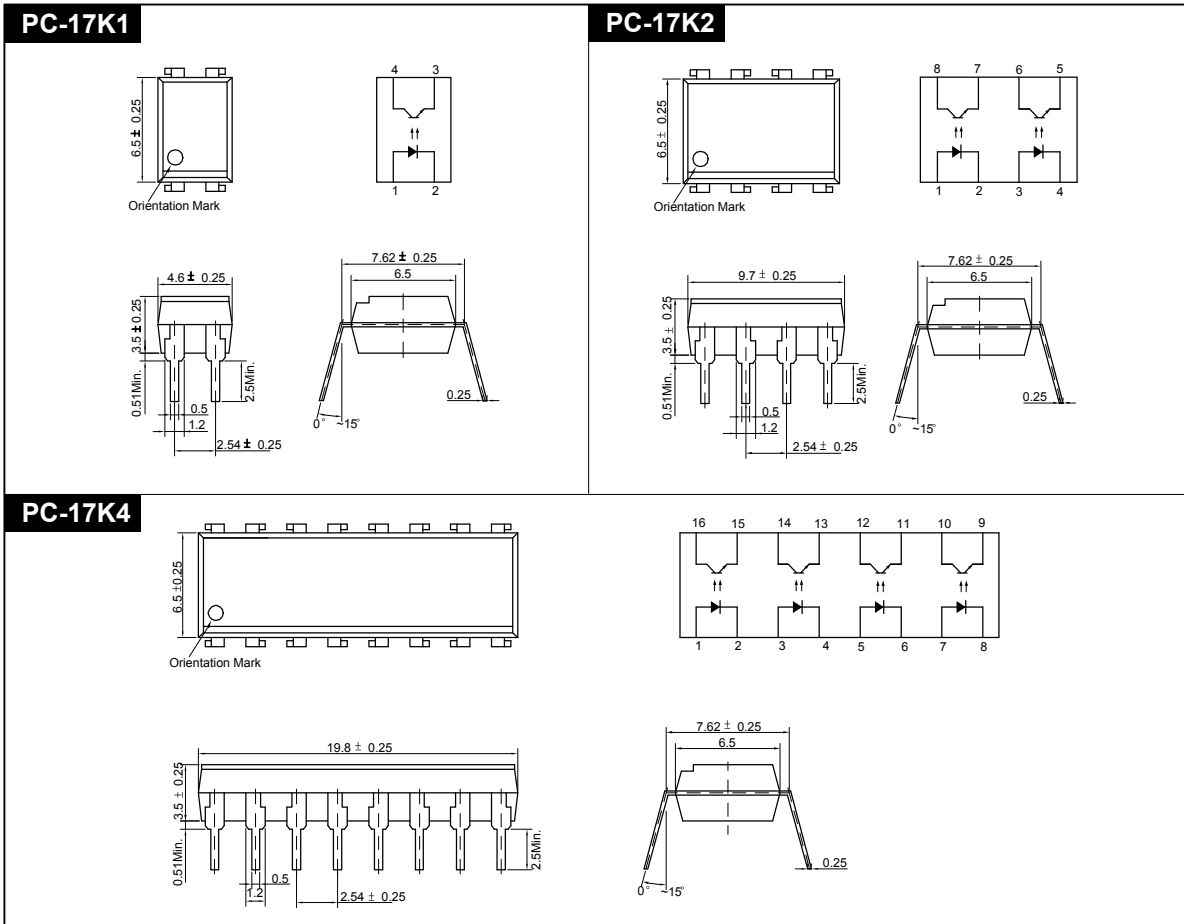

PC-17K1 • PC-17K2 • PC-17K4

MAXIMUM RATINGS

(Ta=25°C)

Parameter		Symbol	Rating	Unit
Input	Forward Current	IF	50	mA
	Reverse Voltage	VR	5	V
	Peak Forward Current ^{*1}	IFP	1	A
	Power Dissipation	PD	70	mW
Output	Collector-Emitter Breakdown Voltage	BVCEO	35 ^{*4}	V
	Emitter-Collector Breakdown Voltage	BVECO	6	V
	Collector Current	IC	50	mA
	Collector Power Dissipation	PC	150	mW
Input to Output Isolation Voltage ^{*2}		Viso	AC5000	Vrms
Storage Temperature		Tstg	-55~+125	°C
Operating Temperature		Topr	-30~+100	°C
Lead Soldering Temperature ^{*3}		Tsol	260	°C
Total Power Dissipation		Ptot	200	mW

*1. Input current with 100 μ s pulse width, 1% duty cycle

*2. Measured at RH=40~60% for 1min

*3. 1/16 inch form case for 10sec

*4. Customer Option

ELECTRO-OPTICAL CHARACTERISTICS

(Ta=25°C, unless otherwise noted)

Parameter		Symbol	Condition	Min.	Typ.	Max.	Unit.
Input	Forward Voltage	VF	IF=10mA	-	1.15	1.30	V
	Reverse Current	IR	VR=5V	-	-	10	μ A
	Capacitance	CT	V=0, f=1MHz	-	30	-	pF
Output	Collector-Emitter Breakdown Voltage	BVCEO	IC=0.5mA	35	-	-	V
	Emitter-Collector Breakdown Voltage	BVECO	IE=0.1mA	6	-	-	V
	Collector Dark Current	ICEO	IF=0, VCE=24V	-	-	100	nA
	Capacitance	CCE	VCE=0, f=1MHz	-	10	-	pF
Coupled	Current Transfer Ratio ^{*5}	CTR	IF=5mA, VCE=5V	50	-	600	%
	Collector-Emitter Saturation Voltage	VCE(SAT)	IF=5mA, IC=1mA	-	0.15	0.4	V
	Input-Output Capacitance	CIO	V=0, f=1MHz	-	1	-	pF
	Input-Output Isolation Resistance	RIO	RH=40~60%, V=500V	-	10 ¹¹	-	Ω
	Rise Time	tr	VCE=5V, RL=100 Ω	-	4	-	μ s
	Fall Time	tf	IC=2mA	-	4	-	μ s

*5. CTR=(IC/IF) X 100 (%)

PC-17K1 • PC-17K2 • PC-17K4

Forward Current vs. Ambient Temperature

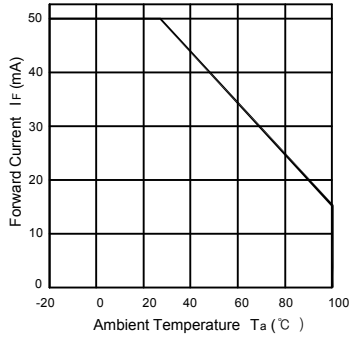

Collector Power Dissipation vs. Ambient Temperature

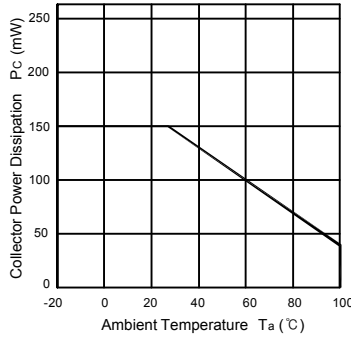

Forward Current vs. Forward Voltage

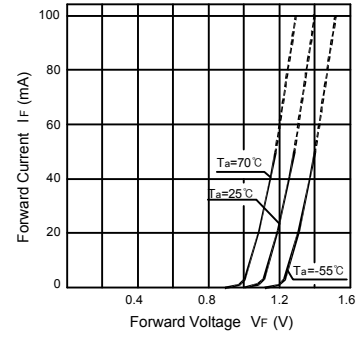

Collector Current vs. Collector-Emitter Voltage

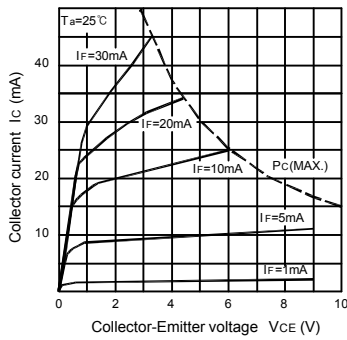

Dark Current vs. Ambient Temperature

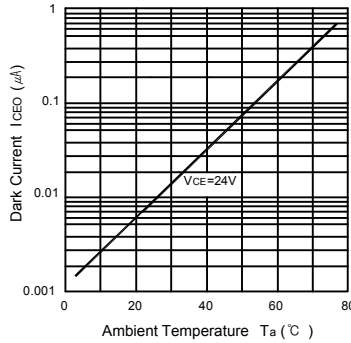

Collector Current vs. Ambient Temperature

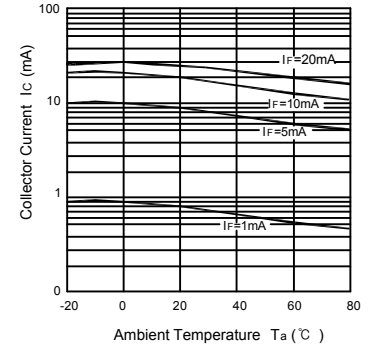

Response Time vs. Load Resistance

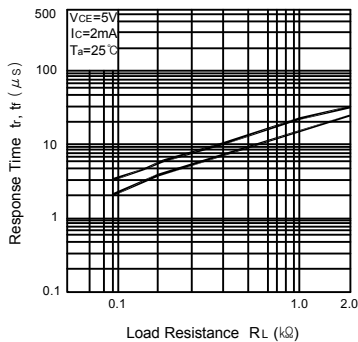

Collector Current vs. Forward Current

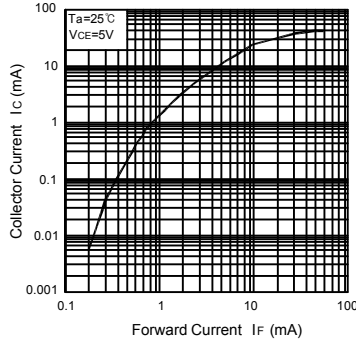

Switching Time Test Circuit

