

REV	DATE	DESCRIPTTON	REVISER
1.0			

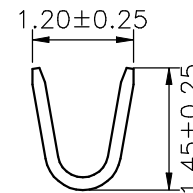

SEC:A-A

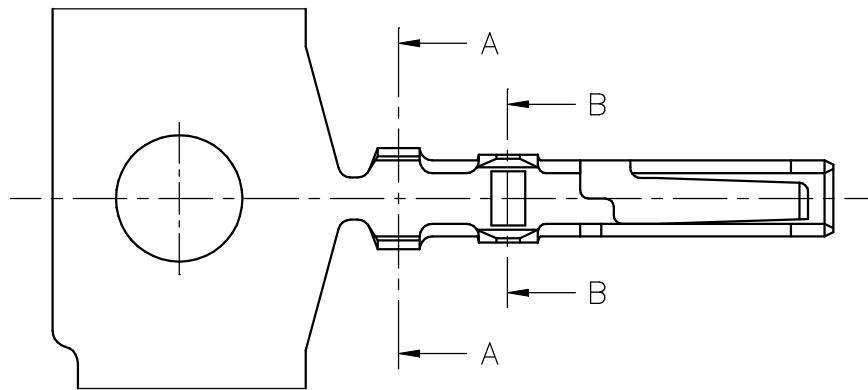
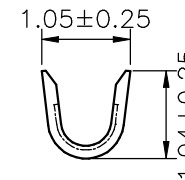
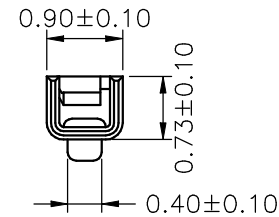
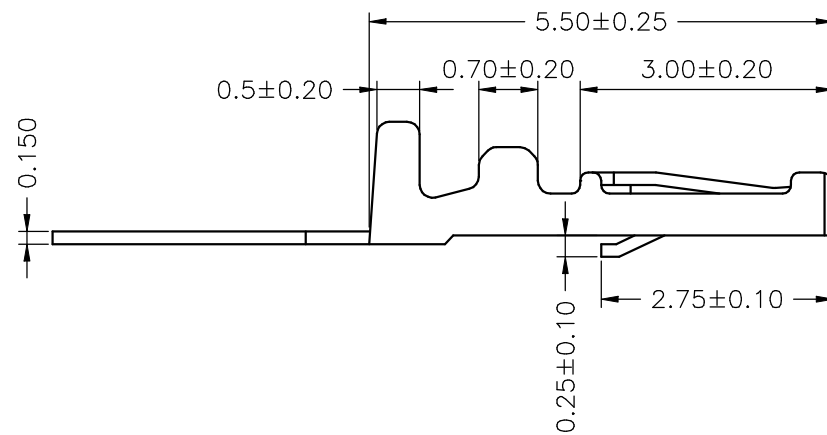

SEC:B-B

CJT® CHANGJIANG CONNECTORS CO., LTD.
 CHANGJIANG CONNECTORS

Ordering information & Specifications

Unit:mm

Part No	Wire Range	Insultion O.D.	Material	Finish	Qty/reel
A1254-GP	AWG# 28-#32	0.90mm(max)	Phosphor Bronze	Gold-flash	10,000 pcs

Note:e-stamping before Tin-plated

Specification

Client:		Drawing No: A1254-T	
Tolerance	Draw By: LIZhiQiang	Date: 2008-05-15	Unit:mm Scale:Enone
X. X ≤ 0.25	Checked: HE.	Date: 2008-05-15	
X. XX ≤ 0.15	Approved:	Date:	
X. XXX ≤ 0.10	Material:	Edition: A	

REV	DATE	DESCRIPTION	REVISOR
1.0			

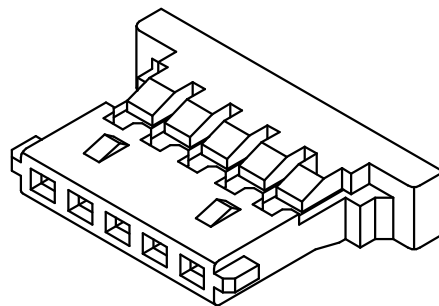
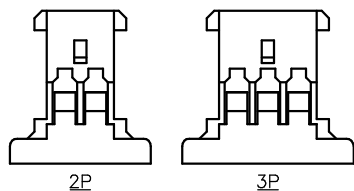

SPECIFICATIONS

Current Rating: 1A AC,DC
Voltage Rating: 125V AC,DC
Temperature Range: -25°C ~ +85°C
Contact Resistance: 20mΩ Max.
Insulation Resistance: 100MΩ Min.
Withstanding Voltage: 500V AC/minute
Material: Nylon 66,UL94V-0
Color: Natural(Beige)

Ordering Information & Dimensions

PART NO.	Dimensions		
	A	B	C
A1254H-2P	1.25	2.72	5.72
A1254H-3P	2.50	3.97	6.97
A1254H-4P	3.75	5.22	8.22
A1254H-5P	5.00	6.47	9.47
A1254H-6P	6.25	7.72	10.72
A1254H-7P	7.50	8.97	11.97
A1254H-8P	8.75	10.22	13.22
A1254H-9P	10.00	11.47	14.47
A1254H-10P	11.25	12.72	15.72
A1254H-11P	12.50	13.97	16.97
A1254H-12P	13.75	15.22	18.22
A1254H-14P	16.25	17.72	20.72
A1254H-15P	17.50	18.97	21.97
A1254H-20P	23.75	25.22	28.22
A1254H-30P	36.25	37.72	40.72

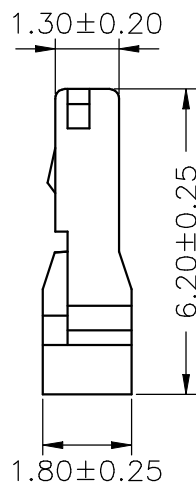
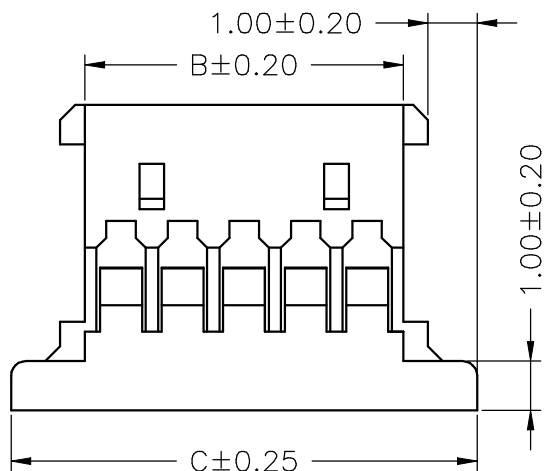
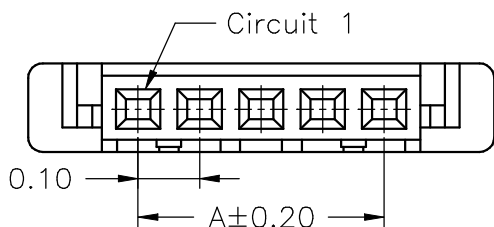

Specification

Client:		Drawing No: A1254H- NP	
Tolerance	Draw By: LIZhiQiang	Date: 2008-05-15	Unit:mm Scale:Enone
X. X ≤ 0.25	Checked: HE.	Date: 2008-05-15	
X. XX ≤ 0.15	Approved:	Date:	
X. XXX ≤ 0.10	Material:	Edition: A	

REV	DATE	DESCRIPTTON	REVISER
1.0			

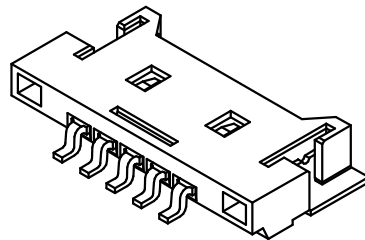
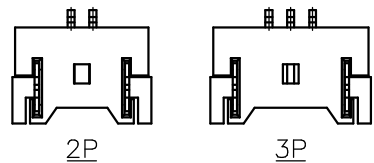

SPECIFICATIONS

Current Rating: 1A AC,DC
Voltage Rating: 125V AC,DC
Temperature Range: -25°C ~ +85°C
Contact Resistance: 20mΩ Max.
Insulation Resistance: 100MΩ Min.
Withstanding Voltage: 500V AC/minute
Pin Material: Brass/Tin-plated on solder area,
Gold-flash on contact area
Solder Tabs: Brass/Tin-plated
Material: Nylon 6T,UL94V-0
Color: Natural(Beige)

Ordering Information & Dimensions

PART NO.	Dimensions		
	A	B	C
A1254WR-S-2P	1.25	7.65	7.97
A1254WR-S-3P	2.50	8.90	9.22
A1254WR-S-4P	3.75	10.15	10.47
A1254WR-S-5P	5.00	11.40	11.72
A1254WR-S-6P	6.25	12.65	12.97
A1254WR-S-7P	7.50	13.90	14.22
A1254WR-S-8P	8.75	15.15	15.47
A1254WR-S-9P	10.00	16.40	16.72
A1254WR-S-10P	11.25	17.65	17.97
A1254WR-S-11P	12.50	18.90	19.22
A1254WR-S-12P	13.75	20.15	20.47
A1254WR-S-14P	16.25	22.65	22.97
A1254WR-S-15P	17.50	23.90	24.22
A1254WR-S-20P	23.75	30.15	30.47
A1254WR-S-30P	36.25	42.65	42.97

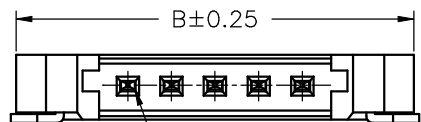
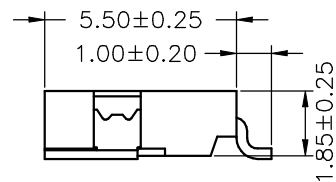
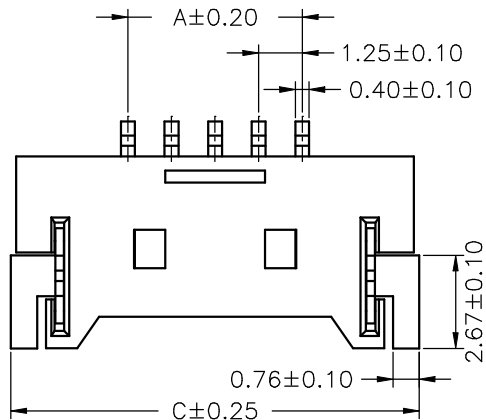
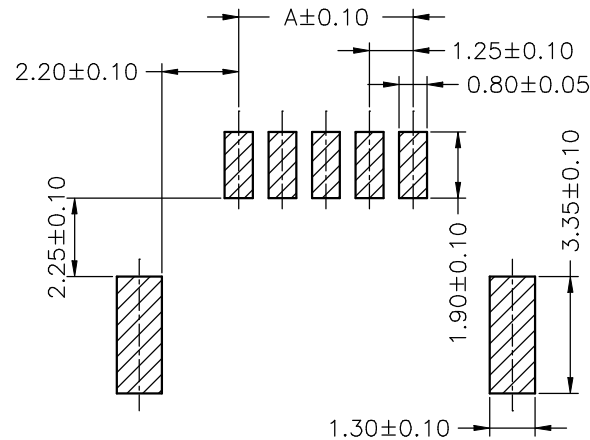

Circuit 1



Specification

Client:		Drawing No: A1254WR-S-NP	
Tolerance	Draw By: LIZhiQiang	Date: 2008-05-15	Unit:mm Scale:Enone
X. X ≤ 0.25	Checked: HE.	Date: 2008-05-15	
X. XX ≤ 0.15	Approved:	Date:	
X. XXX ≤ 0.10	Material:	Edition: A	

REV	DATE	DESCRIPTION	REVISER
1.0			

2~9 Contacts

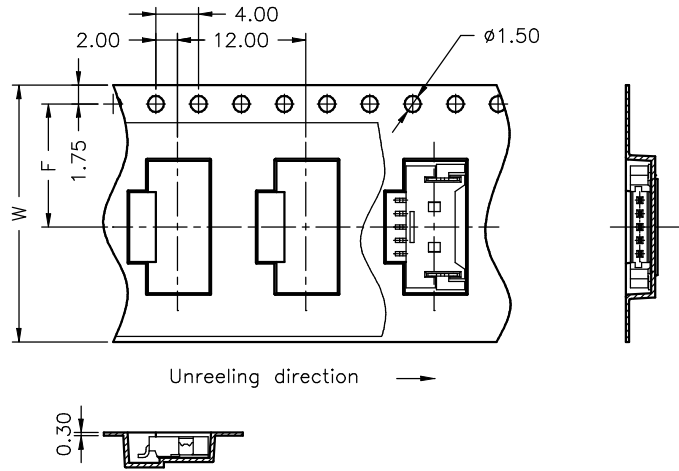

10~30 Contacts

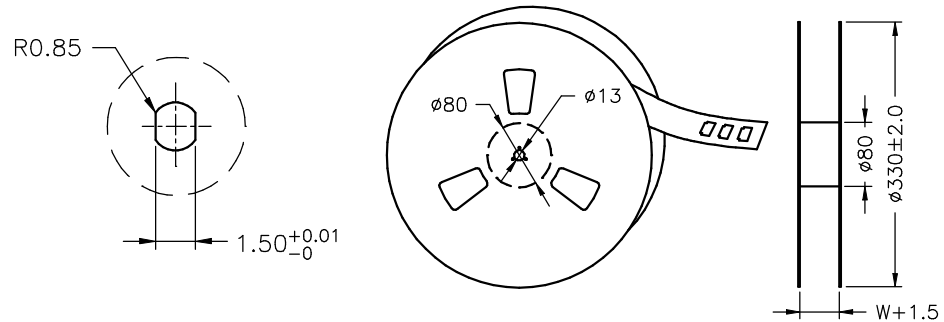
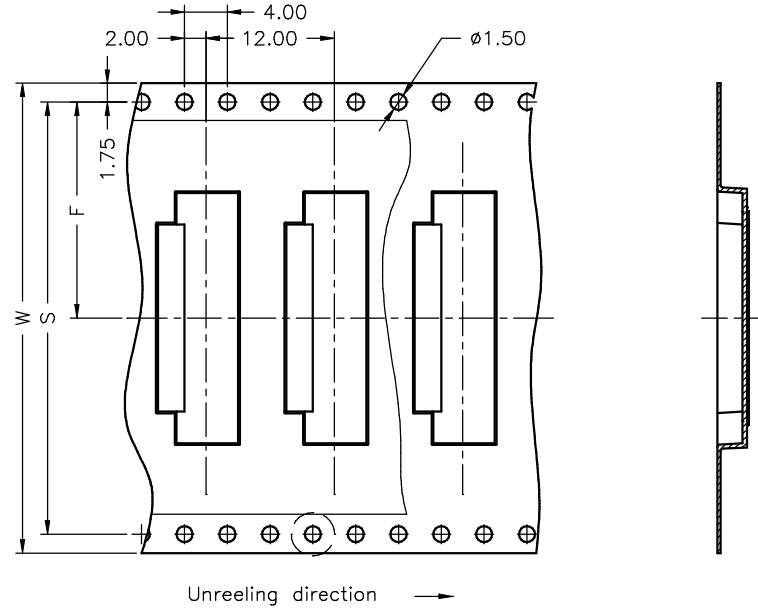

Number of Contacts	W±0.3	F±0.1	S±0.1	Q'ty/Reel
2P	16	7.50		1,000
3P	24	11.50		1,000
4P	24	11.50		1,000
5P	24	11.50		1,000
6P	24	11.50		1,000
7P	24	11.50		1,000
8P	24	11.50		1,000
9P	24	11.50		1,000
10P	32	14.20		28.40
11P	32	14.20	28.40	1,000
12P	32	14.20	28.40	1,000
13P	32	14.20	28.40	1,000
14P	44	20.20	40.40	1,000
15P	44	20.20	40.40	1,000
20P	44	20.20	40.40	1,000
30P	56	26.20	52.40	1,000

CJT® CHANGJIANG CONNECTORS CO., LTD.
CHANGJIANG CONNECTORS

Specification

Client:		Drawing No: A1254WR-S-NP	
Tolerance	Draw By: LIZhiQiang	Date: 2008-05-15	Unit:mm Scale:Enone
X. X ≤ 0.25	Checked: HE.	Date: 2008-05-15	
X. XX ≤ 0.15	Approved:	Date:	
X. XXX ≤ 0.10	Material:	Edition: A	