

Specifications

Current rating:1A AC,DC
Voltage rating:125V AC,DC
Temperature range:-40°C~+105°C
Contact resistance:20mΩMax.
Insulation resistance:100MΩMin.
Withstanding voltage:500V AC/minute
Contact CJT for details

Standards



Assembly layout

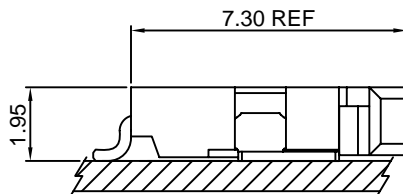

A1254-T

1.25mm pitch Crimp Terminal

Reference Informations:

*Used in CJT A1254 series Housing

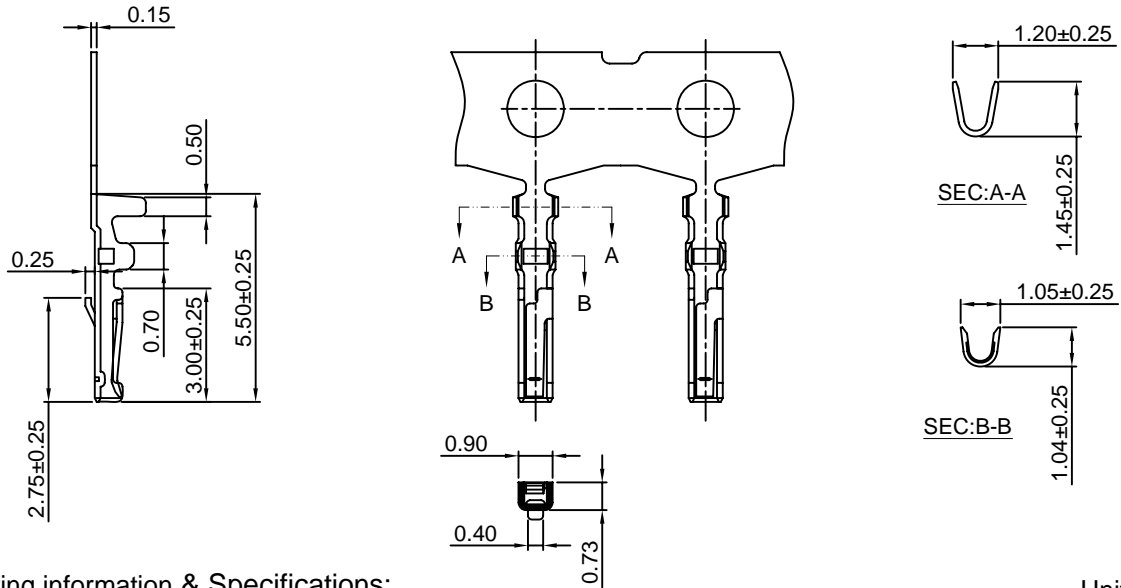

Ordering information & Specifications:

Unit:mm

Part NO.	Wire Range	Insulation O.D.	Material	Finish	Qty/reel
A1254-TP	AWG#28-#32	0.90mm(max)	Phosphor Bronze	Tin over Nickel	10,000 PCS
A1254-GP	AWG#28-#32	0.90mm(max)	Phosphor Bronze	Gold over Nickel	10,000 PCS

Optional Gold plating available but MOQ requested

A1254H

1.25mm pitch Housing

Reference Informations:

*Material:Nylon 66,UL94V-0

*Suitable CJT A1254 series Terminal

*Mates with CJT A1254 series Wafer

*Color:Natural(white)

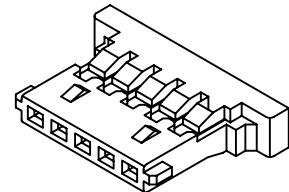

Ordering Information & Dimensions:

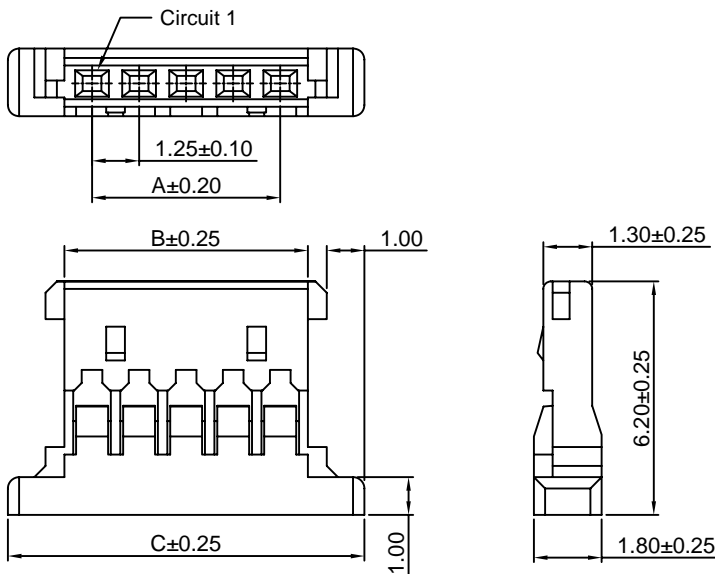

PART NO.	Dimensions		
	A	B	C
A1254H-2P	1.25	2.72	5.72
A1254H-3P	2.50	3.97	6.97
A1254H-4P	3.75	5.22	8.22
A1254H-5P	5.00	6.47	9.47
A1254H-6P	6.25	7.72	10.72
A1254H-7P	7.50	8.97	11.97
A1254H-8P	8.75	10.22	13.22
A1254H-9P	10.00	11.47	14.47
A1254H-10P	11.25	12.72	15.72
A1254H-11P	12.50	13.97	16.97
A1254H-12P	13.75	15.22	18.22
A1254H-13P	15.00	17.72	20.72
A1254H-14P	16.25	18.97	21.97
A1254H-15P	17.50	20.22	23.22
A1254H-20P	23.75	25.22	28.22
A1254H-30P	36.25	37.72	40.72

Unit: mm

A1254HA

1.25mm pitch Housing

Reference Informations:

- *Material:LCP,UL94V-0
- *Suitable CJT A1254 series Terminal
- *Mates with CJT A1254 series Wafer
- *Color:Natural(white)

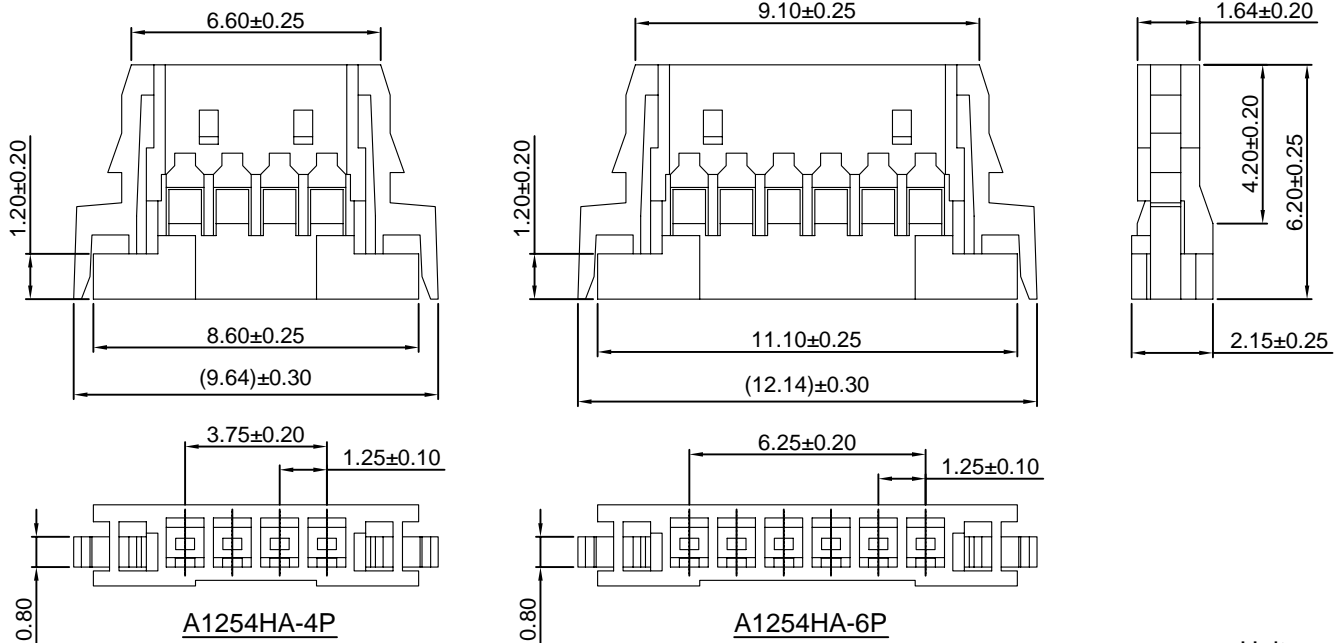
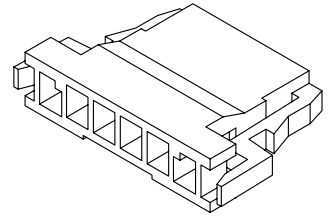

Unit: mm

A1254WR-S

1.25mm pitch 90° Wafer-SMT TYPE

Reference Informations:

- *Material:Pin:Brass/Tin over Nickel on solder area
Gold over Nickel on contact area
- Solder Tabs:Brass/Tin over Nickel
- Insulator:Nylon 6T,UL94V-0
- *Mates with CJT A1254 series Housing
- *Color:Natural(white)

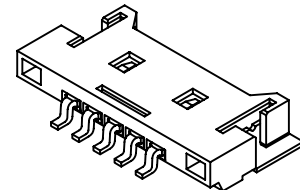

Ordering Information & Dimensions:

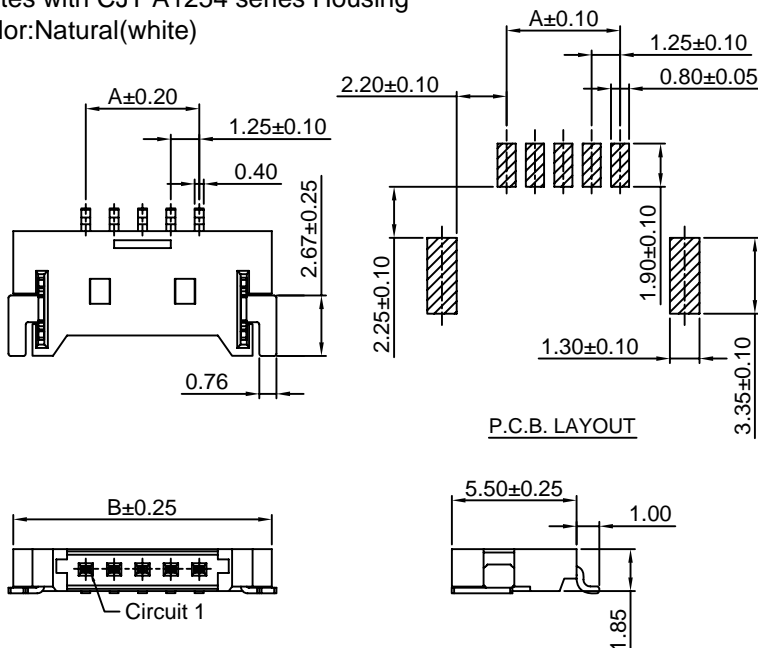

PART NO.	Dimensions	
	A	B
A1254WR-S-2P	1.25	7.65
A1254WR-S-3P	2.50	8.90
A1254WR-S-4P	3.75	10.15
A1254WR-S-5P	5.00	11.40
A1254WR-S-6P	6.25	12.65
A1254WR-S-7P	7.50	13.90
A1254WR-S-8P	8.75	15.15
A1254WR-S-9P	10.00	16.40
A1254WR-S-10P	11.25	17.65
A1254WR-S-11P	12.50	18.90
A1254WR-S-12P	13.75	20.15
A1254WR-S-13P	15.00	22.65
A1254WR-S-14P	16.25	23.90
A1254WR-S-15P	17.50	20.55
A1254WR-S-20P	23.75	30.15
A1254WR-S-30P	36.25	42.65

Unit: mm