

## HEXFRED™

# HFA08TB60PbF

## Ultrafast, Soft Recovery Diode

### Features

- Ultrafast Recovery
- Ultrasoft Recovery
- Very LOW  $I_{RRM}$
- Very Low  $Q_{rr}$
- Specified at Operating Conditions
- Lead-Free

### Benefits

- Reduced RFI and EMI
- Reduced Power Loss in Diode and Switching Transistor
- Higher Frequency Operation
- Reduced Snubbing
- Reduced Parts Count

### Description

International Rectifier's HFA08TB60 is a state of the art ultra fast recovery diode. Employing the latest in epitaxial construction and advanced processing techniques it features a superb combination of characteristics which result in performance which is unsurpassed by any rectifier previously available. With basic ratings of 600 volts and 8 amps continuous current, the HFA08TB60 is especially well suited for use as the companion diode for IGBTs and MOSFETs. In addition to ultra fast recovery time, the HEXFRED product line features extremely low values of peak recovery current ( $I_{RRM}$ ) and does not exhibit any tendency to "snap-off" during the  $t_b$  portion of recovery. The HEXFRED features combine to offer designers a rectifier with lower noise and significantly lower switching losses in both the diode and the switching transistor. These HEXFRED advantages can help to significantly reduce snubbing, component count and heatsink sizes. The HEXFRED HFA08TB60 is ideally suited for applications in power supplies and power conversion systems (such as inverters), motor drives, and many other similar applications where high speed, high efficiency is needed.

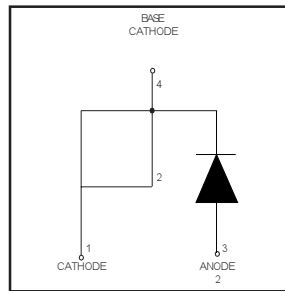

$V_R = 600V$
$V_F(\text{typ.})^* = 1.4V$
$I_{F(AV)} = 8.0A$
$Q_{rr}(\text{typ.}) = 65nC$
$I_{RRM} = 5.0A$
$t_{rr}(\text{typ.}) = 18ns$
$di_{(rec)M}/dt(\text{typ.}) = 240A/\mu s$

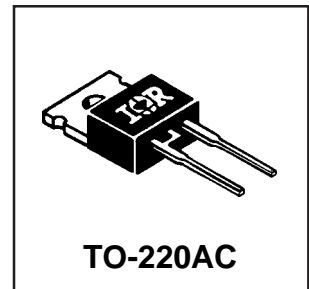

### Absolute Maximum Ratings

	Parameter	Max	Units
$V_R$	Cathode-to-Anode Voltage	600	V
$I_F @ T_C = 100^\circ C$	Continuous Forward Current	8.0	A
$I_{FSM}$	Single Pulse Forward Current	60	
$I_{FRM}$	Maximum Repetitive Forward Current	24	
$P_D @ T_C = 25^\circ C$	Maximum Power Dissipation	36	W
$P_D @ T_C = 100^\circ C$	Maximum Power Dissipation	14	
$T_J$ $T_{STG}$	Operating Junction and Storage Temperature Range	- 55 to +150	C

\* 125°C

**Electrical Characteristics @ T<sub>J</sub> = 25°C (unless otherwise specified)**

	Parameter	Min	Typ	Max	Units	Test Conditions
V <sub>BR</sub>	Cathode Anode Breakdown Voltage	600			V	I <sub>R</sub> = 100μA
V <sub>FM</sub>	Max Forward Voltage		1.4	1.7	V	I <sub>F</sub> = 8.0A
			1.7	2.1		I <sub>F</sub> = 16A
			1.4	1.7		I <sub>F</sub> = 8.0A, T <sub>J</sub> = 125°C
I <sub>RM</sub>	Max Reverse Leakage Current		0.3	5.0	μA	V <sub>R</sub> = V <sub>R</sub> Rated
			100	500		T <sub>J</sub> = 125°C, V <sub>R</sub> = 0.8 x V <sub>R</sub> Rated
C <sub>T</sub>	Junction Capacitance		10	25	pF	V <sub>R</sub> = 200V
L <sub>S</sub>	Series Inductance		8.0		nH	Measured lead to lead 5mm from package body

**Dynamic Recovery Characteristics @ T<sub>J</sub> = 25°C (unless otherwise specified)**

	Parameter	Min	Typ	Max	Units	Test Conditions
t <sub>rr</sub>	Reverse Recovery Time		18		ns	I <sub>F</sub> = 1.0A, di <sub>F</sub> /dt = 200A/μs, V <sub>R</sub> = 30V
t <sub>rr1</sub>	See Fig. 5, 6 & 16		37	55		T <sub>J</sub> = 25°C
t <sub>rr2</sub>			55	90		T <sub>J</sub> = 125°C
I <sub>RRM1</sub>	Peak Recovery Current See Fig. 7 & 8		3.5	5.0	A	T <sub>J</sub> = 25°C
I <sub>RRM2</sub>			4.5	8.0		T <sub>J</sub> = 125°C
Q <sub>rr1</sub>	Reverse Recovery Charge See Fig. 9 & 10		65	138	nC	T <sub>J</sub> = 25°C
Q <sub>rr2</sub>			124	360		T <sub>J</sub> = 125°C
di <sub>(rec)M</sub> /dt1	Peak Rate of Fall of Recovery Current		240		A/μs	T <sub>J</sub> = 25°C
di <sub>(rec)M</sub> /dt2	During t <sub>b</sub> See Fig. 11 & 12		210			T <sub>J</sub> = 125°C

**Thermal - Mechanical Characteristics**

	Parameter	Min	Typ	Max	Units
T <sub>lead</sub> ①	Lead Temperature			300	°C
R <sub>thJC</sub>	Thermal Resistance, Junction to Case			3.5	K/W
R <sub>thJA</sub> ②	Thermal Resistance, Junction to Ambient			80	
R <sub>thCS</sub> ③	Thermal Resistance, Case to Heat Sink		0.5		
Wt	Weight		2.0		g
			0.07		(oz)
	Mounting Torque	6.0		12	Kg-cm
		5.0		10	lbf•in

① 0.063 in. from Case (1.6mm) for 10 sec

② Typical Socket Mount

③ Mounting Surface, Flat, Smooth and Greased

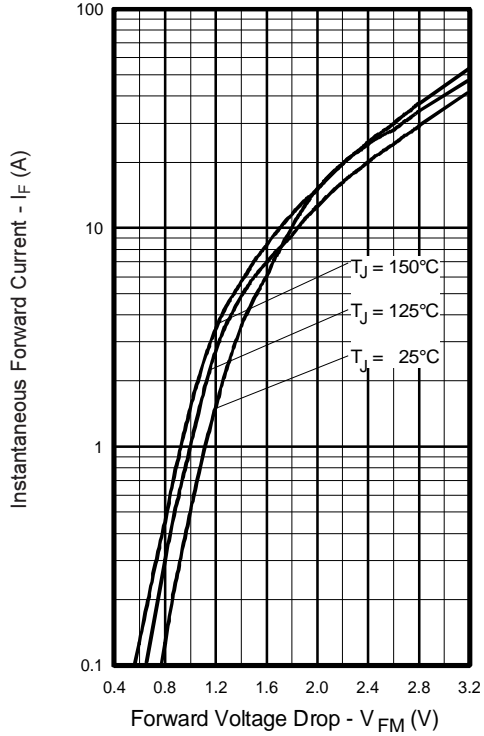

**Fig. 1** - Maximum Forward Voltage Drop vs. Instantaneous Forward Current

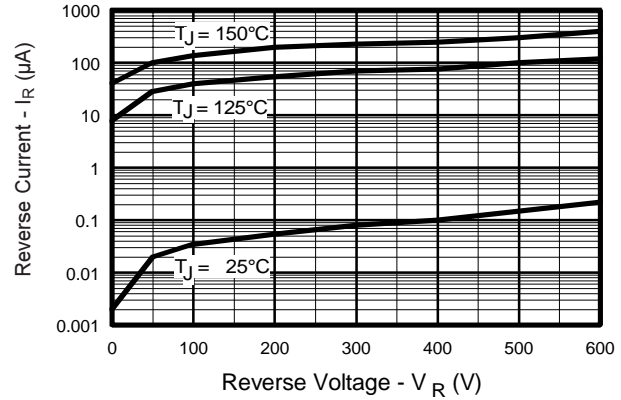

**Fig. 2** - Typical Reverse Current vs. Reverse Voltage

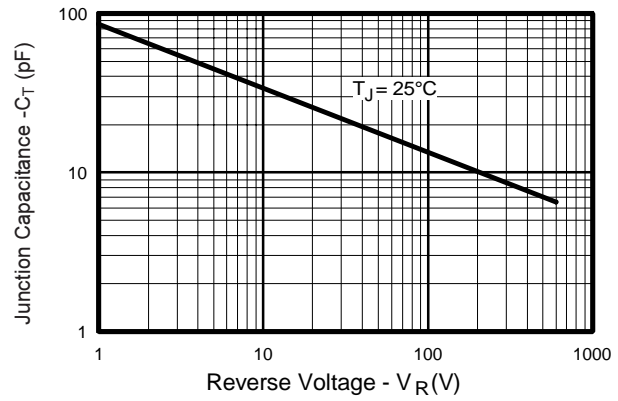

**Fig. 3** - Typical Junction Capacitance vs. Reverse Voltage

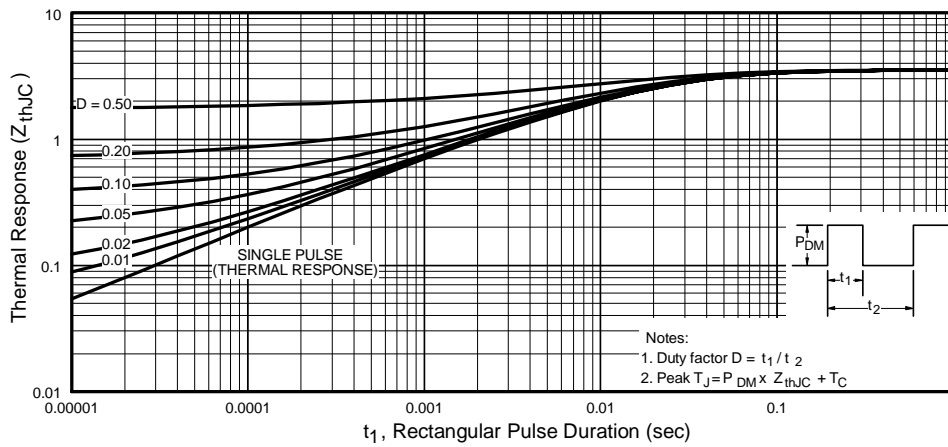

**Fig. 4** - Maximum Thermal Impedance  $Z_{thJC}$  Characteristics

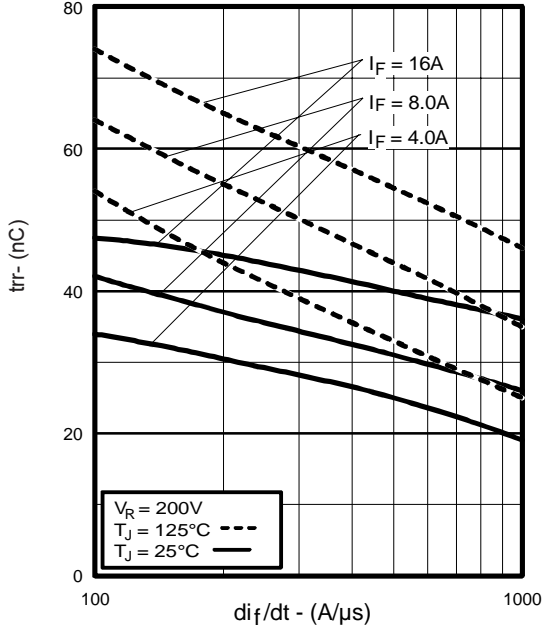

Fig. 5 - Typical Reverse Recovery vs.  $di_f/dt$

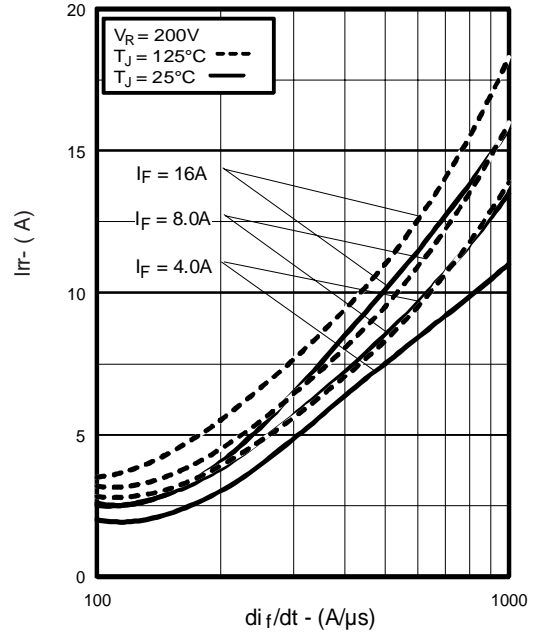

Fig. 6 - Typical Recovery Current vs.  $di_f/dt$

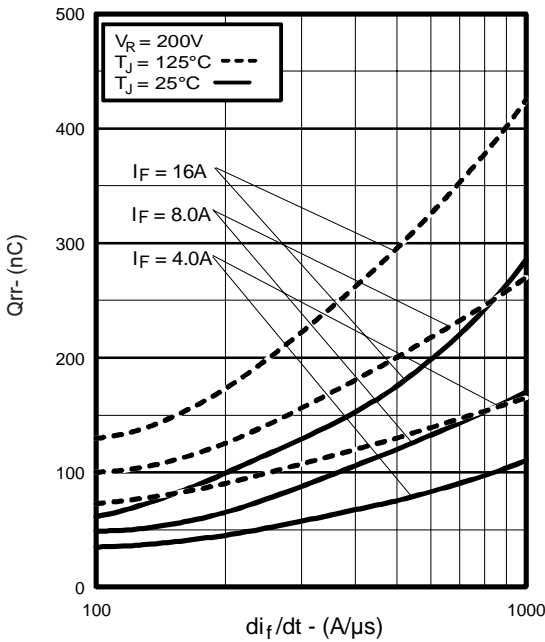

Fig. 7 - Typical Stored Charge vs.  $di_f/dt$

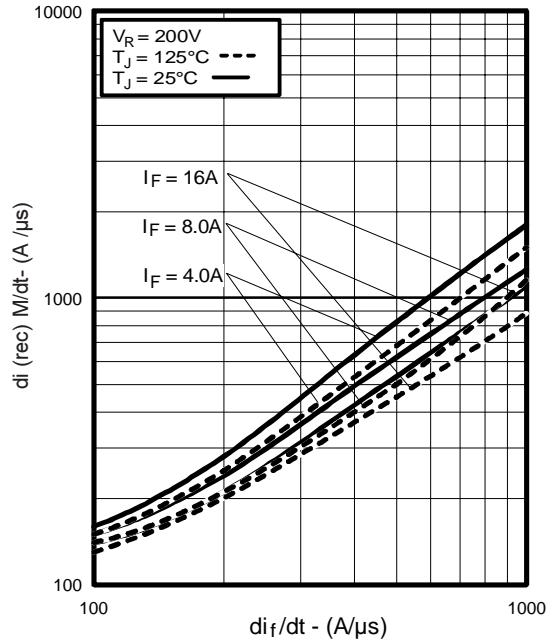
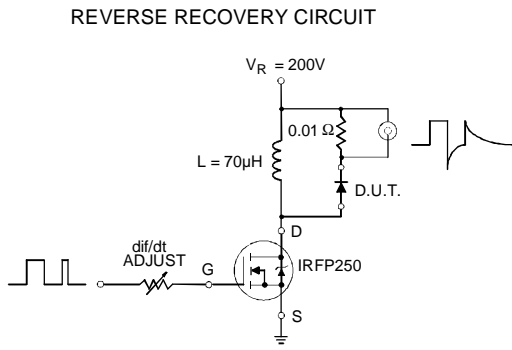
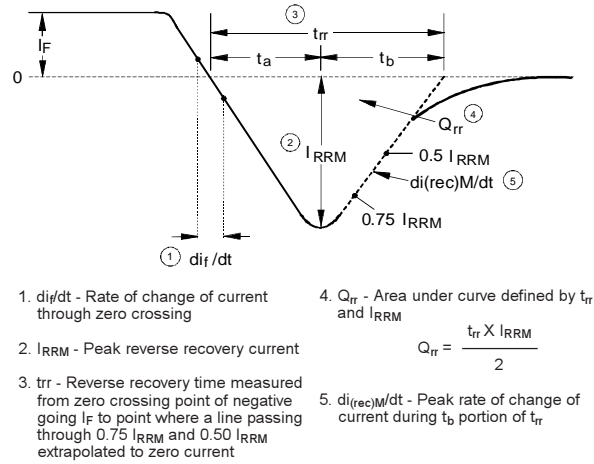

Fig. 8 - Typical  $di_{(rec)M}/dt$  vs.  $di_f/dt$



**Fig. 9 - Reverse Recovery Parameter Test Circuit**



**Fig. 10 - Reverse Recovery Waveform and Definitions**

HFA08TB60PbF

International  
**IOR** Rectifier

### TO-220AC Package Outline

Dimensions are shown in millimeters (inches)

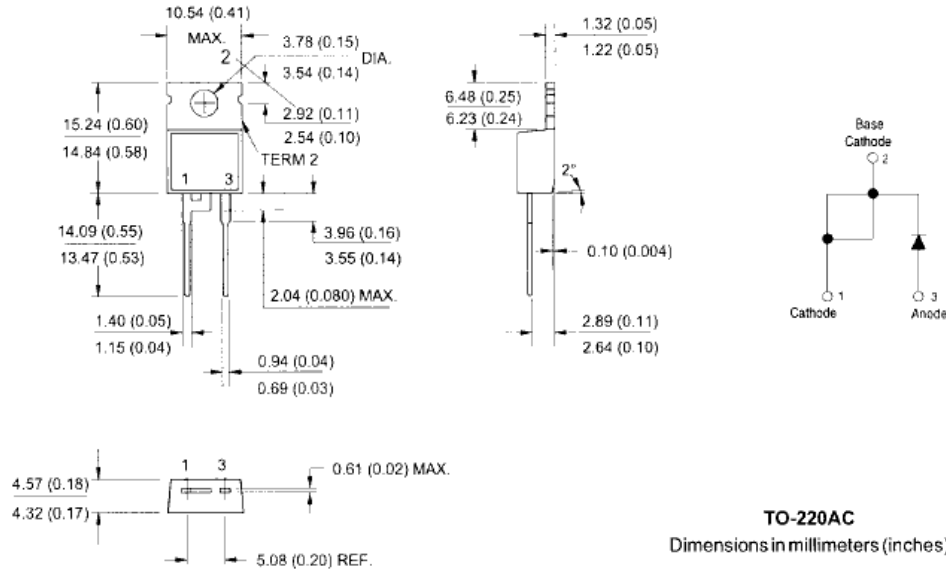

### TO-220AC Part Marking Information

EXAMPLE: THIS IS A HFA06TB120  
LOT CODE 1789  
ASSEMBLED ON WW19, 2001  
IN THE ASSEMBLY LINE "C"

Note: "P" in the beginning of date code indicates "Lead-Free"

OR

EXAMPLE: THIS IS A HFA06TB120  
LOT CODE 1789  
ASSEMBLED ON WW19, 2001  
IN THE ASSEMBLY LINE "C"

Note: "P" in assembly line position indicates "Lead-Free"

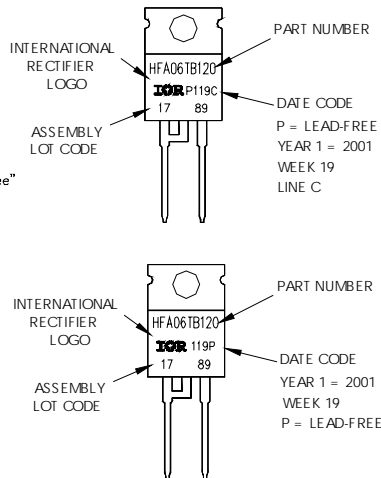

Data and specifications subject to change without notice.

International  
**IOR** Rectifier

IR WORLD HEADQUARTERS: 233 Kansas St., El Segundo, California 90245, USA Tel: (310) 252-7105  
TAC Fax: (310) 252-7903

Visit us at [www.irf.com](http://www.irf.com) for sales contact information. 10/04