



Series MR

Half-Inch Diameter Rotary Switches

TYPICAL SWITCH ORDERING EXAMPLE



ACTUATORS & TERMINALS	
A	Shaft Actuated with PC Terminals
F	Low Profile Screwdriver Actuated with PC Terminals
K	Low Profile Shaft Actuated with PC Terminals

POLES & CIRCUITS	
112	SP with 2-12 Positions
206	DP with 2-6 Positions
403	4P with 2-3 Positions

DESCRIPTION FOR TYPICAL ORDERING EXAMPLE

MRA206-A

KNOBS	
A	Plain Black
B	Small Color Tipped
C	Large Color Tipped

COLORS	
For Plain Knob	
No Code	Black
For Color Tipped	
A	Black
B	White
C	Red
E	Yellow
F	Green
G	Blue
H	Gray

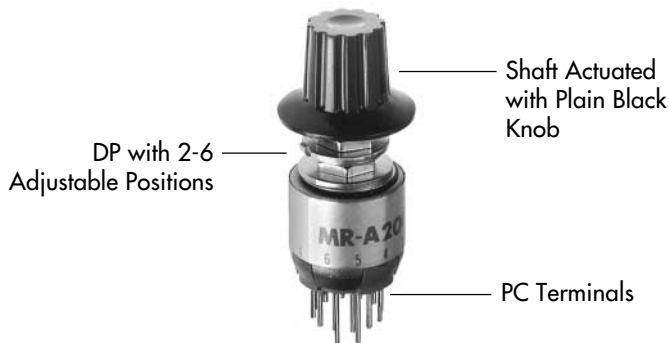

- General Specifications
- Dimensions

ACTUATORS & TERMINALS

A Shaft Actuated with PC Terminals

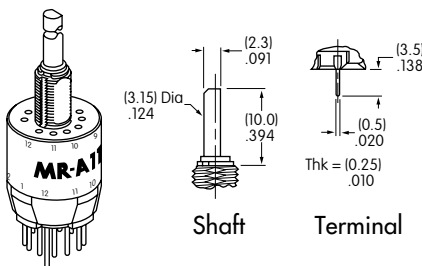

F Low Profile Screwdriver Actuated w/PC Terminals

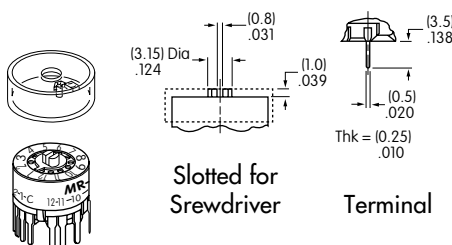

K Low Profile Shaft Actuated w/PC Terminals

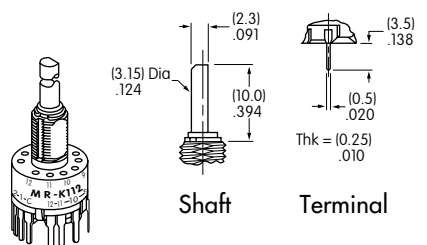



GENERAL SPECIFICATIONS

Electrical Capacity (Resistive Load)

For MRA: 250mA @ 125V AC or 48V DC
For MRF & MRK: 0.4VA maximum @ 28V AC/DC maximum
(Applicable Range 0.1mA ~ 0.1A @ 20mV ~ 28V)

Note: See [Supplement Index](#) to find explanation of operating range.

Other Ratings

Contact Resistance: 10 milliohms maximum for MRA; 50 milliohms maximum for MRF & MRK
Insulation Resistance: 100 megohms minimum @ 500V DC
Dielectric Strength: 1,000V AC minimum for MRA; 500V AC minimum for MRF & MRK
Mechanical Life: 30,000 operations minimum
Electrical Life: 10,000 operations minimum
Range of Operating Torque: 250 ~ 750 grams-cm for MRA; 50 ~ 250 grams-cm for MRF & MRK
Contact Timing: Nonshorting (break-before-make)
MRA ~ self-cleaning, sliding contact; MRF & MRK ~ Self-cleaning, rotary contactor disk
Indexing: 30°

Materials & Finishes

Shaft: Brass with nickel plating
Stopper Plate: Steel with zinc plating for MRA & MRK
Polyamide cover with stopper for MRF
Bushing/Housing: Zinc alloy with zinc plating
Movable Contacts: Copper with silver plating for MRA
Phosphor bronze with gold plating for MRF & MRK
End Contacts & Terminals: Brass with silver plating for MRA
Phosphor bronze with gold plating for MRF & MRK
Common Contacts & Terminals: Brass with silver plating for MRA
Phosphor bronze with gold plating for MRF & MRK
Base: Diallyl phthalate for MRA; fiberglass reinforced polyamide for MRF & MRK

Environmental Data

Operating Temp Range: -10°C through +70°C (+14°F through +158°F)
Humidity: 90 ~ 95% humidity for 96 hours @ 40°C (104°F)
Vibration: 10 ~ 55Hz with peak-to-peak amplitude of 1.5mm traversing the frequency range & returning in 1 minute; 3 right angled directions for 2 hours
Shock: 50g acceleration (tested in 3 right angled directions, with 3 shocks in each direction)

Installation

Mounting Torque: 2 ~ 3 kgf/cm (1.74 ~ 2.60 lb/in) for MRA & MRK
Soldering Time & Temperature: 3 seconds @ 350°C or 5 seconds @ 270°C
Process Seal: See [Supplement Index](#) for specific processing data applicable to MRA, MRF, & MRK models.



Series MR

Half-Inch Diameter Rotary Switches

POLES & CIRCUITS

Pole	Model	Number of Positions	Stopper Settings	Number of Terminals	Schematics
SP	MRA112	2-12	2, 3, 4, . . . 12	1 COM, 12 LOAD	
	MRF112	2-12	2, 3, 4, . . . 12	1 COM, 12 LOAD	
	MRK112	2-12	2, 3, 4, . . . 12	1 COM, 12 LOAD	
DP	MRA206	2-6	2, 3, 4, 5, 6	2 COM, 12 LOAD	
	MRF206	2-6	2, 3, 4, 5, 6	2 COM, 12 LOAD	
	MRK206	2-6	2, 3, 4, 5, 6	2 COM, 12 LOAD	
4P	MRA403	2-3	2, 3	4 COM, 12 LOAD	
	MRF403	2-3	2, 3	4 COM, 12 LOAD	
	MRK403	2-3	2, 3	4 COM, 12 LOAD	

POSITION SETTING FOR MRA, MRF, & MRK MODELS

Each switch is supplied with the stopper set for the maximum number of positions allowed for that model. Prior to installation, the desired position setting should be made.

MRF Models:

1. Remove the protective cover from the switch body.
2. Turn the shaft counterclockwise to the extreme left by using a screwdriver.
3. Inside the cover is a magnifying lens which should be positioned over the number which is to be the maximum position used; when the cover is then snapped onto the switch, the projection beside the lens fits into the correct hole for setting the stop.

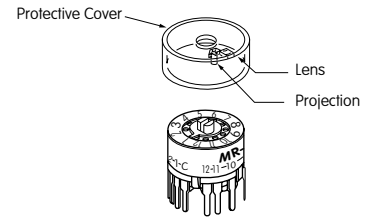

MRK and MRA Models:

1. Using the actuator knob, turn the shaft counterclockwise to the extreme left. If the shaft is not turned counterclockwise to the extreme left, proper setting cannot be achieved. At this extreme position, the white line on the knob points to the number 1 position shown on the side of the switch.
2. Remove the knob from the shaft and loosen the nut far enough to allow raising the stopper plate for resetting to the desired position.
3. Note the position numbers on the side of the switch; these correspond to the terminal numbers and stopper holes. Insert the stopper in the hole numbered for the maximum desired number of stop settings. Satisfactory switch functioning cannot be assured if the stopper plate is not properly positioned.
4. Tighten the nut (beveled side up) firmly against the stopper plate.

Standard Mounting Hardware Packaged Loose with Each Switch:

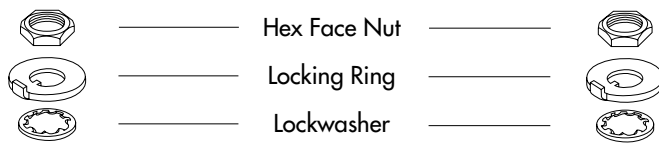

Rubber Ring (MRK)

Factory Assembled:

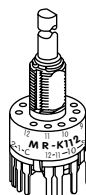
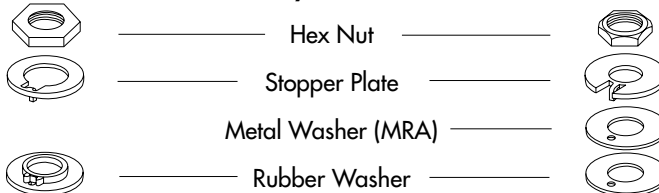



Series MR

Half-Inch Diameter Rotary Switches

TYPICAL SWITCH DIMENSIONS

MRA • PC Terminals

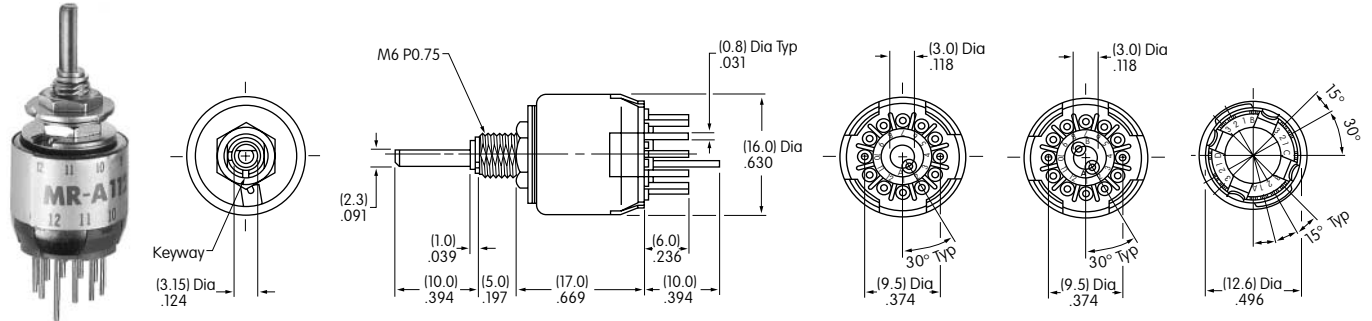

MRA112

MRF • PC Terminals

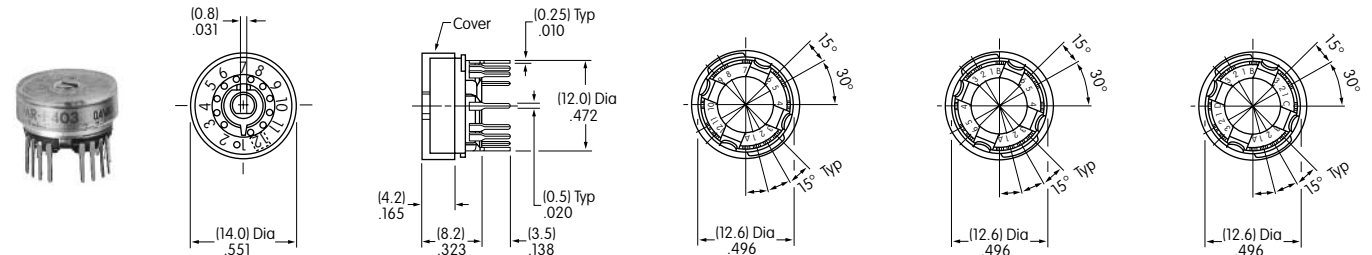

MRF112

MRK • PC Terminals

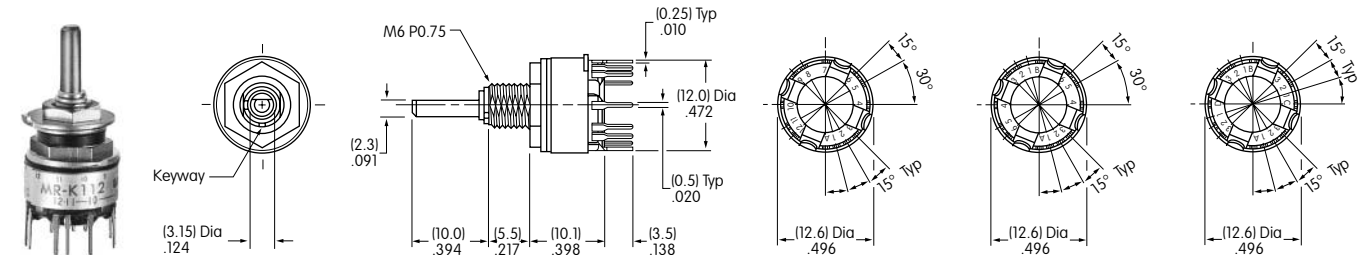

MRK112

MRK devices are designed to be panel mounted. Installation without panel mounting will affect reliability.

FOOTPRINTS

Single Pole
MRA112

Double Pole
MRA206

Four Pole
MRA403

Single Pole
MRF112
MRK112

Double Pole
MRF206
MRK206

Four Pole
MRF403
MRK403

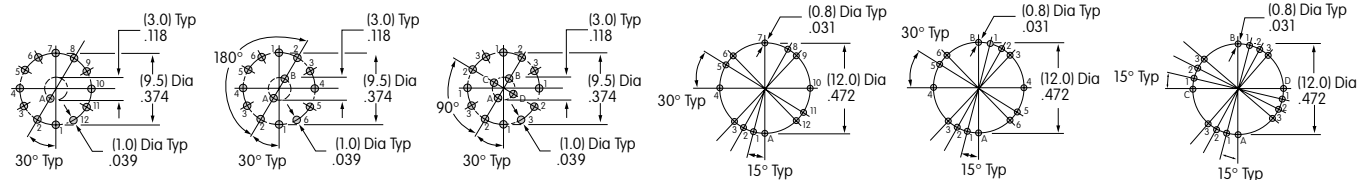



Series MR

Half-Inch Diameter Rotary Switches

KNOBS

A AT433 Plain Black

Material:
Polyacetal

Color:
Black only

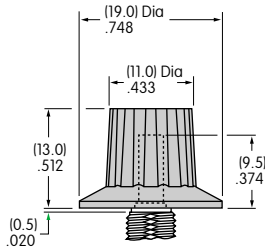

B AT4103 Small Color Tipped

Base Material:
Polyester
Base Color:
Black

Polyamide
Tip Colors:
A, B, C, E,
F, G, H

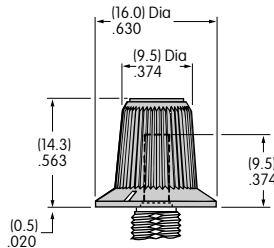

C AT4104 Large Color Tipped

Base Material:
Polyester
Base Color:
Black

Polyamide
Tip Colors:
A, B, C, E,
F, G, H

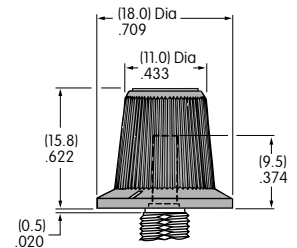

Color Codes: **A** Black **B** White **C** Red **E** Yellow **F** Green **G** Blue **H** Gray

PANEL CUTOUTS & MAXIMUM EFFECTIVE PANEL THICKNESS

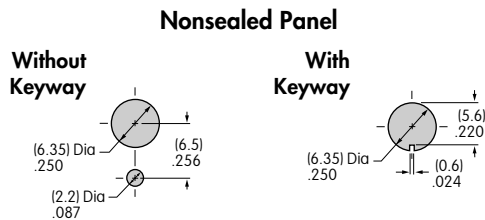

Sealed Panel

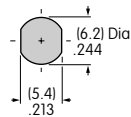

With Standard Hardware on Nonsealed Panel:
MRA 1.7mm (.067") MRK 2.2mm (.087")

Without Locking Ring on Nonsealed Panel:
MRA 2.5mm (.098") MRK 3.0mm (.118")

With Standard Hardware on Sealed Panel:
MRK 2.7mm (.106")

STANDARD MOUNTING HARDWARE

AT513M Metric Hexagon Nut

Material:
Brass, nickel plated

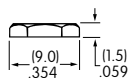
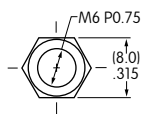

1 for MRA; 1 for MRK

AT507M Metric Locking Ring

Material:
Steel, chromate over zinc plating

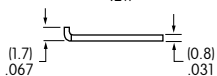
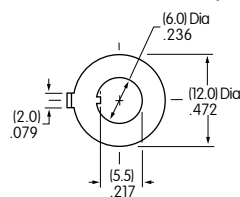

1 for MRA; 1 for MRK

AT509 Lockwasher

Material:
Steel, chromate over zinc plating

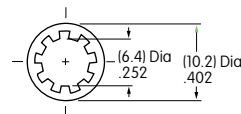

1 for MRA; 1 for MRK

AT535 Rubber Ring

Material:
Nitrile butadiene rubber

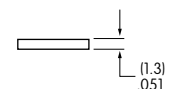
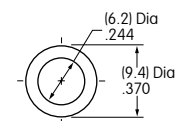

1 for MRK

OPTIONAL SUPPORT BRACKET

AT543 Support Bracket for MRK

Material: Steel with Tin Plating

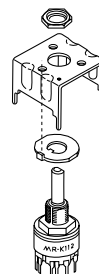
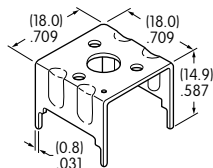

A support bracket is needed when the MRK is mounted only to a PC board and does not have the bushing through a panel.