

Ultra Low Ohm (Metal Strip) Chip Resistor—LR Series 超合金貼片電阻

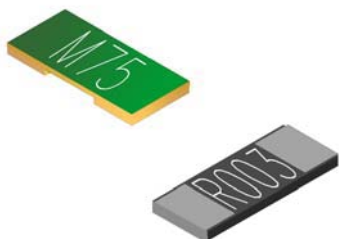

Features

- High Wattage Rating Up to 3W
- Low TCR $\pm 50, \pm 100$ PPM/°C
- Resistance Values from 0.5 to 20 m ohms
- Without Laser Trimmed with Very Low Inductance
- Customized Resistance Available

Applications

- NB (for Power Management)
- MB (for Power Management)
- SWPS (DC-DC Converter, Charger, Adaptor)
- Monitor (for Power Management)

Construction

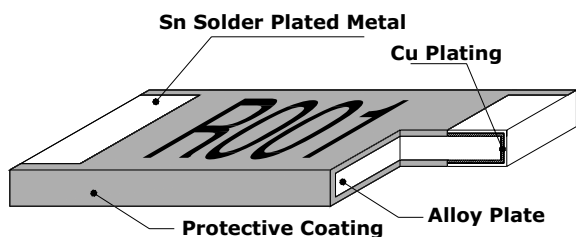
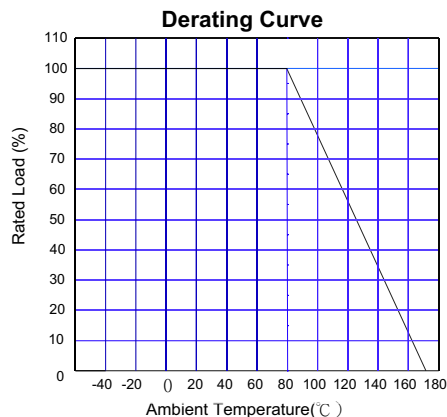

Figure 1

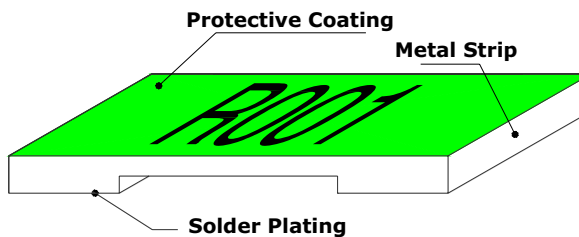
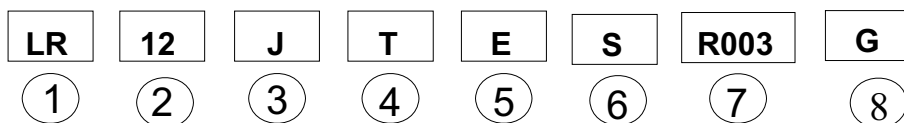

Figure 2

Part Numbering Product Type



① Product Type

Product Type	Type
LR	Ultra Low Ohm Metal Strip Chip Resistor

② Dimensions (L×W)

Codes	Dimensions (L×W)	EIA
LR12	6.3×3.1mm	2512

③ Resistance Tolerance

Codes	Resistance Tolerance
J	$\pm 5\%$
H	$\pm 3\%$
G	$\pm 2\%$
F	$\pm 1\%$

④ Packaging

Code	Type
T	Taping Reel

⑤ TCR

Codes	Type
D	± 50 PPM/°C
W	± 75 PPM/°C
E	± 100 PPM/°C
K	± 150 PPM/°C

⑥ Power Rating

Codes	Type
	Standard (1W)
S	(2W)
R	(3W)
B	(2.5W)

⑦ Resistance

Codes	Type
0M50	0.00050Ω
0M75	0.00075Ω
1M50	0.00150Ω
R002	0.00200Ω
R020	0.02000Ω

⑧ Protective Coating

Codes	Type
	Black Coating
G	Green Coating

Dimensions

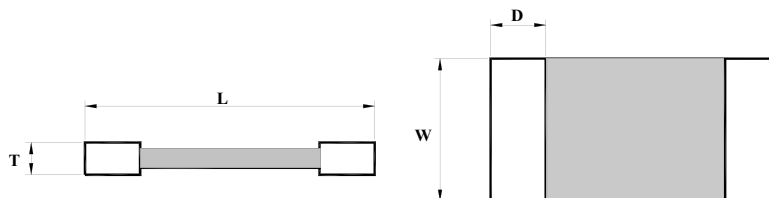

Unit: mm

Part No.	Resistance(m Ω)	L	W	T	D
LR12□T□□□□□G	0.50~0.75	6.35±0.25	3.18±0.35	1.00±0.20	1.93±0.75
LR12□T□□□□□G	1.0~20	6.35±0.25	3.18±0.35	0.60±0.20	1.93±0.75
LR12□T□0M50	0.50	6.35±0.25	3.18±0.25	1.40±0.20	1.30±0.30
LR12□T□0M75	0.75	6.35±0.25	3.18±0.25	1.00±0.20	1.30±0.30
LR12□T□R001	1.00	6.35±0.25	3.18±0.25	0.80±0.20	1.30±0.30
LR12□T□1M50	1.50	6.35±0.25	3.18±0.25	0.65±0.20	1.30±0.30
LR12□T□R002	2.00	6.35±0.25	3.18±0.25	0.50±0.20	1.30±0.30
LR12□T□2M50	2.50	6.35±0.25	3.18±0.25	1.00±0.20	1.30±0.30
LR12□T□R003	3.00	6.35±0.25	3.18±0.25	0.70±0.20	1.30±0.30
LR12□T□3M50	3.50	6.35±0.25	3.18±0.25	0.71±0.20	1.30±0.30
LR12□T□R004	4.00	6.35±0.25	3.18±0.25	0.60±0.20	1.30±0.30
LR12□T□4M50	4.50	6.35±0.25	3.18±0.25	0.58±0.20	1.30±0.30
LR12□T□R005	5.00	6.35±0.25	3.18±0.25	0.50±0.20	1.30±0.30
LR12□T□5M50	5.50	6.35±0.25	3.18±0.25	0.47±0.20	1.30±0.30
LR12□T□R006	6.00	6.35±0.25	3.18±0.25	0.50±0.20	1.30±0.30
LR12□T□6M50	6.50	6.35±0.25	3.18±0.25	0.47±0.20	1.30±0.30
LR12□T□R007	7.00	6.35±0.25	3.18±0.25	0.45±0.20	1.30±0.30
LR12□T□R010	10.0	6.50±0.35	3.20±0.25	0.80±0.15	1.90±0.15

Standard Electrical Specifications

Type	Item	Power Rating at 80°C	Operating Temp. Range	Resistance Tolerance (±%)	Resistance (mΩ)	TCR (PPM/°C)
LR12□TD□□□□□		1W	-55°C ~ +170°C	1,3,5	0.5~2.0	50
LR12□TK□□□□□		1W		1,3,5	2.5~3.0	150
LR12□TE□□□□□		1W		1,3,5	4.0~5.5	100
LR12□TW□□□□□		1W		1,3,5	6.0~7.0	75
LR12□TER010		1W		1,3,5	10	100
LR12□TD□□□□□G		1W		1,3,5	11~20	50

Operating Current $I = \sqrt{P/R}$; Operating Voltage $V = \sqrt{P \cdot R}$

High Power Rating Electrical Specifications

Type	Item	Power Rating at 80°C	Operating Temp. Range	Resistance Tolerance (±%)	Resistance (mΩ)	TCR (PPM/°C)
LR12□TDS□□□□□		2.0W	-55°C ~ +170°C	1,3,5	0.5~2.0	50
LR12□TDS□□□□□G		2.0W		1,3,5	7.0~10.0	50
LR12□TDB□□□□□G		2.5W		1,3,5	4.0~6.0	50
LR12□TWRR003G		3.0W		1,3,5	3.0	75
LR12□TDR□□□□□G		3.0W		1,3,5	1.0~2.0	50
LR12□TER□□□□□G		3.0W		1,3,5	0.5~0.75	100

Operating Current $I = \sqrt{P/R}$; Operating Voltage $V = \sqrt{P \cdot R}$

* Mayloon is capable of manufacturing the optional spec based on customer's requirement.

Packaging

Packaging Quantity

Unit: EA

Packaging	Emboss Plastic Tape
Series LR12	2,000

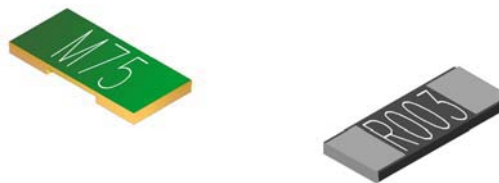

Emboss Plastic Tape Specifications

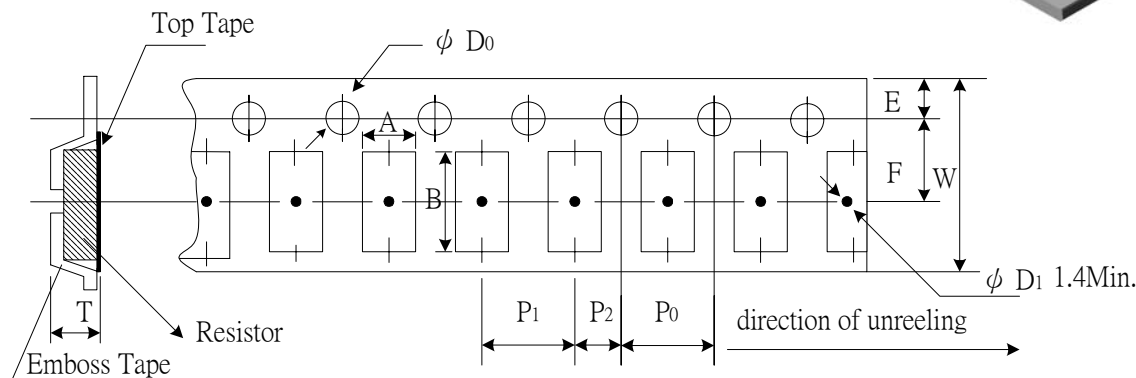

Unit: mm

Resistance (mΩ)	A	B	W	E	F	P ₀	P ₁	P ₂	ΦD ₀	T
0.50	3.40±0.1	6.70±0.1	12.0±0.1	1.75±0.1	5.5±0.05	4.0±0.05	4.00±0.1	2.0±0.05	1.50±0.1	1.40±0.1
0.75	3.50±0.1	6.80±0.2	12.0±0.1	1.75±0.1	5.5±0.05	4.0±0.05	4.00±0.1	2.0±0.05	1.50±0.1	1.35±0.1
1~20	3.40±0.1	6.70±0.1	12.0±0.1	1.75±0.1	5.5±0.05	4.0±0.05	4.00±0.1	2.0±0.05	1.50±0.1	0.80±0.1

Notice:

- The cumulative tolerance of 10 sprocket hole pitch is ±0.2mm.
- Carrier camber shall be not more than 1mm per 100mm through a length of 250mm.
- A & B measured 0.3mm from the bottom of the packet
- t measured at a point on the inside bottom of the packet to the top surface of the carrier.
- Pocket position relative to sprocket hole is measured as the true position of the pocket and not the pocket hole.

Environmental Characteristics

Item	Specification		Test Method
	Black coating	Green coating	
1 Temperature Coefficient of Resistance	As Spec.		MIL-STD-202F- Method 304 +25/-55/+25/+125/+25°C
2 Thermal Shock	±(0.5%+0.5mΩ)	±1%	MIL-STD-202F- Method 107G -55°C~150°C, 100 cycles
3 Short Time Overload	±(0.5%+0.5mΩ)	±1%	JIS-C-5202-5.5 5×rated power · 5 seconds
4 Resistance to Dry Heat	±(1%+0.5mΩ)	±1%	JIS-C-5202-7.2 96 hours @ +155°C without load
5 Load Life	±(1%+0.5mΩ)	±1%	MIL-STD-202F-Method 108A RCWV, 70°C, 1.5 hours on, 0.5 hours off, total 1000~1048 hours
6 Resistance to Soldering Heat	±(0.5%+0.5mΩ)	±1%	MIL-STD-202F-Method 210E 260±5°C, 10±1seconds
7 Solderability	95% min coverage		MIL-STD-202F-Method 208H 235±5°C, 2±0.5seconds

* Storage Temperature :25±3°C; Humidity <80%RH