

■ BOURNS-3296W 电位器模样图 ↓

■ BOURNS-3296W 尺寸图 ↓

Features

- Multiturn / Cermet / Industrial / Sealed
- 5 terminal styles
- Tape and reel packaging available
- Chevron seal design
- Listed on the QPL for style RJ24 per MIL-R-22097 and RJR24 per High-Rel Mil-R-39035

■ 技术参考数据 ↓

Electrical Characteristics	Environmental Characteristics
Standard Resistance Range 10 to 5 megohms (see standard resistance table)	Power Rating (300 volts max.) 70°C 0.5 watt 125°C 0 watt
Resistance Tolerance ±10% std. (tighter tolerance available)	Temperature Range -55°C to +150°C
Absolute Minimum Resistance 1% or 2 ohms max. (whichever is greater)	Temperature Coefficient ±100ppm/°C
Contact Resistance Variation 1.0% or 3 ohms max. (whichever is greater)	Seal Test 85°C Fluorinert*
Adjustability	Humidity MIL-STD-202 Method 103 96 hours (2% ΔTR, 10 Megohms IR)
Voltage ±0.01%	Vibration 20G (1% ΔTR; 1% ΔVR)
Resistance ±0.05%	Shock 100G (1% ΔTR; 1% ΔVR)
Resolution Infinite	Load Life 1,000 hours 0.5 watt @ 70°C (3% ΔTR; 3% or 3 ohms, whichever is greater, CRV)
Insulation Resistance 500 vdc. 1,000 megohms min.	Rotational Life 200 cycles (4% ΔTR; 3% or 3 ohms, whichever is greater, CRV)
Dielectric Strength	
Sea Level 900 vac	
70,000 Feet 350 vac	
Effective Travel 25 turns nom.	

Physical Characteristics

- Torque 3.0 oz-in. max.
- Mechanical Stops Wiper idles
- Terminals Solderable pins
- Weight 0.03 oz.
- Marking Manufacturer's
trademark, resistance code,
wiring diagram, date code,
manufacturer's model
number and style
- Wiper Positioned at 50% nominal
- Flammability U.L. 94V-0
- Standard Packaging 50 pcs. per tube
- Adjustment Tool H-90

*"FLUORINERT" IS A REGISTERED TRADEMARK OF 3M CO.

Specifications are subject to change without notice.

How to order

3296 W - 1 - 103

Model _____
 Style _____
 Standard or Modified Product Indicator
 -1 = Standard Product
 Resistance Code _____
 Consult factory for other available options.

Standard Resistance Table

Resistance (Ohms)	Resistance Code
10	100
20	200
50	500
100	101
200	201
500	501
1,000	102
2,000	202
5,000	502
10,000	103
20,000	203
25,000	253
50,000	503
100,000	104
200,000	204
250,000	254
500,000	504
1,000,000	105
2,000,000	205

Popular values listed in boldface. Special resistances available.

Common Dimensions

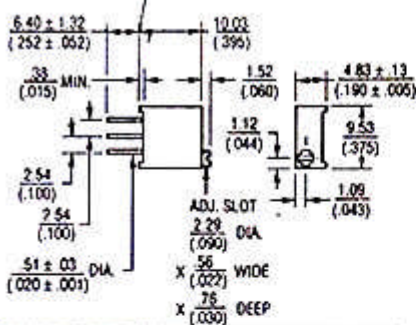

3296Y (Commercial Only)

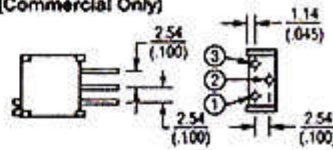

3296Z (Commercial Only)

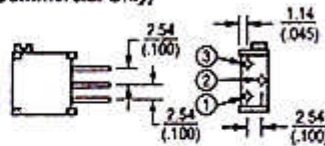

3296P

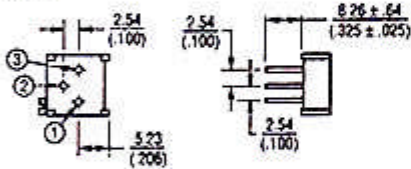

3296W

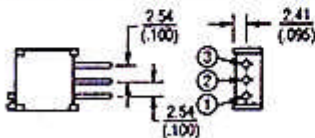

3296X

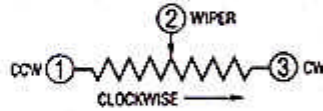
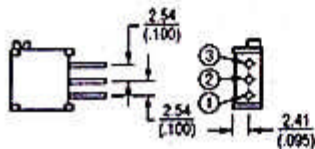

TOLERANCES: ± 0.25 (.010) EXCEPT WHERE NOTED

DIMENSIONS ARE: METRIC
(INCHES)