

Specification

Product Name: 0603High Bright White Chip LED

Part Number : FHS.CB0603QW1C

Customer : _____

CustomerPN: _____

Version: A.2

Date: 2010.04.01

Shen Zhen FuHengSheng Technology Co.,Ltd.

Client approval		
Approval	Audit	Confirmation
<input type="checkbox"/> Qualified	<input type="checkbox"/> Unqualified	

Instituted By: _____

Checked By: _____

ApprovedBy: _____

TEL:0755-83388102

FAX:0755-83375500

13 male beautiful Shen Zhen City Long Gang District
dragon city neighbourhood industry garden 4th floor

<http://www.szfhs.com>



1. Features

- (1) Package (L/W/H): 1.6 * 0.8 * 0.8 mm
- (2) Color: Ultra Bright Standard White
- (3) Lens Water Clear Flat Mold
- (4) EIA STD package
- (5) Meet ROHS, Green Product
- (6) Compatible With SMT Automatic Equipment
- (7) Compatible With Infrared Reflow Solder And Wave Solder Process



2. Package Profile & Soldering PAD Suggested

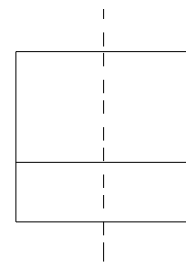
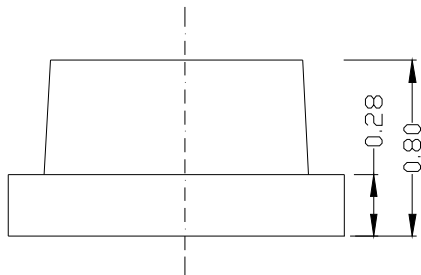
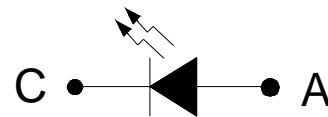
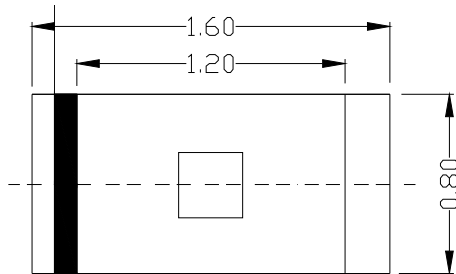

Soldering PAD Suggested

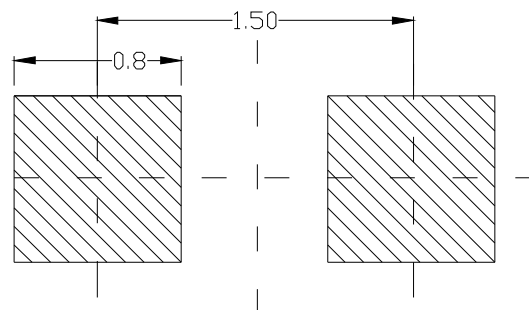
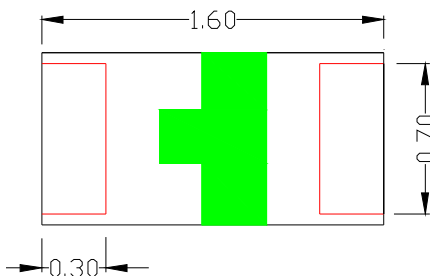

- Notes
1. All dimensions are in millimeters;
 2. Tolerance is ± 0.10 mm unless otherwise noted.



3. Soldering Profile Suggested

3.1、 For Lead Solder

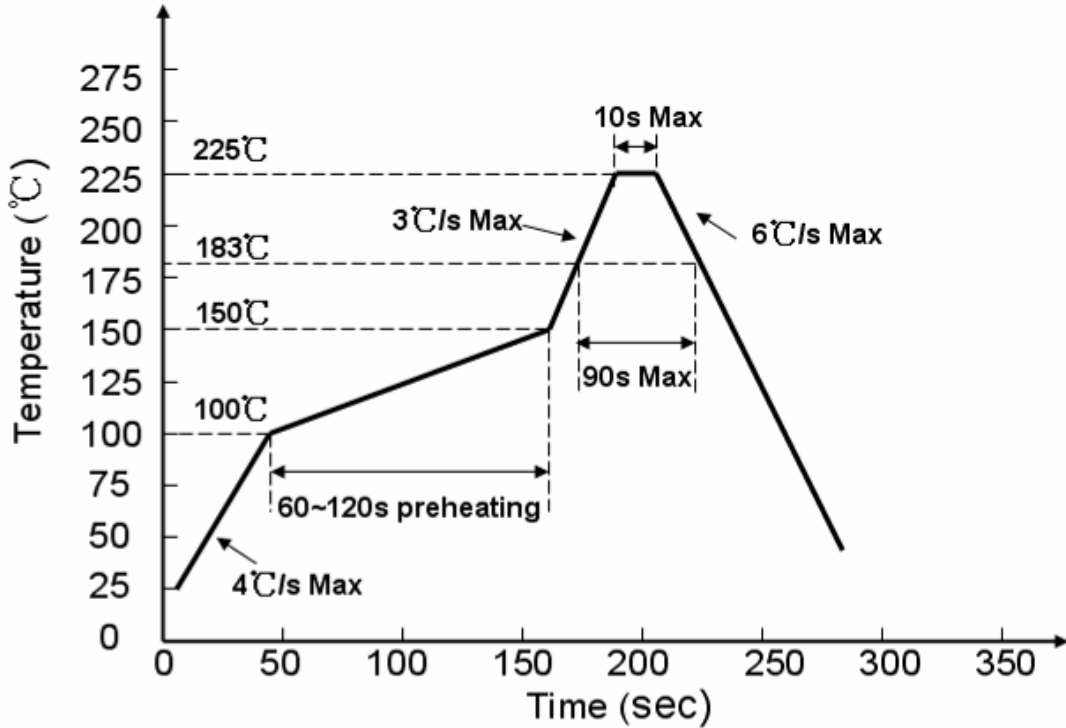

3.2、 For Lead Free Solder

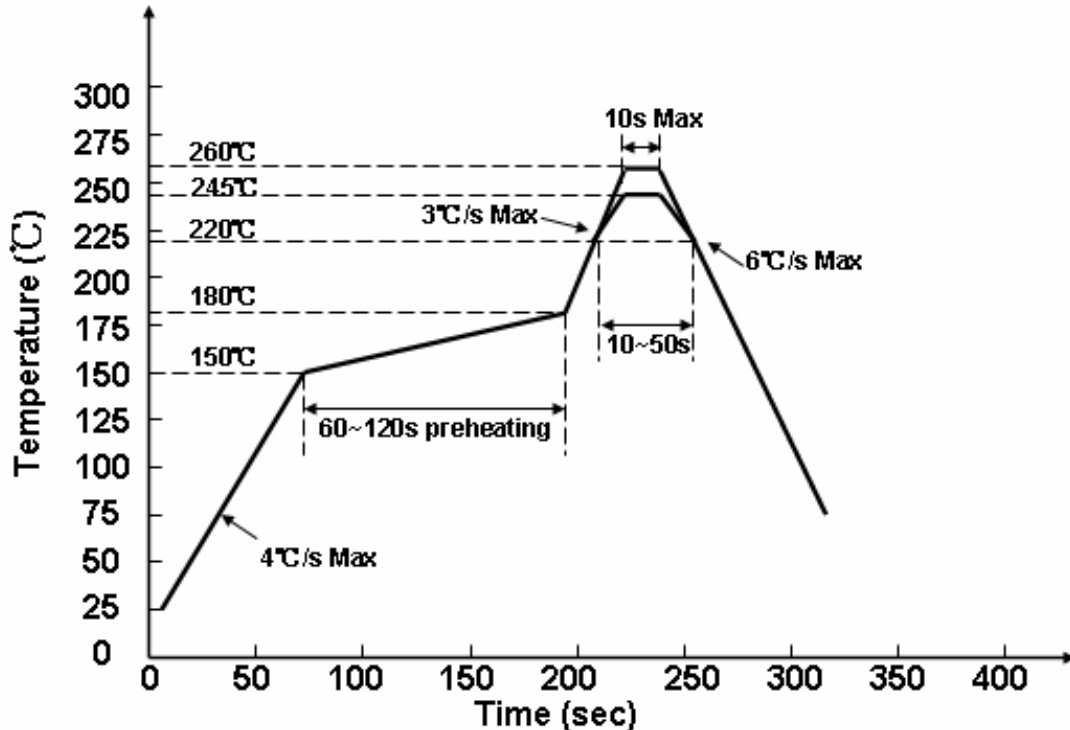

Notes:

We recommend the soldering temperature $245 \pm 5^{\circ}\text{C}$;
The maximum temperature should be limited to 260°C .



4. Absolute Maximum Ratings At Ta = 25°C

Parameter	Symbol	Rating	Unit
Power Dissipation	Pd	90	mW
Peak Forward Current (1/10 Duty Cycle, 0.1ms Pulse Width)	IFP	100	mA
DC Forward Current	IF	30	mA
Reverse Voltage	VR	5	V
Operating Temperature Range	Topr	-30°C ~ +85°C	
Storage Temperature Range	Tstg	-40°C ~ +90°C	
Soldering Condition	Tsol	Reflow soldering: 260°C For 5 Seconds Hand soldering: 300°C For 3 Seconds	



5. Electrical Optical Characteristics At $T_a=25^{\circ}\text{C}$

Parameter	Symbol	Min.	Typ.	Max.	Unit	TestCondition
Luminous Intensity	IV	---	480	---	mcd	IF = 20mA
Viewing Angle	$2\theta_{1/2}$	---	120	---	deg	IF = 20mA
CIE 1931 Coordinate	X/Y	---	X:0.29 Y:0.29	---		IF = 20mA
Forward Voltage	VF	2.8	---	3.6	V	IF=20mA
Reverse Current	IR	---	---	10	μA	VR=5V

- Notes
1. Luminous intensity is measured with a light sensor and filter combination that approximates the CIE eye-response curve .
 2. $\theta_{1/2}$ is the off-axis angle at which the luminous intensity is half the axial luminous intensity.
 3. The dominant wavelength, λ_d is derived from the CIE chromaticity diagram and represents the single wavelength which defines the color of the device .



6. Typical Electrical-Optical Characteristics Curves

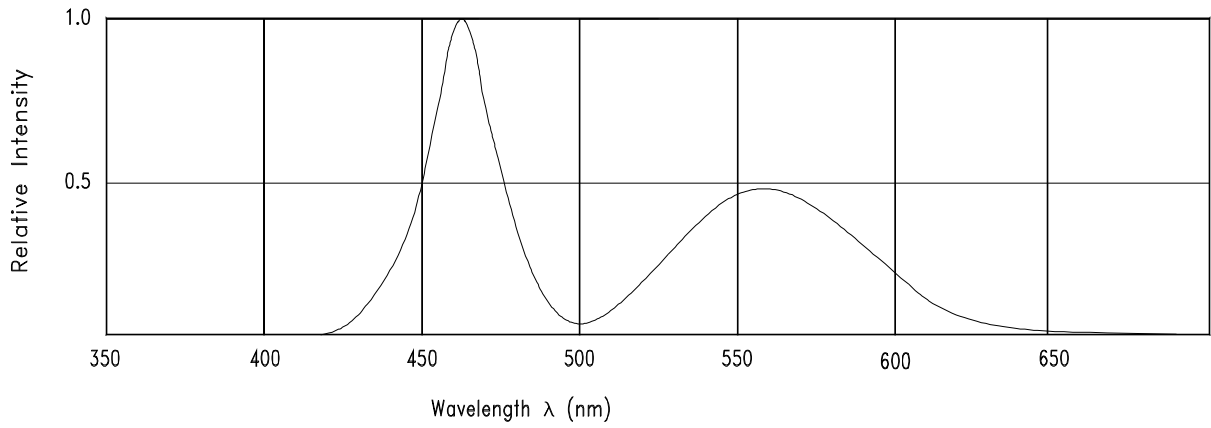

Fig.1 Relative Intensity vs. Wavelength

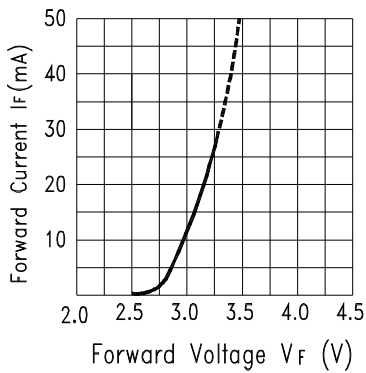

Fig.2 Forward Current vs. Forward Voltage

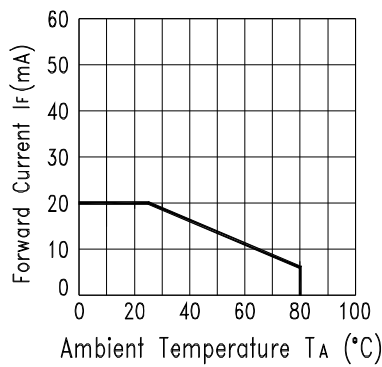

Fig.3 Forward Current Derating Curve

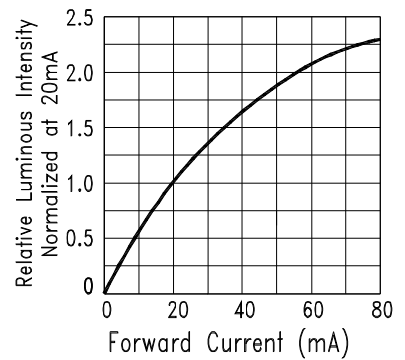

Fig.4 Relative Luminous Intensity vs. Forward Current

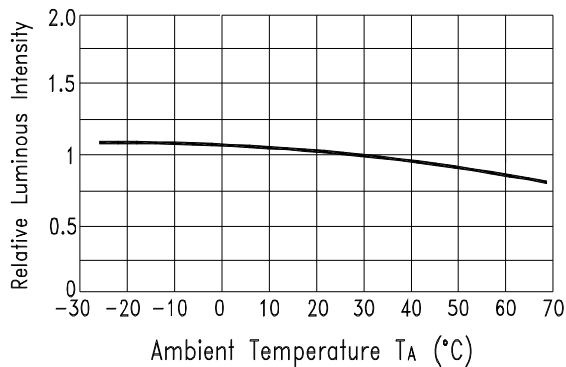

Fig.5 Luminous Intensity vs. Ambient Temperature

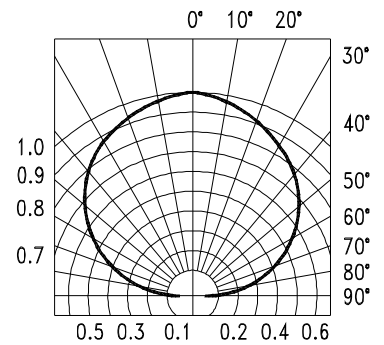
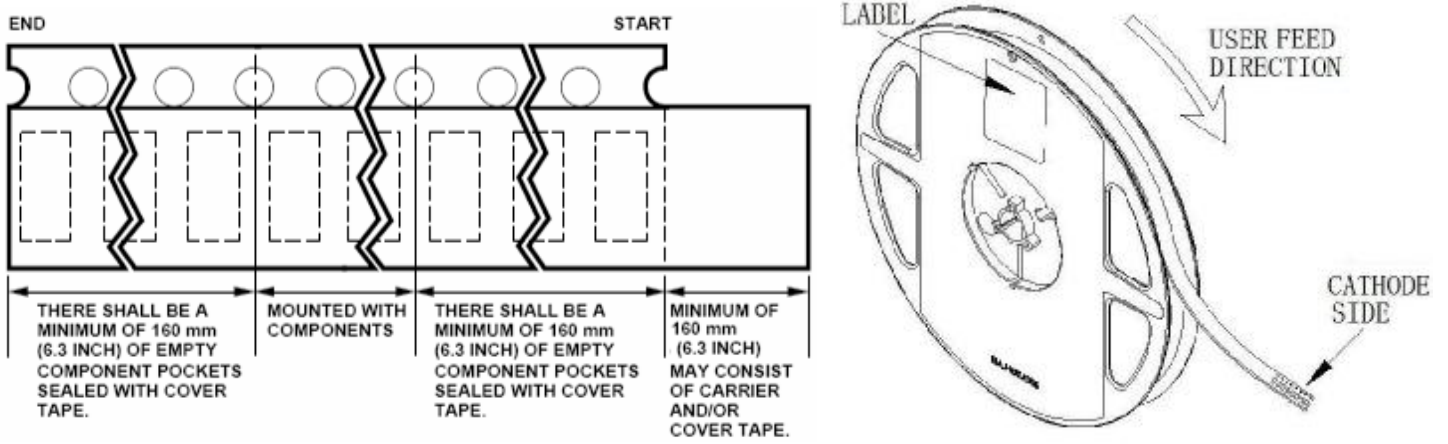

Fig.6 Spatial Distribution

9. Tape Leader & Trailer Dimensions And Reel



10. Packaging

