





Features

- Compliant with AEC-Q200 Rev-C- Stress Test Qualification for Passive Components in Automotive Applications
- 100 % electrically compatible with all previous generations of 1812 SMT devices
- Compatible with Pb and Pb-free solder reflow profiles
- RoHS compliant* and halogen free**
- Surface mount packaging for automated assembly
- Agency recognition:   
- Standard 4532 mm (1812 mils) footprint
- Patents pending

MF-MSMF Series - PTC Resettable Fuses

Electrical Characteristics

Model	V max. Volts	I max. Amps	I _{hold}	I _{trip}	Resistance		Max. Time To Trip		Tripped Power Dissipation
			Amperes at 23 °C		Ohms at 23 °C		Amperes at 23 °C	Seconds at 23 °C	Watts at 23 °C
			Hold	Trip	R _{Min.}	R _{1Max.}			Typ.
MF-MSMF010	60.0	40	0.10	0.30	0.70	15.00	0.5	1.50	0.8
MF-MSMF014	60.0	40	0.14	0.34	0.40	6.50	1.5	0.15	0.8
MF-MSMF020	30.0	80	0.20	0.40	0.40	6.00	6.0	0.06	0.8
MF-MSMF020/60	60.0	40	0.20	0.40	0.40	6.00	1.5	0.15	0.8
MF-MSMF030	30.0	10	0.30	0.60	0.30	3.00	8.0	0.10	0.8
MF-MSMF050	15.0	100	0.50	1.00	0.15	1.00	8.0	0.15	0.8
MF-MSMF075	13.2	100	0.75	1.50	0.11	0.45	8.0	0.20	0.8
MF-MSMF075/24	24.0	40	0.75	1.50	0.11	0.45	8.0	0.20	0.8
MF-MSMF110	6.0	100	1.10	2.20	0.04	0.21	8.0	0.30	0.8
MF-MSMF110/16	16.0	100	1.10	2.20	0.04	0.21	8.0	0.30	0.8
NEW! MF-MSMF110/24X***	24.0	20	1.10	2.20	0.06	0.18	8.0	0.50	0.8
MF-MSMF125	6.0	100	1.25	2.50	0.035	0.14	8.0	0.40	0.8
MF-MSMF150	6.0	100	1.50	3.00	0.03	0.120	8.0	0.5	0.8
MF-MSMF150/24X***	24.0	20	1.50	3.00	0.03	0.120	8.0	1.50	1.0
MF-MSMF160	8.0	100	1.60	2.80	0.035	0.099	8.0	2.0	0.8
MF-MSMF200	8.0	40	2.00	4.00	0.020	0.080	8.0	3.0	0.8
MF-MSMF250/16X***	16.0	100	2.50	5.00	0.015	0.100	8.0	5.0	1.2
MF-MSMF260	6.0	100	2.60	5.20	0.015	0.080	8.0	5.0	0.8

*** Features Multifuse® freeXpansion Design™ for MF-MSMF Series (CSA/TÜV pending)

Environmental Characteristics

Operating Temperature.....	-40 °C to +85 °C
Maximum Device Surface Temperature in Tripped State	125 °C
Passive Aging	+85 °C, 1000 hours..... ±5 % typical resistance change
Humidity Aging	+85 °C, 85 % R.H. 1000 hours..... ±5 % typical resistance change
Thermal Shock	+85 °C to -40 °C, 20 times..... ±10 % typical resistance change
Solvent Resistance.....	MIL-STD-202, Method 215..... No change
Vibration	MIL-STD-883C, Method 2007.1, Condition A..... No change

Test Procedures And Requirements For Model MF-MSMF Series

Test	Test Conditions	Accept/Reject Criteria
Visual/Mech.....	Verify dimensions and materials.....	Per MF physical description
Resistance.....	In still air @ 23 °C.....	R _{min} ≤ R ≤ R _{1max}
Time to Trip.....	At specified current, V _{max} , 23 °C.....	T ≤ max. time to trip (seconds)
Hold Current.....	30 min. at I _{hold}	No trip
Trip Cycle Life.....	V _{max} , I _{max} , 100 cycles.....	No arcing or burning
Trip Endurance.....	V _{max} , 48 hours.....	No arcing or burning
Solderability.....	ANSI/J-STD-002.....	95 % min. coverage

UL File Number	E174545 http://www.ul.com/ Follow link to Certifications, then UL File No., enter E174545
CSA File Number.....	CA110338 http://directories.csa-international.org/ Under "Certification Record" and "File Number" enter 110338-0-000
TÜV Certificate Number	R 02057213 http://www.tuvdotcom.com/ Follow link to "other certificates", enter File No. 2057213

*RoHS Directive 2002/95/EC Jan 27 2003 including Annex.

**To be considered halogen free, each homogenous material can have a maximum concentration of 900 ppm of either bromine or chlorine.

Specifications are subject to change without notice.

Customers should verify actual device performance in their specific applications.

Applications

- Overcurrent and overtemperature protection of automotive electronics
- Hard disk drives
- PC motherboards
- PC peripherals
- Point-of-sale (POS) equipment
- PCMCIA cards
- USB port protection - USB 2.0, 3.0 & OTG
- HDMI 1.4 Source protection

MF-MSMF Series - PTC Resettable Fuses

BOURNS®

Product Dimensions (see next page for outline drawings)

Model	A		B		C		D	Style
	Min.	Max.	Min.	Max.	Min.	Max.	Min.	
MF-MSMF010	$\frac{4.37}{(0.172)}$	$\frac{4.73}{(0.186)}$	$\frac{3.07}{(0.121)}$	$\frac{3.41}{(0.134)}$	$\frac{0.70}{(0.028)}$	$\frac{1.10}{(0.043)}$	$\frac{0.30}{(0.012)}$	1
MF-MSMF014	$\frac{4.37}{(0.172)}$	$\frac{4.73}{(0.186)}$	$\frac{3.07}{(0.121)}$	$\frac{3.41}{(0.134)}$	$\frac{0.70}{(0.028)}$	$\frac{1.10}{(0.043)}$	$\frac{0.30}{(0.012)}$	1
MF-MSMF020	$\frac{4.37}{(0.172)}$	$\frac{4.73}{(0.186)}$	$\frac{3.07}{(0.121)}$	$\frac{3.41}{(0.134)}$	$\frac{0.70}{(0.028)}$	$\frac{1.10}{(0.043)}$	$\frac{0.30}{(0.012)}$	1
MF-MSMF020/60	$\frac{4.37}{(0.172)}$	$\frac{4.73}{(0.186)}$	$\frac{3.07}{(0.121)}$	$\frac{3.41}{(0.134)}$	$\frac{0.70}{(0.028)}$	$\frac{1.10}{(0.043)}$	$\frac{0.30}{(0.012)}$	1
MF-MSMF030	$\frac{4.37}{(0.172)}$	$\frac{4.73}{(0.186)}$	$\frac{3.07}{(0.121)}$	$\frac{3.41}{(0.134)}$	$\frac{0.70}{(0.028)}$	$\frac{1.10}{(0.043)}$	$\frac{0.30}{(0.012)}$	1
MF-MSMF050	$\frac{4.37}{(0.172)}$	$\frac{4.73}{(0.186)}$	$\frac{3.07}{(0.121)}$	$\frac{3.41}{(0.134)}$	$\frac{0.55}{(0.015)}$	$\frac{0.85}{(0.033)}$	$\frac{0.30}{(0.012)}$	1
MF-MSMF075	$\frac{4.37}{(0.172)}$	$\frac{4.73}{(0.186)}$	$\frac{3.07}{(0.121)}$	$\frac{3.41}{(0.134)}$	$\frac{0.55}{(0.015)}$	$\frac{0.85}{(0.033)}$	$\frac{0.30}{(0.012)}$	1
MF-MSMF075/24	$\frac{4.37}{(0.172)}$	$\frac{4.73}{(0.186)}$	$\frac{3.07}{(0.121)}$	$\frac{3.41}{(0.134)}$	$\frac{0.55}{(0.015)}$	$\frac{0.85}{(0.033)}$	$\frac{0.30}{(0.012)}$	1
MF-MSMF110	$\frac{4.37}{(0.172)}$	$\frac{4.73}{(0.186)}$	$\frac{3.07}{(0.121)}$	$\frac{3.41}{(0.134)}$	$\frac{0.45}{(0.018)}$	$\frac{0.85}{(0.033)}$	$\frac{0.30}{(0.012)}$	1
MF-MSMF110/16	$\frac{4.37}{(0.172)}$	$\frac{4.73}{(0.186)}$	$\frac{3.07}{(0.121)}$	$\frac{3.41}{(0.134)}$	$\frac{0.45}{(0.018)}$	$\frac{0.85}{(0.033)}$	$\frac{0.30}{(0.012)}$	1
MF-MSMF110/24X	$\frac{4.37}{(0.172)}$	$\frac{4.83}{(0.190)}$	$\frac{3.07}{(0.121)}$	$\frac{3.41}{(0.134)}$	$\frac{0.70}{(0.028)}$	$\frac{1.60}{(0.063)}$	$\frac{0.30}{(0.012)}$	2
MF-MSMF125	$\frac{4.37}{(0.172)}$	$\frac{4.73}{(0.186)}$	$\frac{3.07}{(0.121)}$	$\frac{3.41}{(0.134)}$	$\frac{0.55}{(0.015)}$	$\frac{0.85}{(0.033)}$	$\frac{0.30}{(0.012)}$	1
MF-MSMF150	$\frac{4.37}{(0.172)}$	$\frac{4.73}{(0.186)}$	$\frac{3.07}{(0.121)}$	$\frac{3.41}{(0.134)}$	$\frac{0.55}{(0.015)}$	$\frac{0.85}{(0.033)}$	$\frac{0.30}{(0.012)}$	1
MF-MSMF150/24X	$\frac{4.37}{(0.172)}$	$\frac{4.83}{(0.190)}$	$\frac{3.07}{(0.121)}$	$\frac{3.41}{(0.134)}$	$\frac{0.70}{(0.028)}$	$\frac{1.60}{(0.063)}$	$\frac{0.30}{(0.012)}$	2
MF-MSMF160	$\frac{4.37}{(0.172)}$	$\frac{4.73}{(0.186)}$	$\frac{3.07}{(0.121)}$	$\frac{3.41}{(0.134)}$	$\frac{0.55}{(0.015)}$	$\frac{0.85}{(0.033)}$	$\frac{0.30}{(0.012)}$	1
MF-MSMF200	$\frac{4.37}{(0.172)}$	$\frac{4.73}{(0.186)}$	$\frac{3.07}{(0.121)}$	$\frac{3.41}{(0.134)}$	$\frac{0.55}{(0.015)}$	$\frac{0.85}{(0.033)}$	$\frac{0.30}{(0.012)}$	1
MF-MSMF250/16X	$\frac{4.37}{(0.172)}$	$\frac{4.83}{(0.190)}$	$\frac{3.07}{(0.121)}$	$\frac{3.41}{(0.134)}$	$\frac{0.70}{(0.028)}$	$\frac{1.60}{(0.063)}$	$\frac{0.30}{(0.012)}$	2
MF-MSMF260	$\frac{4.37}{(0.172)}$	$\frac{4.73}{(0.186)}$	$\frac{3.07}{(0.121)}$	$\frac{3.41}{(0.134)}$	$\frac{0.48}{(0.019)}$	$\frac{0.85}{(0.033)}$	$\frac{0.30}{(0.012)}$	1

Packaging:

MF-MSMF010 through MF-MSMF030 = 1500 pcs. per reel.
 MF-MSMF050 through MF-MSMF200 & MF-MSMF260 = 2000 pcs. per reel.
 MF-MSMF110/24X = 1000 pcs. per reel.
 MF-MSMF150/24X & MF-MSMF250/16X = 1500 pcs. per reel.

DIMENSIONS: $\frac{\text{MM}}{\text{(INCHES)}}$

MF-MSMF Series - PTC Resettable Fuses

BOURNS®

Product Dimensions (see previous page for dimensions)

Style 1

Top and Bottom View

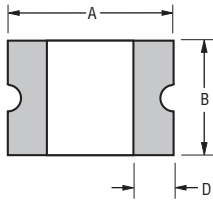

Side View

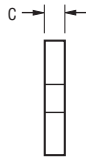

Recommended Pad Layout

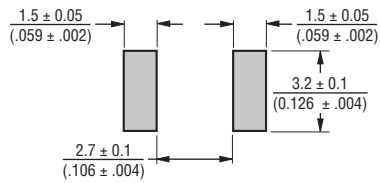

Terminal material:

Electroless Ni under immersion Au

Termination pad solderability:

Standard Au finish:
Meets ANSI/J-STD-002 Category 2.

Recommended Storage:

40 °C max./70 % RH max.

Style 2

Top View

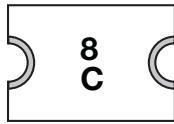

Bottom View

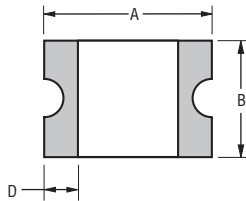

Side View

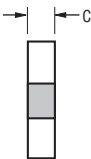

Recommended Pad Layout

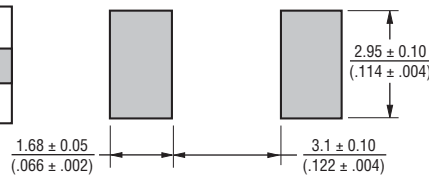

Typical Time to Trip at 23 °C

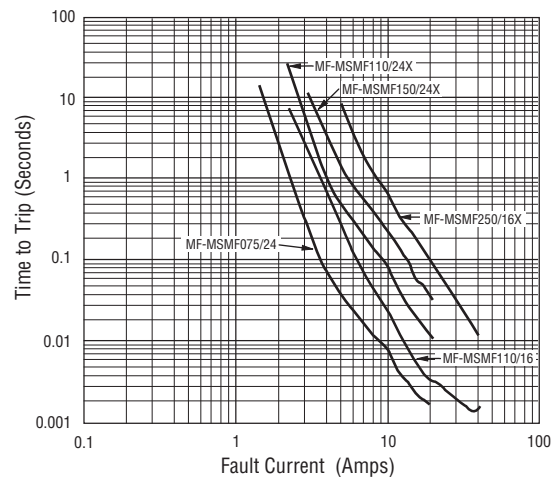
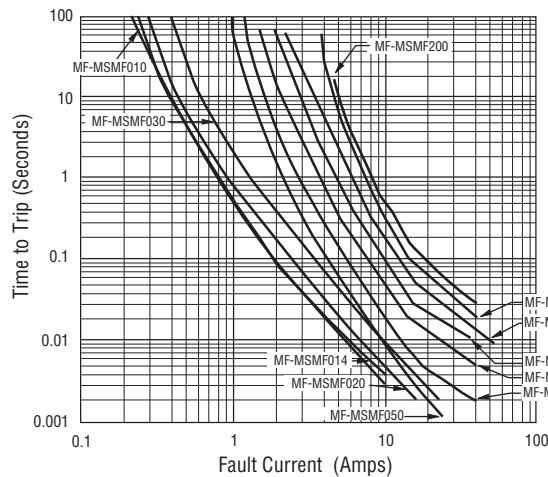

The Time to Trip curves represent typical performance of a device in a simulated application environment. Actual performance in specific customer applications may differ from these values due to the influence of other variables.

MF-MSMF Series - PTC Resettable Fuses

BOURNS®

Thermal Derating Chart - I_{hold} (Amps)

Model	Ambient Operating Temperature								
	-40 °C	-20 °C	0 °C	23 °C	40 °C	50 °C	60 °C	70 °C	85 °C
MF-MSMF010	0.16	0.14	0.12	0.10	0.08	0.07	0.06	0.05	0.03
MF-MSMF014	0.23	0.19	0.17	0.14	0.12	0.10	0.09	0.08	0.06
MF-MSMF020	0.29	0.26	0.23	0.20	0.17	0.15	0.14	0.12	0.10
MF-MSMF020/60	0.29	0.26	0.23	0.20	0.17	0.15	0.14	0.12	0.10
MF-MSMF030	0.44	0.39	0.35	0.30	0.26	0.23	0.21	0.18	0.15
MF-MSMF050	0.77	0.68	0.59	0.50	0.44	0.40	0.37	0.33	0.29
MF-MSMF075	1.15	1.01	0.88	0.75	0.65	0.60	0.55	0.49	0.43
MF-MSMF075/24	1.15	1.01	0.88	0.75	0.65	0.60	0.55	0.49	0.43
MF-MSMF110	1.59	1.43	1.26	1.10	0.95	0.87	0.80	0.71	0.60
MF-MSMF110/16	1.59	1.43	1.26	1.10	0.95	0.87	0.80	0.71	0.60
MF-MSMF110/24X	2.00	1.70	1.40	1.10	0.95	0.88	0.80	0.73	0.61
MF-MSMF125	1.80	1.63	1.43	1.25	1.08	0.99	0.91	0.81	0.68
MF-MSMF150	2.17	1.95	1.72	1.50	1.30	1.18	1.09	0.97	0.82
MF-MSMF150/24X	2.10	1.90	1.70	1.50	1.25	1.13	1.00	0.88	0.69
MF-MSMF160	2.30	2.20	1.90	1.60	1.45	1.30	1.15	1.03	0.91
MF-MSMF200	3.08	2.71	2.35	2.00	1.80	1.60	1.50	1.40	1.25
MF-MSMF250/16X	3.85	3.45	3.00	2.50	2.05	1.85	1.75	1.30	1.10
MF-MSMF260	4.00	3.52	3.06	2.60	2.34	2.08	1.95	1.39	1.04

Solder Reflow Recommendations

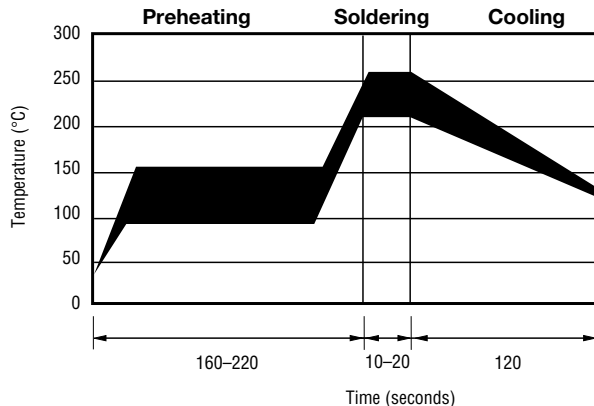

Notes:

- MF-MSMF models cannot be wave soldered. Please contact Bourns for hand soldering recommendations.
- If reflow temperatures exceed the recommended profile, devices may not meet the performance requirements.
- Compatible with Pb and Pb-free solder reflow profiles.
- Excess solder may cause a short circuit, especially during hand soldering. Please refer to the Multifuse® Polymer PTC Soldering Recommendation guidelines.

How to Order

MF - MSMF 075/24 - 2

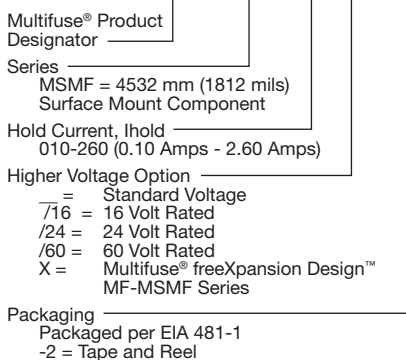

Typical Part Marking

Represents total content. Layout may vary.

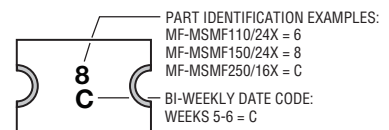
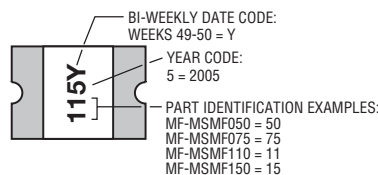

MF-MSMF SERIES, REV. AA, 04/10

"freeXpansion Design" is a trademark of Bourns, Inc. Specifications are subject to change without notice.

Customers should verify actual device performance in their specific applications.

MF-MSMF Series Tape and Reel Specifications

BOURNS®

Tape Dimensions	MF-MSMF010 - MF-MSMF030 per EIA-481-1	MF-MSMF050 - MF-MSMF260 per EIA 481-1	MF-MSMF-110/24X MF-MSMF150/24X MF-MSMF250/16X per EIA 481-1
W	$\frac{12.0 \pm 0.30}{(0.472 \pm 0.012)}$	$\frac{12.0 \pm 0.30}{(0.472 \pm 0.012)}$	$\frac{12.0 \pm 0.30}{(0.472 \pm 0.012)}$
P ₀	$\frac{4.0 \pm 0.10}{(0.157 \pm 0.004)}$	$\frac{4.0 \pm 0.10}{(0.157 \pm 0.004)}$	$\frac{4.0 \pm 0.10}{(0.157 \pm 0.004)}$
P ₁	$\frac{8.0 \pm 0.10}{(0.315 \pm 0.004)}$	$\frac{8.0 \pm 0.10}{(0.315 \pm 0.004)}$	$\frac{8.0 \pm 0.10}{(0.315 \pm 0.004)}$
P ₂	$\frac{2.0 \pm 0.05}{(0.079 \pm 0.002)}$	$\frac{2.0 \pm 0.05}{(0.079 \pm 0.002)}$	$\frac{2.0 \pm 0.05}{(0.079 \pm 0.002)}$
A ₀	$\frac{3.58 \pm 0.10}{(0.141 \pm 0.004)}$	$\frac{3.66 \pm 0.15}{(0.144 \pm 0.006)}$	$\frac{3.70 \pm 0.10}{(0.146 \pm 0.004)}$
B ₀	$\frac{4.93 \pm 0.10}{(0.194 \pm 0.004)}$	$\frac{4.98 \pm 0.10}{(0.196 \pm 0.004)}$	$\frac{5.10 \pm 0.10}{(0.200 \pm 0.004)}$
B ₁ max.	$\frac{5.9}{(0.232)}$	$\frac{5.9}{(0.232)}$	$\frac{5.9}{(0.232)}$
D ₀	$\frac{1.5 + 0.10/-0.0}{(0.059 + 0.004/-0)}$	$\frac{1.5 + 0.10/-0.0}{(0.059 + 0.004/-0)}$	$\frac{1.5 + 0.10/-0.0}{(0.059 + 0.004/-0)}$
F	$\frac{5.5 \pm 0.05}{(0.217 \pm 0.002)}$	$\frac{5.5 \pm 0.05}{(0.217 \pm 0.002)}$	$\frac{5.5 \pm 0.05}{(0.217 \pm 0.002)}$
E ₁	$\frac{1.75 \pm 0.10}{(0.069 \pm 0.004)}$	$\frac{1.75 \pm 0.10}{(0.069 \pm 0.004)}$	$\frac{1.75 \pm 0.10}{(0.069 \pm 0.004)}$
E ₂ min.	$\frac{10.25}{(0.404)}$	$\frac{10.25}{(0.404)}$	$\frac{10.25}{(0.404)}$
T max.	$\frac{0.6}{(0.024)}$	$\frac{0.6}{(0.024)}$	$\frac{0.6}{(0.024)}$
T ₁ max.	$\frac{0.1}{(0.004)}$	$\frac{0.1}{(0.004)}$	$\frac{0.1}{(0.004)}$
K ₀	$\frac{1.30 \pm 0.10}{(0.051 \pm 0.004)}$	$\frac{0.95 \pm 0.10}{(0.037 \pm 0.004)}$	$\frac{1.50 \pm 0.10}{(0.059 \pm 0.004)}$
Leader min.	$\frac{390}{(15.35)}$	$\frac{390}{(15.35)}$	$\frac{390}{(15.35)}$
Trailer min.	$\frac{160}{(6.30)}$	$\frac{160}{(6.30)}$	$\frac{160}{(6.30)}$
Reel Dimensions			
A max.	$\frac{185}{(7.28)}$	$\frac{185}{(7.28)}$	$\frac{185}{(7.28)}$
N min.	$\frac{50}{(1.97)}$	$\frac{50}{(1.97)}$	$\frac{50}{(1.97)}$
W ₁	$\frac{12.4 + 2.0/-0.0}{(0.488 + 0.079/-0.0)}$	$\frac{12.4 + 2.0/-0.0}{(0.488 + 0.079/-0.0)}$	$\frac{12.4 + 2.0/-0.0}{(0.488 + 0.079/-0.0)}$
W ₂ max.	$\frac{18.4}{(0.724)}$	$\frac{18.4}{(0.724)}$	$\frac{18.4}{(0.724)}$

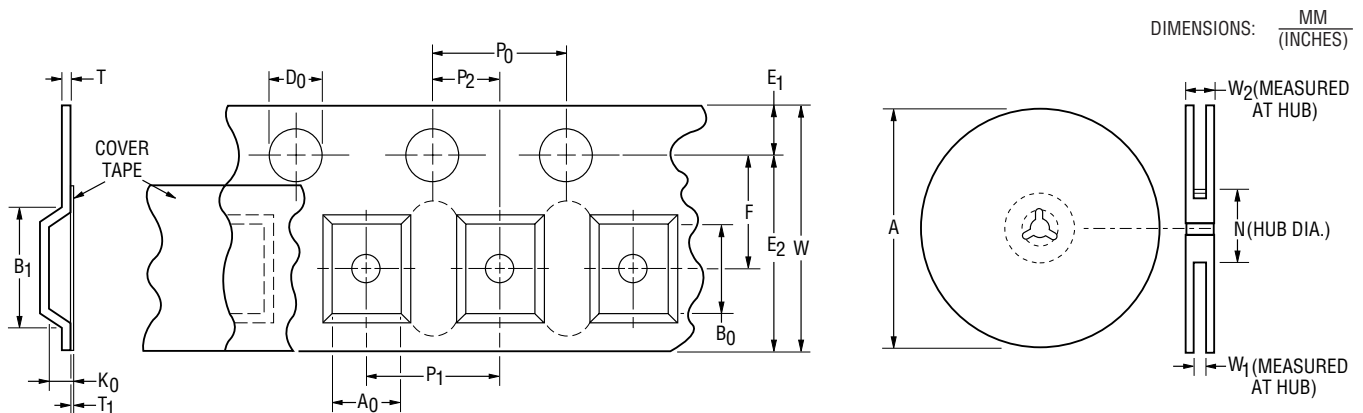

Specifications are subject to change without notice.
Customers should verify actual device performance in their specific applications