

# Power MOSFET

## 130 mAmps, 50 Volts

### P-Channel SOT-23

These miniature surface mount MOSFETs reduce power loss conserve energy, making this device ideal for use in small power management circuitry. Typical applications are dc-dc converters, load switching, power management in portable and battery-powered products such as computers, printers, cellular and cordless telephones.

- Energy Efficient
- Miniature SOT-23 Surface Mount Package Saves Board Space
- Pb-Free Package is available.

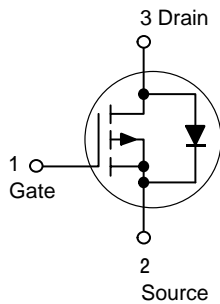

**MAXIMUM RATINGS** ( $T_J = 25^\circ\text{C}$  unless otherwise noted)

Rating	Symbol	Value	Unit
Drain-to-Source Voltage	$V_{DSS}$	50	V <sub>dc</sub>
Gate-to-Source Voltage – Continuous	$V_{GS}$	$\pm 20$	V <sub>dc</sub>
Drain Current			mA
– Continuous @ $T_A = 25^\circ\text{C}$	$I_D$	130	
– Pulsed Drain Current ( $t_p \leq 10 \mu\text{s}$ )	$I_{DM}$	520	
Total Power Dissipation @ $T_A = 25^\circ\text{C}$	$P_D$	225	mW
Operating and Storage Temperature Range	$T_J, T_{stg}$	- 55 to 150	$^\circ\text{C}$
Thermal Resistance – Junction-to-Ambient	$R_{\theta JA}$	556	$^\circ\text{C/W}$
Maximum Lead Temperature for Soldering Purposes, for 10 seconds	$T_L$	260	$^\circ\text{C}$

## LBSS84LT1G

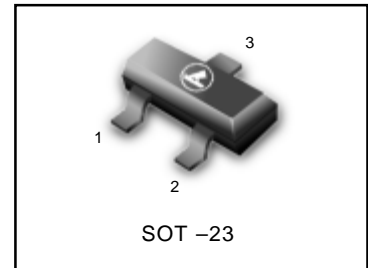

### Marking Diagram

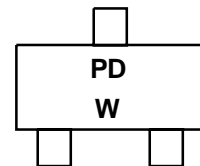

W = Work Week

### ORDERING INFORMATION

Device	Package	Shipping
LBSS84LT1G	SOT-23	3000/Tape&Reel
LBSS84LT3G	SOT-23	10000/Tape&Reel

**LBSS84LT1G**

**ELECTRICAL CHARACTERISTICS** ( $T_A = 25^\circ\text{C}$  unless otherwise noted)

Characteristic	Symbol	Min	Typ	Max	Unit
----------------	--------	-----	-----	-----	------

**OFF CHARACTERISTICS**

Drain-to-Source Breakdown Voltage ( $V_{GS} = 0\text{ Vdc}$ , $I_D = 250\ \mu\text{Adc}$ )	$V_{(BR)DSS}$	50	-	-	Vdc
Zero Gate Voltage Drain Current ( $V_{DS} = 25\text{ Vdc}$ , $V_{GS} = 0\text{ Vdc}$ ) ( $V_{DS} = 50\text{ Vdc}$ , $V_{GS} = 0\text{ Vdc}$ ) ( $V_{DS} = 50\text{ Vdc}$ , $V_{GS} = 0\text{ Vdc}$ , $T_J = 125^\circ\text{C}$ )	$I_{DSS}$	-	-	0.1 15 60	$\mu\text{Adc}$
Gate-Body Leakage Current ( $V_{GS} = \pm 20\text{ Vdc}$ , $V_{DS} = 0\text{ Vdc}$ )	$I_{GSS}$	-	-	$\pm 60$	$\mu\text{Adc}$

**ON CHARACTERISTICS** (Note 1.)

Gate-Source Threshold Voltage ( $V_{DS} = V_{GS}$ , $I_D = 1.0\text{ mAdc}$ )	$V_{GS(th)}$	0.8	-	2.0	Vdc
Static Drain-to-Source On-Resistance ( $V_{GS} = 5.0\text{ Vdc}$ , $I_D = 100\text{ mAdc}$ )	$r_{DS(on)}$	-	5.0	10	Ohms
Transfer Admittance ( $V_{DS} = 25\text{ Vdc}$ , $I_D = 100\text{ mAdc}$ , $f = 1.0\text{ kHz}$ )	$ y_{fs} $	50	-	-	mS

**DYNAMIC CHARACTERISTICS**

Input Capacitance	( $V_{DS} = 5.0\text{ Vdc}$ )	$C_{iss}$	-	30	-	pF
Output Capacitance	( $V_{DS} = 5.0\text{ Vdc}$ )	$C_{oss}$	-	10	-	
Transfer Capacitance	( $V_{DG} = 5.0\text{ Vdc}$ )	$C_{rss}$	-	5.0	-	

**SWITCHING CHARACTERISTICS** (Note 2.)

Turn-On Delay Time	$(V_{DD} = -15\text{ Vdc}$ , $I_D = -2.5\text{ Adc}$ , $R_L = 50\ \Omega$ )	$t_{d(on)}$	-	2.5	-	ns
Rise Time		$t_r$	-	1.0	-	
Turn-Off Delay Time		$t_{d(off)}$	-	16	-	
Fall Time		$t_f$	-	8.0	-	
Gate Charge		$Q_T$	-	6000	-	pC

**SOURCE-DRAIN DIODE CHARACTERISTICS**

Continuous Current	$I_S$	-	-	0.130	A
Pulsed Current	$I_{SM}$	-	-	0.520	
Forward Voltage (Note 2.)	$V_{SD}$	-	2.5	-	V

1. Pulse Test: Pulse Width  $\leq 300\ \mu\text{s}$ , Duty Cycle  $\leq 2\%$ .
2. Switching characteristics are independent of operating junction temperature.

**TYPICAL ELECTRICAL CHARACTERISTICS**

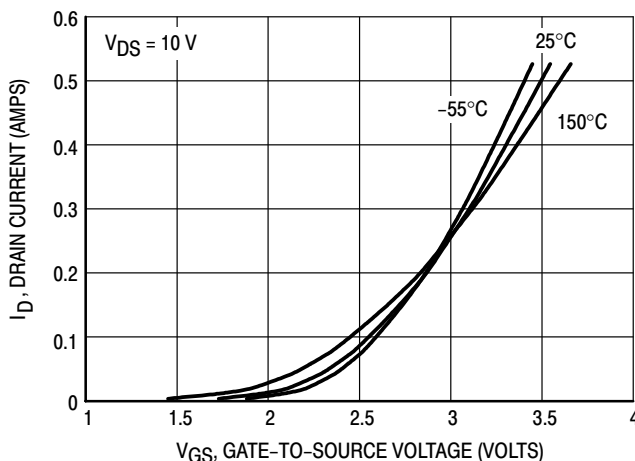

Figure 1. Transfer Characteristics

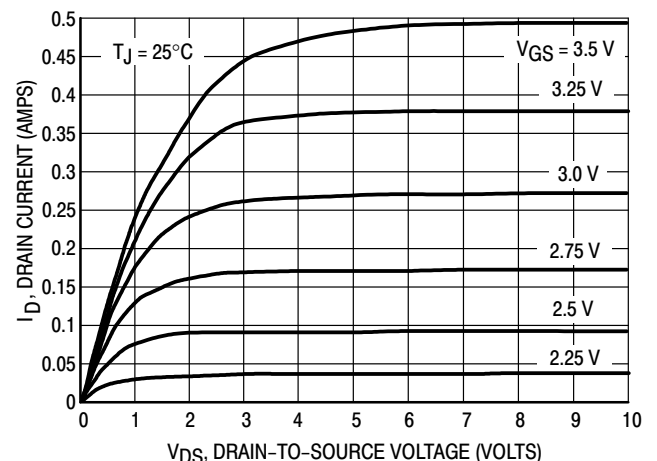

Figure 2. On-Region Characteristics

LBSS84LT1G

TYPICAL ELECTRICAL CHARACTERISTICS

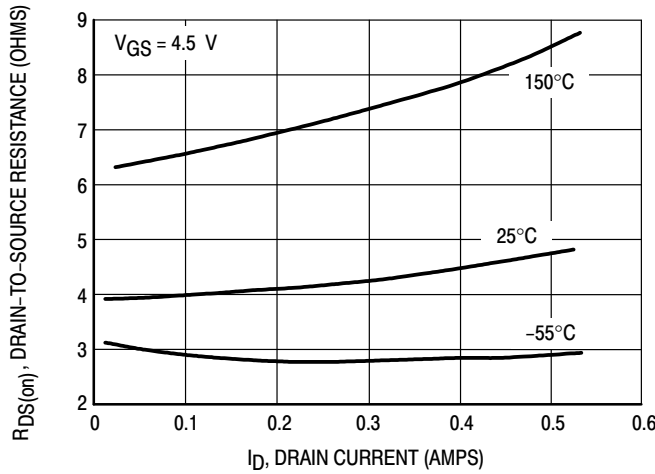

Figure 3. On-Resistance versus Drain Current

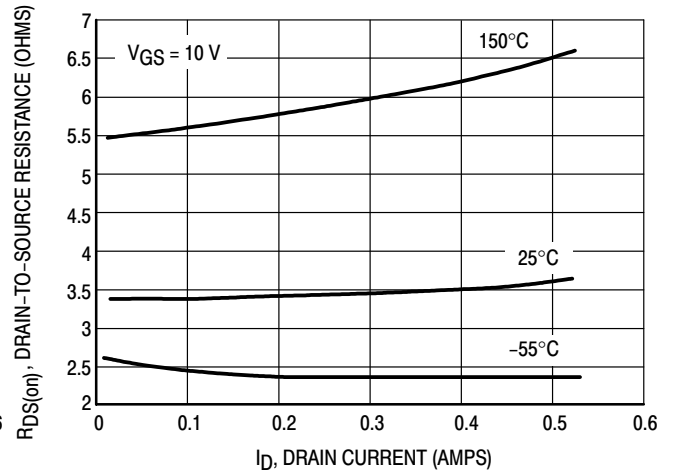

Figure 4. On-Resistance versus Drain Current

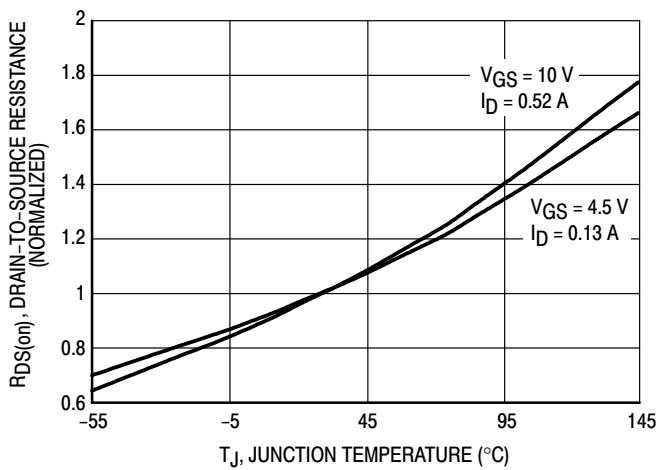

Figure 5. On-Resistance Variation with Temperature

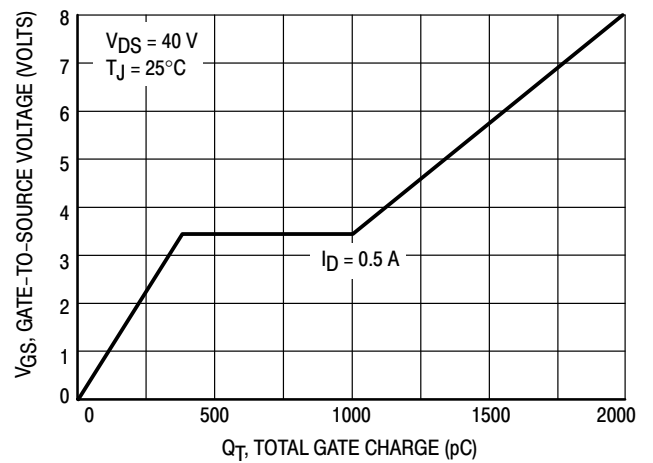

Figure 6. Gate Charge

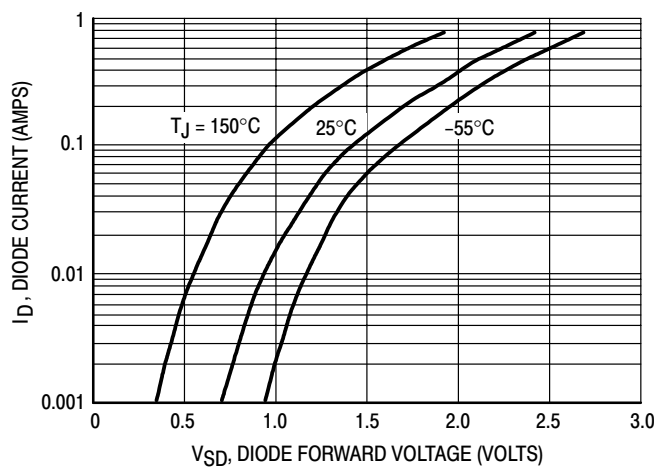
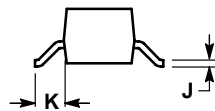
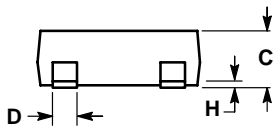
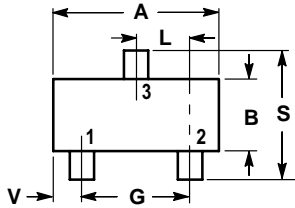

Figure 7. Body Diode Forward Voltage

**LBSS84LT1G**

**SOT-23**



**NOTES:**

1. DIMENSIONING AND TOLERANCING PER ANSI Y14.5M, 1982
2. CONTROLLING DIMENSION: INCH.

DIM	INCHES		MILLIMETERS	
	MIN	MAX	MIN	MAX
A	0.1102	0.1197	2.80	3.04
B	0.0472	0.0551	1.20	1.40
C	0.0350	0.0440	0.89	1.11
D	0.0150	0.0200	0.37	0.50
G	0.0701	0.0807	1.78	2.04
H	0.0005	0.0040	0.013	0.100
J	0.0034	0.0070	0.085	0.177
K	0.0140	0.0285	0.35	0.69
L	0.0350	0.0401	0.89	1.02
S	0.0830	0.1039	2.10	2.64
V	0.0177	0.0236	0.45	0.60

- PIN 1. BASE  
 2. EMITTER  
 3. COLLECTOR

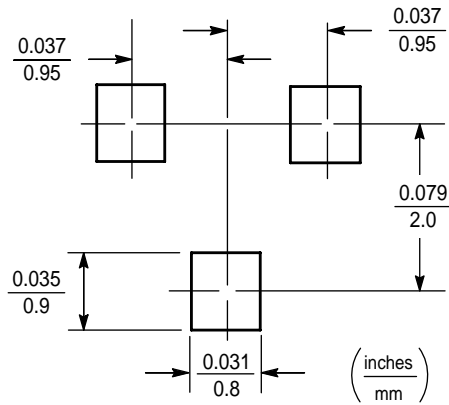

## EMBOSSED TAPE AND REEL DATA FOR DISCRETES

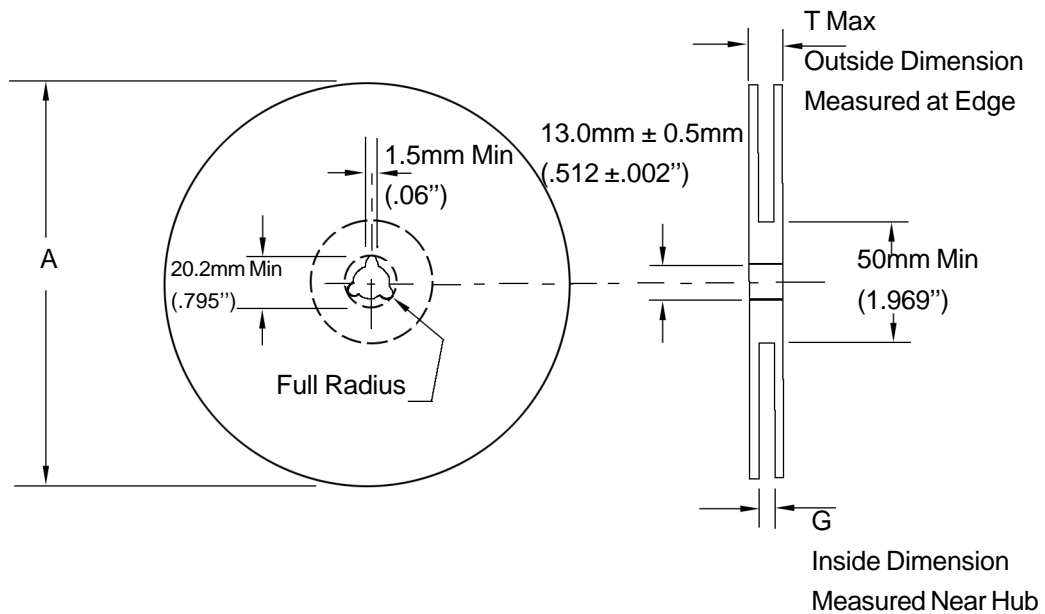

Size	A Max	G	T Max
8 mm	330mm (12.992")	8.4mm+1.5mm, -0.0 (.33"+.059", -0.00)	14.4mm (.56")
12mm	330mm (12.992")	12.4mm+2.0mm, -0.0 (.49 "+ .079", -0.00)	18.4mm (.72")
16mm	360mm (14.173")	16.4mm+2.0mm, -0.0 (.646"+.078", -0.00)	22.4mm (.882")
24 mm	360mm (14.173")	24.4mm+2.0mm, -0.0 (.961"+.070", -0.00)	30.4mm (1.197")

### Reel Dimensions

Metric Dimensions Govern — English are in parentheses for reference only

### Storage Conditions

Temperature: 5 to 40 Deg.C (20 to 30 Deg. C is preferred)

Humidity: 30 to 80 RH (40 to 60 is preferred )

Recommended Period: One year after manufacturing

(This recommended period is for the soldering condition only. The characteristics and reliabilities of the products are not restricted to this limitation)

## Shipment Specification

