

POWER RELAY

1 POLE—3, 5 A (MEDIUM LOAD CONTROL)

JY SERIES

■ FEATURES

- UL, CSA, VDE recognized
- High sensitivity and low power consumption
- High isolation
- Wide operating range
- DIL pitch terminals
- Plastic sealed type
- Socket mounting type and socket available
- Compatible with solid state relays type SJ (see page 365, 366) in size and pin (terminal) arrangement



■ ORDERING INFORMATION

[Example] $\frac{JY}{(a)} - \frac{12}{(*)} \frac{H}{(b)} \frac{E}{(c)} - \frac{K}{(e)} \frac{P^{*2}}{(f)}$

(a)	Series Name	JY : JY Series
(b)	Nominal Voltage	Refer to the COIL DATA CHART
(c)	Contact Style	Nil : 3 A (Single contact) H : 5 A (Single contact) W : 3A (Bifurcated contact)
(d)	Contact Material	Nil : Gold-plate silver alloy (single type) Nil : Gold overlay silver alloy (bifurcated) E : Silver alloy (single type)
(e)	Enclosure	K : Plastic sealed type
(f)	Terminal Classification	Nil : PC board mounting type P : Socket mounting type (without JY-W)

Note: 1. Actual marking omits the hyphen (-) of (*)
2. Actual marking omits the P of (*2)

■ SAFETY STANDARD AND FILE NUMBERS

UL508 (File No. E56140)

C22.2 No. 14 (File No. LR35579)

VDE 0435 (File No. 11039-4940-1014)

Please request when the approval markings are required on the cover and/or relay recognized by SEV is required.

Type	Nominal voltage	Contact rating
JY-H, JY-HE	4.5 to 48 VDC	1/8 HP 125 VAC/250 VAC 5 A 30 VDC/250 VAC, resistive Pilot duty C 150
JY, JY-W, JY-E	4.5 to 48 VDC	1/10 HP 125 VAC/250 VAC 3 A 30 VDC/250 VAC, resistive Pilot duty D 150

■ SPECIFICATIONS

Item		3 A Type			5 A Type	
		JY-() W-K	JY-() -K	JY-() E-K	JY-() H-K	JY-() HE-K
Contact	Arrangement	1 form A (SPST-NO)				
	Material	Gold-overlay silver alloy	Gold-plate silver alloy	silver alloy	Gold-plate silver alloy	silver alloy
	Style	Bifurcated	Single			
	Resistance (initial) (at 1A 6 VDC)	Maximum 30 mΩ		Max. 100 mΩ	Max. 30 mΩ	Max. 100 mΩ
	Rating (resistive)	3 A 250 VAC or 3 A 30 VDC		5 A 250 VAC or 5 A 30 VDC		
	Maximum Carrying Current	5 A				
	Maximum Switching Power	750 VA, 90 W			1,250 VA, 150 W	
	Maximum Switching Voltage	250 VAC, 150 VDC				
	Maximum Switching Current	3 A			5 A	
	Minimum Switching Load* ¹	0.1 mA 100 mVDC	10 mA 5 VDC	100 mA 5 VDC	10 mA 5 VDC	100 mA 5 VDC
Coil	Nominal Power (at 20°C)	0.2 W (48 V type: 0.36 W)				
	Operate Power (at 20°C)	0.1 W (48 V type: 0.17 W)				
	Operating Temperature	-40°C to +90°C (no frost) (48V type: +80°C)				
Time Value	Operate (at nominal voltage)	Maximum 6 ms				
	Release (at nominal voltage)	Maximum 3 ms				
Insulation	Resistance (at 500 VDC)	Minimum 1,000 MΩ				
	Dielectric	between open contacts	750 VAC 1 minute			
		between coil and contacts	Standard type 2,000 VAC 1 minute High dielectric strength type 3,000 VAC 1 minute			
Surge Strength	Standard type 4,000 V (at 1.2 × 50 μs) High dielectric strength type 5,000 V (at 1.2 × 50 μs)					
Life	Mechanical	2 × 10 ⁷ operations minimum				
	Electrical	1 × 10 ⁵ operations minimum (contact rating)				
Other	Vibration Resistance	Misoperation	10 to 55 Hz (double amplitude of 1.5 mm)			
		Endurance	10 to 55 Hz (double amplitude of 4.5 mm)			
	Shock Resistance	Misoperation	100 m/s ² (11±1 ms)			
		Endurance	1,000 m/s ² (6±1 ms)			
	Weight	Approximately 5 g				

*¹ Minimum switching loads mentioned above are reference values. Please perform the confirmation test with the actual load before production since reference values may vary according to switching frequencies, environmental conditions and expected reliability levels.

COIL DATA CHART

MODEL		Nominal voltage	Coil resistance ($\pm 10\%$)	Must operate voltage*1	Must release voltage*1	Nominal power
5 A Type	3 A Type					
JY-() H, JY-() HE	JY-(), JY-() W, JY-() E					
JY- 4.5 H ()-K	JY- 4.5 ()-K	4.5 VDC	100 Ω	3.1 VDC	0.23 VDC	200 mW
JY- 5 H ()-K	JY- 5 ()-K	5 VDC	125 Ω	3.5 VDC	0.25 VDC	200 mW
JY- 6 H ()-K	JY- 6 ()-K	6 VDC	180 Ω	4.2 VDC	0.3 VDC	200 mW
JY- 9 H ()-K	JY- 9 ()-K	9 VDC	405 Ω	6.3 VDC	0.45 VDC	200 mW
JY- 12 H ()-K	JY- 12 ()-K	12 VDC	720 Ω	8.4 VDC	0.6 VDC	200 mW
JY- 18 H ()-K	JY- 18 ()-K	18 VDC	1,620 Ω	12.6 VDC	0.9 VDC	200 mW
JY- 24 H ()-K	JY- 24 ()-K	24 VDC	2,880 Ω	16.8 VDC	1.2 VDC	200 mW
JY- 48 H ()-K	JY- 48 ()-K	48 VDC	6,400 Ω	32.6 VDC	2.4 VDC	360 mW
JY-101-K		23.5 VDC	2,760 Ω	15.5 VDC	1.18 VDC	200 mW
JY-105-K		12 VDC	720 Ω	8.4 VDC	0.6 VDC	200 mW
JY-107-K		5 VDC	125 Ω	3.5 VDC	0.25 VDC	200 mW

Note: *1 Specified values are subject to pulse wave voltage.
All values in the table are measured at 20°C.

CHARACTERISTIC DATA

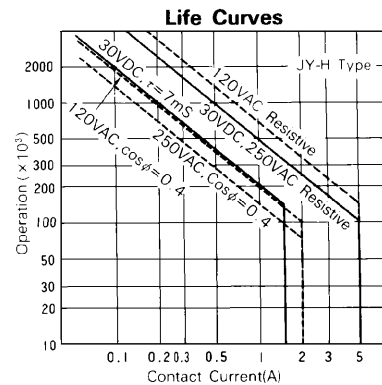
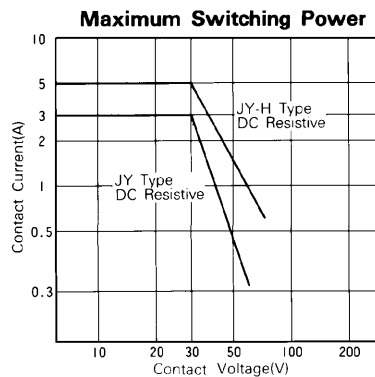
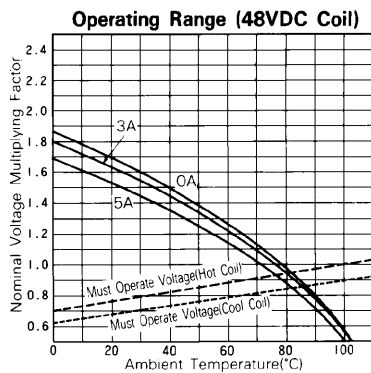
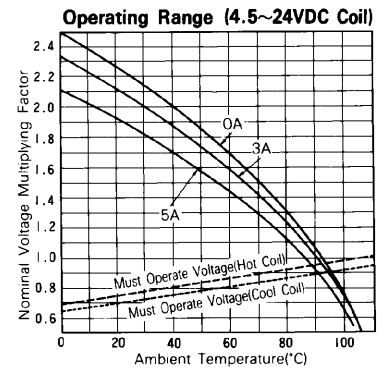
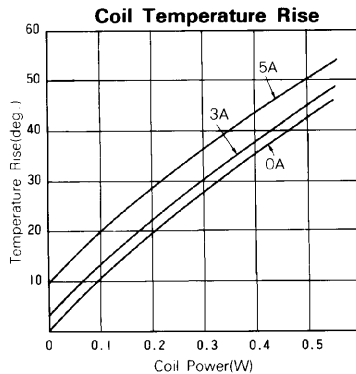
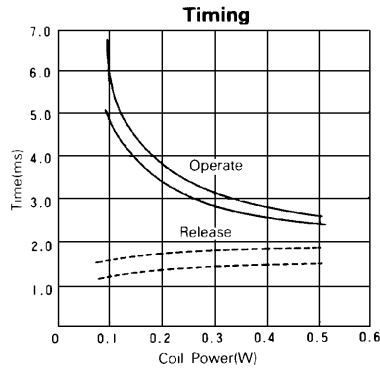

REFERENCE DATA

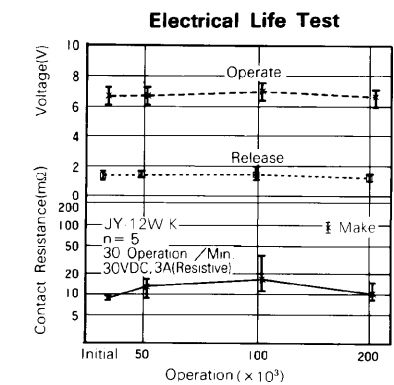
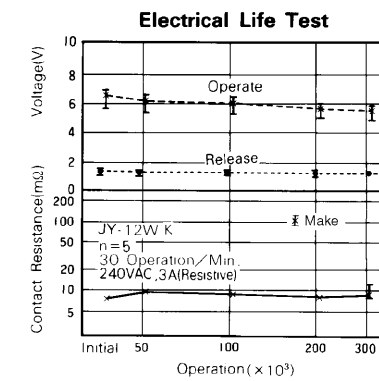
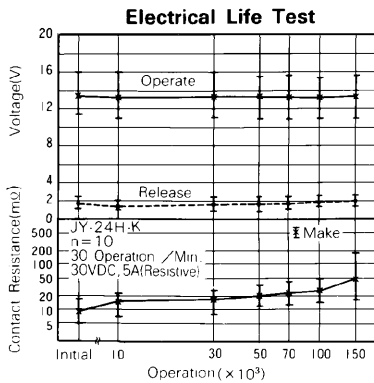
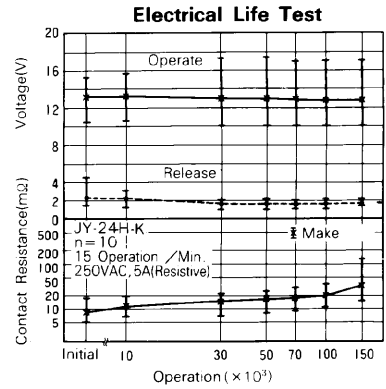
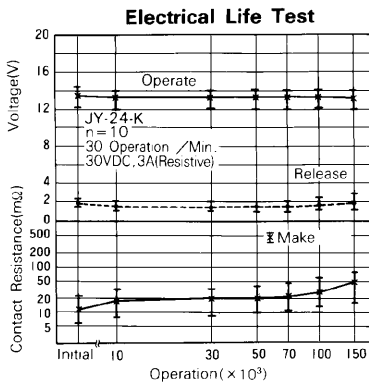
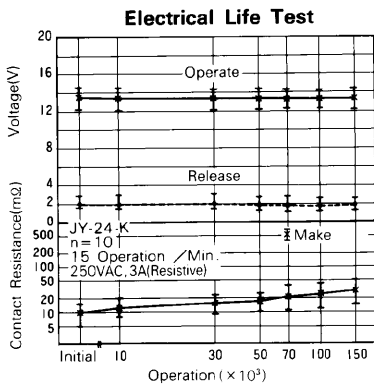
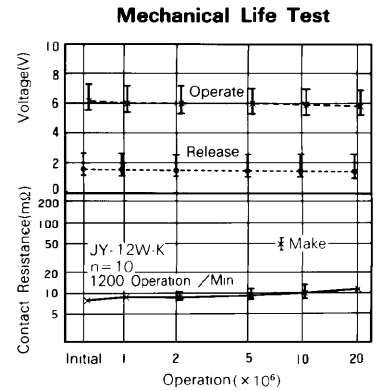
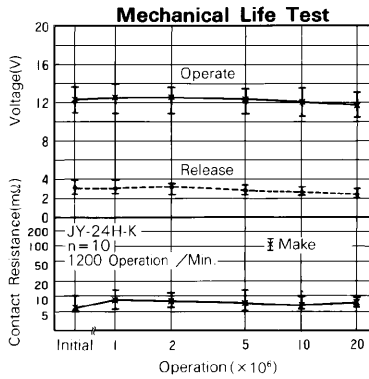
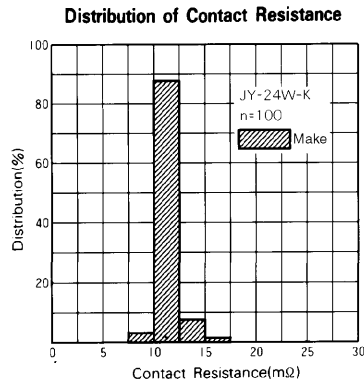
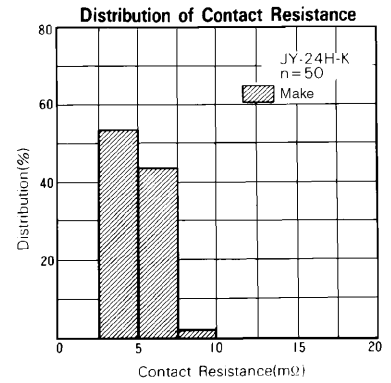
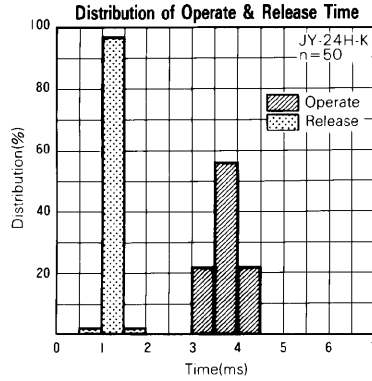
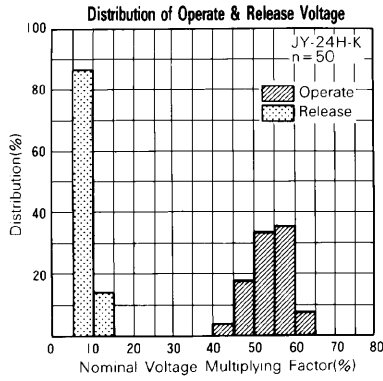

JY SERIES

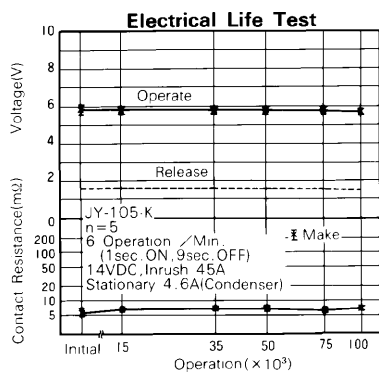

■ DIMENSIONS

● Dimensions

JY Type

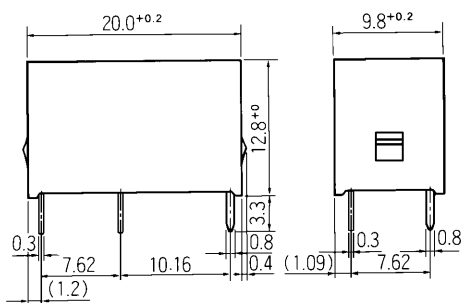

● Schematics (BOTTOM VIEW)

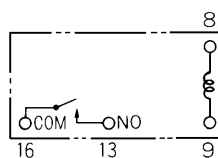

● PC board mounting hole layout (BOTTOM VIEW)

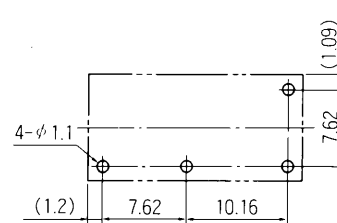

Unit: mm

■ SOCKET DIMENSIONS

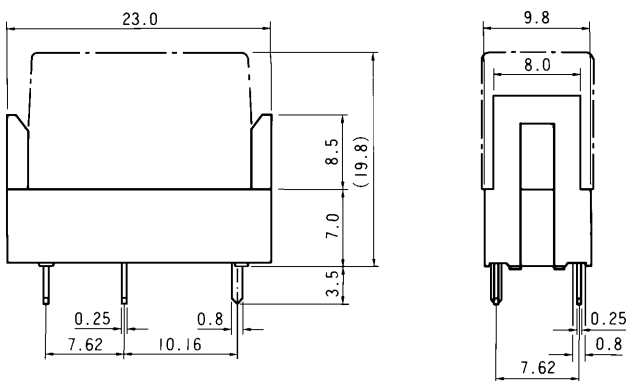

Unit: mm

■ NOTES

1. Socket ordering code : JK-4N
2. Standard IC socket is not recommended. Please use socket "JK-4N".

**Fujitsu Takamisawa
International
Headquarter
Offices**

www.fujitsu.takamisawa.com

Japan

Fujitsu Takamisawa Component Limited
Global Marketing and Sales
Gotanda-Chuo Building
3-5, Higashigotanda 2-chome, Shinagawa-ku
Tokyo 141, Japan
Tel: (81-3) 5449-7010
Fax: (81-3) 5449-2626

North and South America

Fujitsu Takamisawa America, Inc.
250 E. Caribbean Drive
Sunnyvale, CA 94089 U.S.A.
Tel: (1-408) 745-4900
Fax: (1-408) 745-4970

Europe

Fujitsu Takamisawa Europe B.V.
Diamantlaan 25
2132 WV Hoofddorp
Netherlands
Tel: (31-23) 5560910
Fax: (31-23) 5560950

Asia Pacific

Fujitsu Takamisawa Asia Pacific Pte. Ltd.
102E Pasir Panjang Road
#04-01 Citilink Warehouse Complex
Singapore 118529
Tel: (65) 375-8560
Fax: (65) 273-3021