

# 按动开关 2mm行程卧式 SPUJ系列

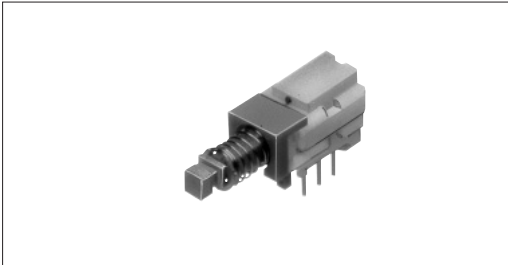

多回路对应可能的卧式。

- 检测
- 按动**
- 滑动
- 旋转
- 编码器
- 电源
- 切换式
- TACT Switch™
- 特别定做产品



### 主要规格

项目	规格	
最大额定/最小额定(电阻负荷)	0.1A 30V DC/50μA 3V DC	
接触电阻(初期/寿命后)	20mΩ max./40mΩ max.	
动作力	2回路	1.5±1N
	4回路	2.3±1N
操作寿命	无负载	10,000cycles
	负载	10,000cycles(0.1A 30V DC)

### 产品一览

切换时限	行程(mm)	全行程(mm)	安装方法	回路数	动作	端子形状	最小订货单位(pcs.)	产品编号
Non shorting	2	3	PC board	2	Latching	Straight	3,000	SPUJ190900
						Snap-in		SPUJ191000
					Momentary	Straight		SPUJ191500
						Snap-in		SPUJ191900
				4	Latching	Straight	2,000	SPUJ193700
						Snap-in		SPUJ193900
Momentary	Straight	SPUJ194500						

### 包装规格

散装

产品编号	包装数(pcs.)		出口包装箱尺寸(mm)
	1箱/日本	1箱/出口包装	
SPUJ190900,SPUJ191000,SPUJ191500,SPUJ191900	600	3,000	400×270×290
SPUJ193700,SPUJ193900,SPUJ194500	400	2,000	

- 卧式
- 立式

### 外形图

Unit:mm

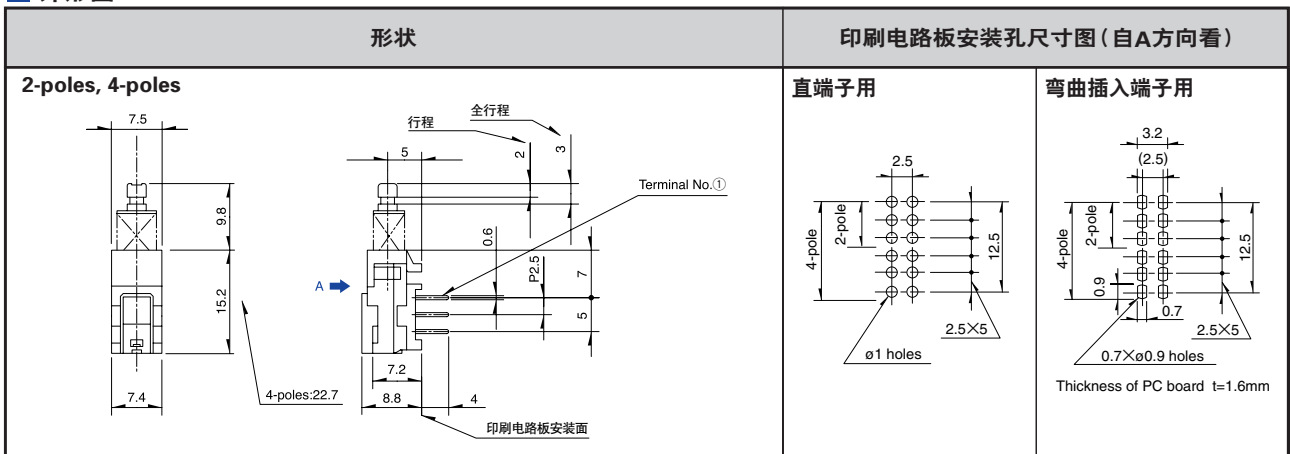

### 操作部尖端形状

Unit:mm

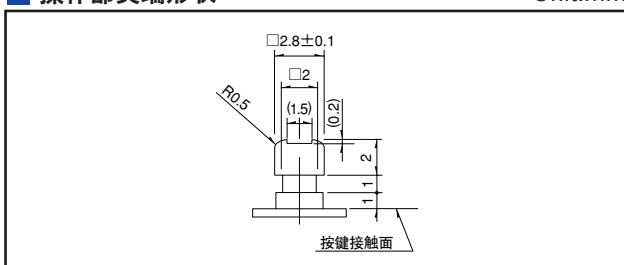

### 电路图(自A方向看)

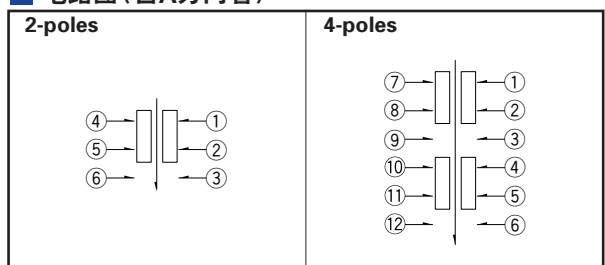

### 注

1. 还有上述产品一览以外的产品，需要时请向本公司营业部门询问。
2. 汽车用时，请进行洽谈。
3. 请以最小订购单位的N(整数)倍来订货。

## 产品系列一览

系列		SPEE	SPPJ6	SPPJ3	SPPJ2	SPUJ ※1	SPUP ※1	SPUN ※1	SPUN (中电流)※1	SPEG	SPEJ
照片											
行程 (mm)		0.3 0.71	1.5	2.5		2	1.5 2	2.5		1.1	1.7
全行程 (mm)		0.9	2.5	3.5		3	2.5 3	3.5		1.2	1.7
回路数		1	2	1 2	2	2 4				1	2
外形尺寸 (mm)	W	4	9	6.6	7.2	7.5		10		7.15	7
	D	5		12		15.2 22.7		24 36		8.35	7
	H	1.22	4.5	8.3	9.6	8.8	10.3	13		3.5	8
使用温度范围		-10°C to +60°C		-40°C to +85°C		-10°C to +60°C				-40°C to +85°C	
最大额定 (电阻负载)		20mA 5V DC	0.2A 12V DC	0.2A 30V DC		0.1A 30V DC		0.1A 30V DC	1A 25V DC	50mA 16V DC	0.2A 14V DC
最小额定 (电阻负载)		100µA 3V DC		50µA 3V DC				5µA 3V DC		50µA 3V DC	
电性能	初期接触电阻	※2	20mΩ max.						200mΩ max.	150mΩ max.	
	绝缘电阻	10MΩ min 100V DC	100MΩ min. 500V DC						3MΩ min. 100V DC	100MΩ min. 500V DC	
	耐电压	100V AC for 1minute	500V AC for 1minute						100V AC for 1minute	500V AC for 1minute	
机械性能	端子强度	5N for 1minute									0.5N for 1minute
	操作部 强度	工作方向	50N		30N		50N			50N	49N
		拉引方向	—		—		—			—	—
耐久性	无负载	100,000 cycles	10,000cycles 40mΩ max.				30,000cycles 40mΩ max.	10,000cycles 40mΩ max.	30,000cycles 500mΩ max.	10,000cycles	
	负载	100,000 cycles	10,000cycles 40mΩ max.				5,000cycles 40mΩ max.			10,000cycles 14V DC, 0.2A	
耐环境性能	耐寒性能	40±2°C for 96h	-20±2°C for 96h						-40±2°C for 500h		
	耐热性能	85±2°C for 96h									85±2°C for 500h
	耐湿性能	40±2°C, 90 to 95%RH for 96h									60±2°C, 90 to 95%RH for 500h
焊接耐热性能	手工焊接	350±10°C 4 <sup>+1</sup> 0s	350±10°C 3 <sup>+1</sup> 0s		300±10°C 3 <sup>+1</sup> 0s		350±10°C 3 <sup>+1</sup> 0s		350±5°C 3s max.	350±10°C 4s max.	
	浸焊	—	260±5°C 5±1s	260±5°C 10±1s	260±5°C 5±1s	260±5°C 10±1s		—	—		
	回流	请参照 P.133	—						请参照 P.133		
页		107	108	109	111	113	114	115		117	119

- 按动开关附属零部件 ..... 132
- 按动开关焊接条件 ..... 133
- 按动开关使用时的注意事项 ..... 134

### 注

- ※1. 关于汽车用途等宽温度使用范围, 可个别对应。如果需要请与本公司洽谈。
- ※2. 在规定输出电压1mA 5V DC时1V以下。

## 附属零部件

请指定希望的按键。

Unit:mm

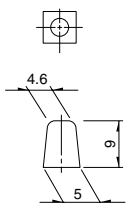
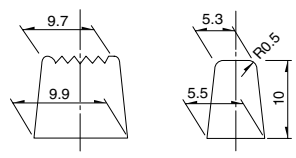
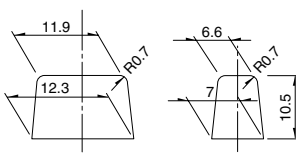
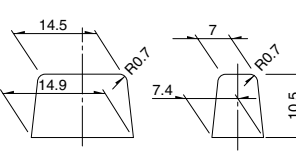
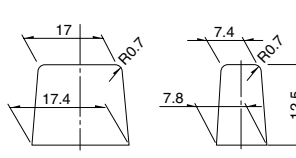
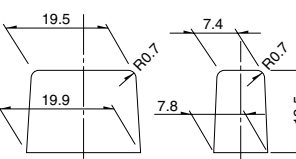
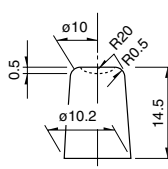
按键外形图	种类		适用系列
	Color	Model	
	Black Red White	UJ206022 UJ206020 UJ206026	SPPJ3 SPUJ
<p>键间距10mm</p> <p>方按键</p> 		4093-1 4093-2 4093-3	
<p>键间距12.5mm</p> <p>方按键</p> 		UE201011 UE201012 UE201013	
<p>键间距15mm</p> <p>方按键</p> 		UE202011 UE202012 UE202013	SPPJ2 SPUP SPUN SPEC
<p>键间距17.5mm</p> <p>方按键</p> 		UE203011 UE203012 UE203013	
<p>键间距20mm</p> <p>方按键</p> 		UE204011 UE204012 UE204013	
<p>圆按键</p> 		UE200011 UE200012 UE200013	

### 注

在开关上安装时，建议用粘结剂固定按键。

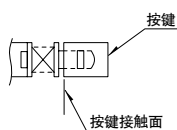

检测

按动

滑动

旋转

编码器

电源

切换式

TACT Switch™

特别定做  
产品

卧式

立式