

三坐标测针及组件

雷尼绍
RENISHAW
apply innovation

M2螺纹测针系列

M2螺纹测针系列

3.0

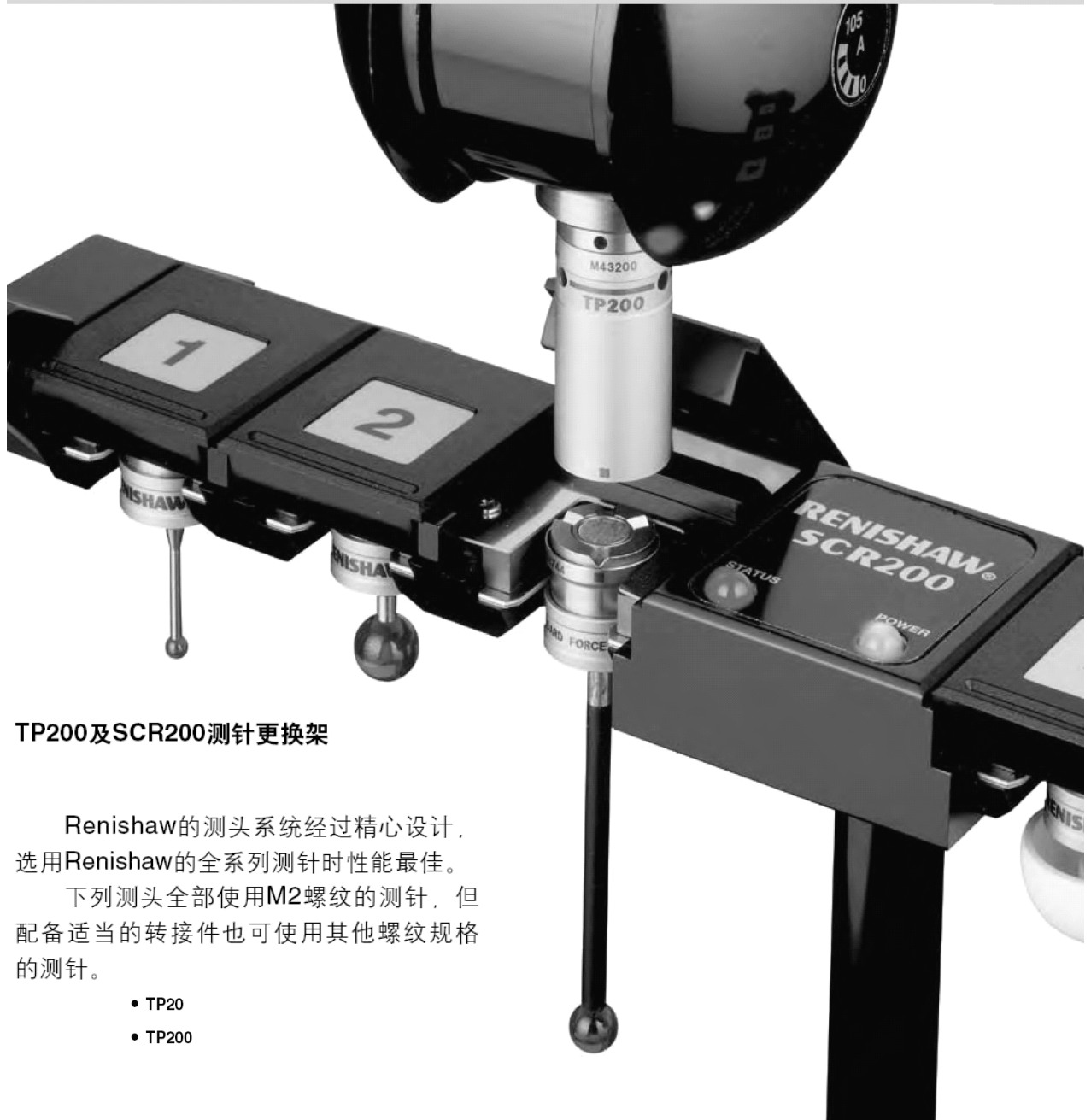

TP200及SCR200测针更换架

Renishaw的测头系统经过精心设计，选用Renishaw的全系列测针时性能最佳。

下列测头全部使用M2螺纹的测针，但配备适当的转接件也可使用其他螺纹规格的测针。

- TP20
- TP200

红宝石球测针（不锈钢测杆）



订货号	A-5000-7806	A-5000-7802	A-5000-7807	A-5000-7803	A-5000-3604	A-5000-4154	A-5000-4155	A-5000-4156	A-5000-4158
A 测球直径 mm (in.)	1.0 (0.04)	1.5 (0.06)	2.0 (0.08)	2.5 (0.10)	3.0 (0.12)	4.0 (0.16)	5.0 (0.20)	6.0 (0.24)	8.0 (0.32)
B 长度 mm (in.)	10.0 (0.40)	10.0 (0.40)	10.0 (0.40)	10.0 (0.40)	10.0 (0.40)	10.0 (0.40)	10.0 (0.40)	10.0 (0.40)	11.0 (0.44)
C 测杆直径 mm (in.)	0.7 (0.03)	0.7 (0.03)	1.0 (0.04)	1.0 (0.04)	1.5 (0.06)	1.5 (0.06)	2.5 (0.10)	2.5 (0.10)	2.5 (0.10)
D EWL* mm (in.)	4.5 (0.18)	4.5 (0.18)	6.0 (0.24)	6.0 (0.24)	7.5 (0.30)	10.0 (0.40)	10.0 (0.40)	10.0 (0.40)	11.0 (0.44)
质量 (克)	0.3	0.3	0.3	0.3	0.4	0.4	0.7	0.9	1.5

10 mm系列

订货号	A-5000-3603	A-5000-7804	A-5000-4160	A-5000-4161
A 测球直径 mm (in.)	2.0 (0.08)	2.5 (0.10)	3.0 (0.12)	4.0 (0.16)
B 长度 mm (in.)	20.0 (0.79)	20.0 (0.79)	20.0 (0.79)	20.0 (0.79)
C 测杆直径 mm (in.)	1.4 (0.06)	1.4 (0.06)	1.5 (0.06)	1.5 (0.06)
D EWL* mm (in.)	14.0 (0.56)	14.0 (0.56)	17.5 (0.69)	20.0 (0.79)
质量 (克)	0.4	0.4	0.5	0.6

20 mm系列

红宝石球测针（碳化钨测杆）

订货号	A-5000-7800	A-5000-7805	A-5000-7801	A-5003-1325
A 测球直径 mm (in.)	0.3 (0.012)	0.5 (0.02)	0.7 (0.03)	1.0 (0.04)
B 长度 mm (in.)	10.0 (0.40)	10.0 (0.40)	10.0 (0.40)	10.0 (0.40)
C 测杆直径 mm (in.)	0.2 (0.01)	0.4 (0.02)	0.5 (0.02)	0.7 (0.03)
D EWL* mm (in.)	2.0 (0.08)	3.0 (0.12)	4.0 (0.16)	4.0 (0.16)
质量 (克)	0.3	0.3	0.3	0.3

10 mm系列

订货号	A-5003-1345	A-5003-0577	A-5000-7808	A-5003-0033	A-5003-0034
A 测球直径 mm (in.)	0.5 (0.02)	0.7 (0.03)	1.0 (0.04)	1.0 (0.04)	1.5 (0.06)
B 长度 mm (in.)	20.0 (0.79)	20.0 (0.79)	20.0 (0.79)	20.0 (0.76)	20.0 (0.76)
C 测杆直径 mm (in.)	0.3 (0.012)	0.5 (0.02)	0.7 (0.03)	0.8 (0.04)	1.0 (0.04)
D EWL* mm (in.)	7.0 (0.28)	12.0 (0.48)	7.0 (0.28)	12.5 (0.50)	12.5 (0.50)
质量 (克)	0.48	0.32	0.50	0.41	0.50

20 mm系列

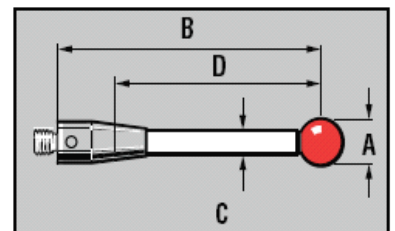

测针及附件

红宝石球测针（碳化钨测杆）

订货号	A-5003-0037	A-5003-0039	A-5003-0041	A-5003-0044	A-5003-0048	A-5003-0042	A-5003-0045	A-5003-0049
A 测球直径 mm (in.)	2.0 (0.08)	2.5 (0.10)	3.0 (0.12)	4.0 (0.16)	5.0 (0.20)	3.0 (0.12)	4.0 (0.16)	5.0 (0.20)
B 长度 mm (in.)	40.0 (1.58)	40.0 (1.58)	40.0 (1.58)	40.0 (1.58)	40.0 (1.58)	50.0 (1.97)	50.0 (1.97)	50.0 (1.97)
C 测杆直径 mm (in.)	1.5 (0.06)	2.0 (0.08)	2.0 (0.08)	2.0 (0.08)	2.5 (0.10)	2.0 (0.08)	2.0 (0.08)	2.5 (0.10)
D EWL* mm (in.)	35.0 (1.38)	35.0 (1.38)	35.0 (1.38)	40.0 (1.58)	40.0 (1.58)	42.5 (1.68)	50.0 (1.97)	50.0 (1.97)
质量 (克)	1.29	1.95	1.97	2.04	3.17	2.44	2.52	3.75

40 mm系列

50 mm系列

红宝石球测针（陶瓷测杆）

订货号	A-5003-0064	A-5003-0065	A-5003-0066	A-5003-0470
A 测球直径 mm (in.)	3.0 (0.12)	4.0 (0.16)	5.0 (0.20)	6.0 (0.24)
B 长度 mm (in.)	50.0 (1.97)	50.0 (1.97)	50.0 (1.97)	50.0 (1.97)
C 测杆直径 mm (in.)	2.0 (0.08)	2.0 (0.08)	2.5 (0.10)	2.5 (0.10)
D EWL* mm (in.)	42.5 (1.68)	50.0 (1.97)	50.0 (1.97)	50.0 (1.97)
质量 (克)	0.83	0.91	1.31	1.49

50 mm系列

红宝石球测针（碳纤维测杆）

订货号	A-5003-2285	A-5003-2286	A-5003-2287
A 测球直径 mm (in.)	4.0 (0.16)	5.0 (0.20)	6.0 (0.24)
B 长度 mm (in.)	50.0 (1.97)	50.0 (1.97)	50.0 (1.97)
C 测杆直径 mm (in.)	3.0 (0.12)	3.0 (0.12)	3.0 (0.12)
D EWL* mm (in.)	50.0 (1.97)	50.0 (1.97)	50.0 (1.97)
质量 (克)	1.00	1.10	1.20

50 mm系列

红宝石球测针（陶瓷测杆）

订货号	A-5003-4177	A-5003-1370	A-5003-4779	A-5003-4780
A 测球直径 mm (in.)	3.0 (0.12)	4.0 (0.16)	5.0 (0.20)	6.0 (0.24)
B 长度 mm (in.)	30.0 (1.19)	30.0 (1.19)	30.0 (1.19)	30.0 (1.19)
C 测杆直径 mm (in.)	2.0 (0.08)	2.0 (0.08)	2.5 (0.10)	2.5 (0.10)
D EWL* mm (in.)	27.5 (1.09)	30.0 (1.19)	30.0 (1.19)	30.0 (1.19)
质量 (克)	0.44	0.68	0.93	1.11

30 mm系列

红宝石球测针（碳纤维测杆）

订货号	A-5003-4241	A-5003-4781	A-5003-4782
A 测球直径 mm (in.)	4.0 (0.16)	5.0 (0.20)	6.0 (0.24)
B 长度 mm (in.)	30.0 (1.19)	30.0 (1.19)	30.0 (1.19)
C 测杆直径 mm (in.)	2.0 (0.08)	3.0 (0.12)	3.0 (0.12)
D EWL* mm (in.)	30.0 (1.19)	30.0 (1.19)	30.0 (1.19)
质量 (克)	0.57	0.79	0.96

30 mm系列

* 有效工作长度

M3螺纹测针系列

M3螺纹测针系列

4.0



带有两套FCR25以及交换架的SP25M

Renishaw的检测系统经过精心设计，选用Renishaw的全系列测针时性能最佳。下列测头全部使用M3螺纹测针，但配备适当的转接件也可使用其他螺纹规格的测针。

- TP6
- MIP
- SP25M

测针及附件 (不锈钢测杆)



订货号	A-5000-3551	A-5000-3552	A-5000-3553	A-5000-7606	A-5000-7630
A 测球直径 mm (in.)	1.0 (0.04)	2.0 (0.08)	3.0 (0.12)	4.0 (0.16)	5.0 (0.20)
B 长度 mm (in.)	21.0 (0.83)	21.0 (0.83)	21.0 (0.83)	21.0 (0.83)	21.0 (0.83)
C 测杆直径 mm (in.)	0.6 (0.03)	1.4 (0.06)	1.5 (0.06)	2.5 (0.10)	2.5 (0.10)
D EWL* mm (in.)	4.0 (0.16)	8.0 (0.32)	12.0 (0.48)	17.2 (0.68)	21.0 (0.83)
质量 (克)	1.0	1.0	1.0	1.3	1.5

21 mm系列

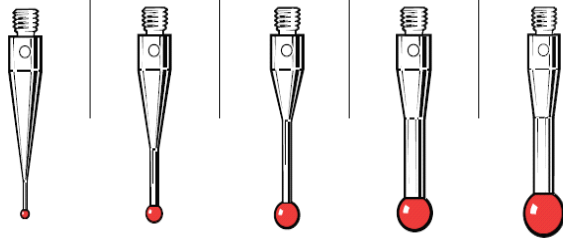

31 mm系列

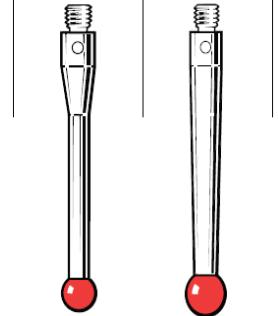

红宝石球测针 (碳化钨测杆)

订货号	A-5000-7632	A-5003-0050	A-5003-0054
A 测球直径 mm (in.)	0.5 (0.02)	1.5 (0.06)	2.5 (0.10)
B 长度 mm (in.)	21.0 (0.83)	21.0 (0.83)	21.0 (0.83)
C 测杆直径 mm (in.)	0.4 (0.02)	1.0 (0.04)	2.0 (0.08)
D EWL* mm (in.)	2.0 (0.08)	12.5 (0.50)	12.5 (0.50)
质量 (克)	1.0	0.8	1.3

21 mm系列

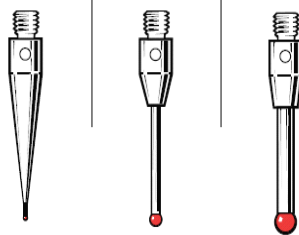

30 mm系列

A-5003-0051	A-5003-0052	A-5003-0055	A-5003-0057
1.5 (0.06)	2.0 (0.08)	2.5 (0.10)	3.0 (0.12)
30.0 (1.19)	30.0 (1.19)	30.0 (1.19)	30.0 (1.19)
1.0 (0.04)	1.5 (0.06)	2.0 (0.08)	2.0 (0.08)
22.5 (0.89)	22.5 (0.89)	22.5 (0.89)	22.5 (0.89)
0.93	1.32	1.81	1.83

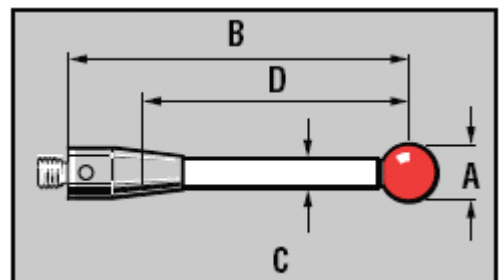
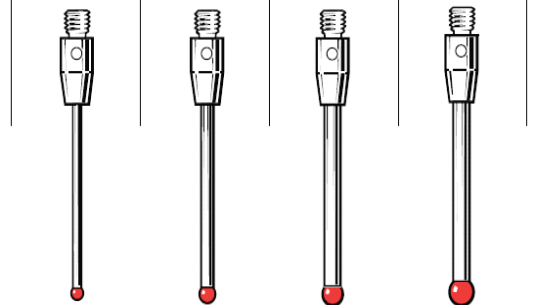



红宝石球测针（碳化钨测杆）

订货号	A-5003-0053	A-5003-0056	A-5003-0058	A-5003-0060	A-5003-0062
A 测球直径 mm (in.)	2.0 (0.08)	2.5 (0.10)	3.0 (0.12)	4.0 (0.16)	5.0 (0.20)
B 长度 mm (in.)	40.0 (1.58)	40.0 (1.58)	40.0 (1.58)	40.0 (1.58)	40.0 (1.58)
C 测杆直径 mm (in.)	1.5 (0.06)	2.0 (0.08)	2.0 (0.08)	2.0 (0.08)	2.5 (0.10)
D EWL* mm (in.)	32.5 (1.28)	32.5 (1.28)	32.5 (1.28)	36.0 (1.42)	40.0 (1.58)
质量 (克)	1.58	2.28	2.30	2.38	3.50

40 mm系列

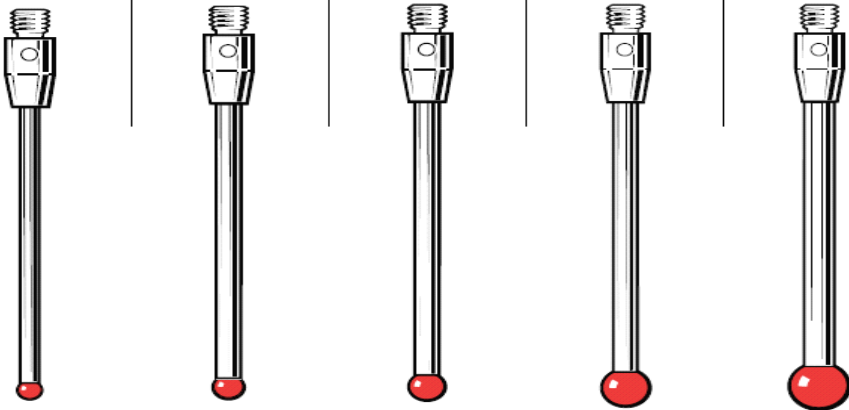

红宝石球测针（碳化钨测杆）

订货号	A-5003-0059	A-5003-0061	A-5003-0063
A 测球直径 mm (in.)	3.0 (0.12)	4.0 (0.16)	5.0 (0.20)
B 长度 mm (in.)	50.0 (1.97)	50.0 (1.97)	50.0 (1.97)
C 测杆直径 mm (in.)	2.0 (0.08)	2.0 (0.08)	2.5 (0.10)
D EWL* mm (in.)	42.5 (1.68)	46.0 (1.82)	50.0 (1.97)
质量 (克)	2.78	2.85	4.10

50 mm系列

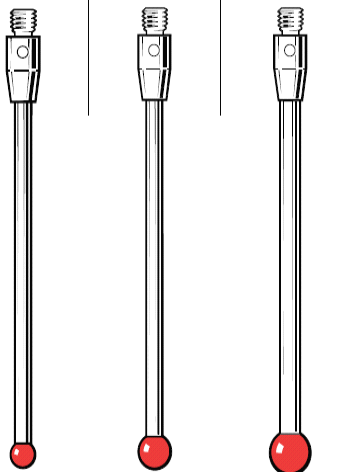

红宝石球测针（陶瓷测杆）

订货号	A-5003-0067	A-5003-0068	A-5003-00
A 测球直径 mm (in.)	3.0 (0.12)	4.0 (0.16)	5.0 (0.20)
B 长度 mm (in.)	50.0 (1.97)	50.0 (1.97)	50.0 (1.97)
C 测杆直径 mm (in.)	2.0 (0.08)	2.0 (0.08)	2.5 (0.10)
D EWL* mm (in.)	42.5 (1.68)	46.0 (1.82)	50.0 (1.97)
质量 (克)	1.17	1.24	1.33

50 mm系列

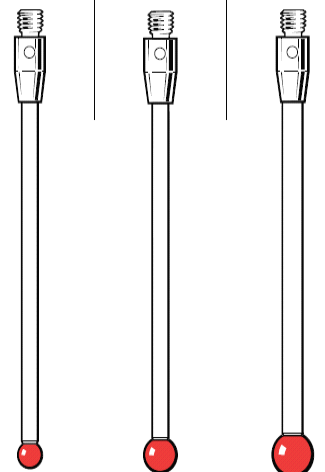

这些测针也可采用其他特殊材料的测球

* 有效工作长度

测针加长杆（不锈钢）

订货号	M-5000-7633	M-5000-3592	M-5000-3593
长度 mm (in.)	10.0 (0.40)	20.0 (0.79)	35.0 (1.38)
加长杆直径 mm (in.)	4.0 (0.16)	4.0 (0.16)	4.0 (0.16)
质量 (克)	0.9	1.6	2.9

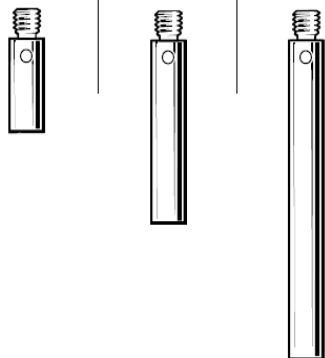

测针加长杆（碳纤维）

订货号	A-5003-4864	A-5003-4865
长度 mm (in.)	75.0 (2.96)	100.0 (3.94)
加长杆直径 mm (in.)	4.0 (0.16)	4.0 (0.16)
质量 (克)	2.53	3.02

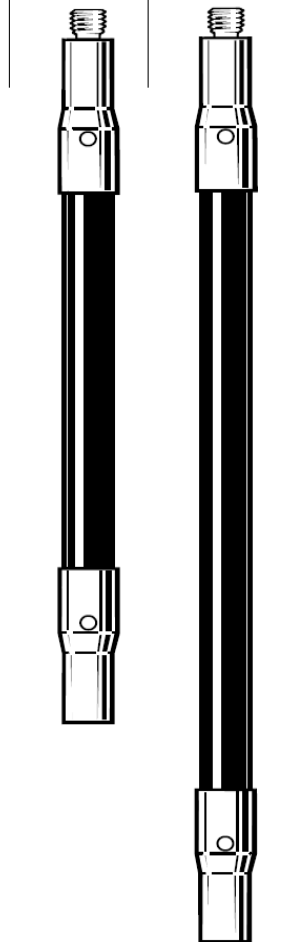

测针加长杆（陶瓷）

订货号	A-5003-0075
长度 mm (in.)	50.0 (1.97)
加长杆直径 mm (in.)	4.0 (0.16)
质量 (克)	2.95





M4螺纹测针系列

M4螺纹测针系列

5.0



OMP40紧凑型测头，适用于小型加工中心

Renishaw的检测系统经过精心设计，选用Renishaw的全系列测针时性能最佳。下列测头全部使用M4螺纹测针，但配备适当的转接件也可使用其他螺纹规格的测针。

- | CMM | 机床 | 数字化扫描系统 | | |
|---------|-------|---------|----------|-----------|
| • TP7 | • MP1 | • MP10 | • MP16 | • Cyclone |
| • SP600 | • MP3 | • MP11 | • MP10E | |
| • TP800 | • MP4 | • MP12 | • MP700E | |
| | • MP6 | • MP700 | • OMP40 | |
| | • MP7 | • LP2 | • RMP60 | |
| | • MP8 | • TS27R | • RP3 | |
| | • MP9 | • MP18 | • OMP60 | |

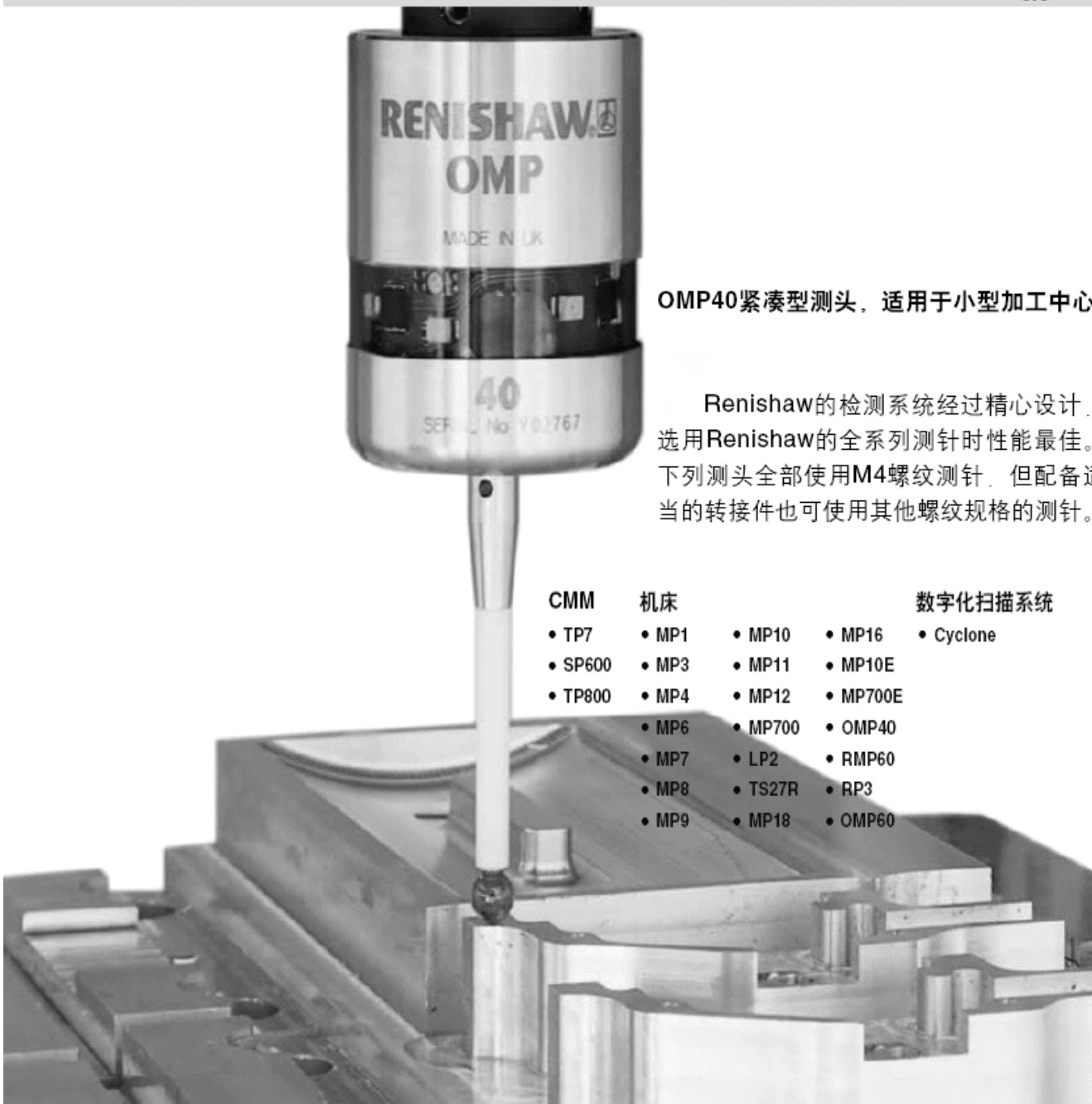

红宝石球测针

订货号	A-5000-7521 不锈钢	A-5003-0235 陶瓷	*A-5003-1436 碳纤维	A-5000-3709 陶瓷	A-5000-7795 陶瓷
A 测球直径 mm (in.)	5.0 (0.20)	5.0 (0.20)	6.0 (0.24)	6.0 (0.24)	8.0 (0.32)
B 长度 mm (in.)	50.0 (1.97)	50.0 (1.97)	50.0 (1.97)	50.0 (1.97)	50.0 (1.97)
C 测杆直径mm (in.)	4.5 (0.18)	3.8 (0.15)	4.5 (0.18)	4.5 (0.18)	4.5 (0.18)
D EWL* mm (in.)	35.0 (1.38)	34.0 (1.34)	36.0 (1.42)	36.0 (1.42)	50.0 (1.97)
质量 (克)	5.8	5.0	4.1	4.8	5.4

50 mm系列

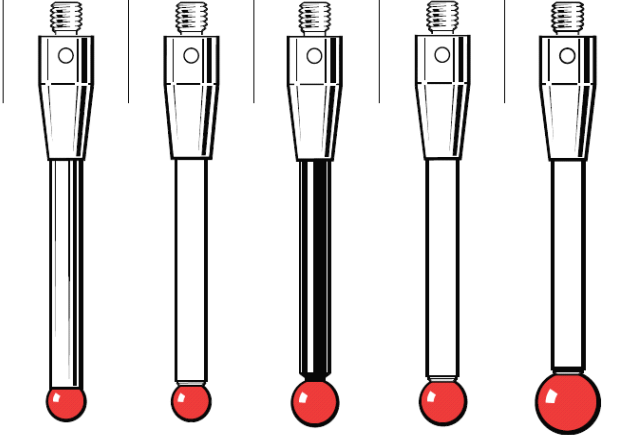

(碳化钨测杆)

订货号	A-5003-4797	A-5003-3680	A-5003-4799	A-5003-4800	A-5003-4801
A 测球直径 mm (in.)	2.0 (0.08)	3.0 (0.12)	4.0 (0.16)	5.0 (0.20)	6.0 (0.24)
B 长度 mm (in.)	50.0 (1.97)	50.0 (1.97)	50.0 (1.97)	50.0 (1.97)	50.0 (1.97)
C 测杆直径mm (in.)	1.5 (0.06)	2.0 (0.08)	2 (0.08)	2.5 (0.10)	2.5 (0.10)
D EWL* mm (in.)	40.0 (1.58)	38.0 (1.50)	38.0 (1.50)	36.0 (1.42)	36.0 (1.42)
质量 (克)	3.80	4.94	4.99	6.72	6.86

50 mm系列

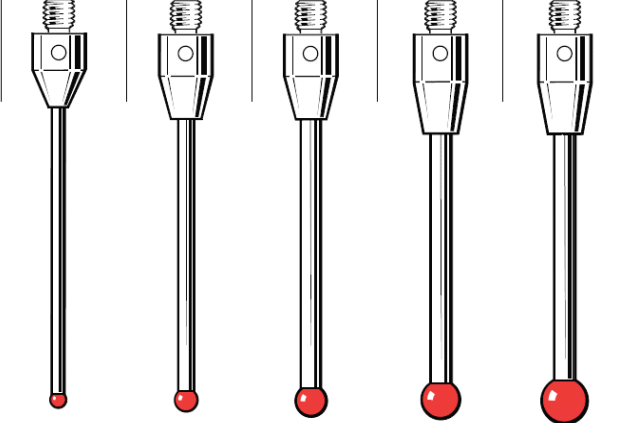

- 用于MP700
- 这些测针有内置破裂保护

(陶瓷测杆)

订货号	A-5003-0236	A-5003-2764	A-5003-4802
A 测球直径 mm (in.)	5.0 (0.20)	6.0 (0.24)	8.0 (0.32)
B 长度 mm (in.)	75.0 (2.96)	75.0 (2.96)	75.0 (2.96)
C 测杆直径mm (in.)	3.8 (0.15)	4.5 (0.18)	4.5 (0.18)
D EWL* mm (in.)	59.0 (2.33)	63.5 (2.51)	75.0 (2.96)
质量 (克)	5.63	5.64	6.20

75 mm系列

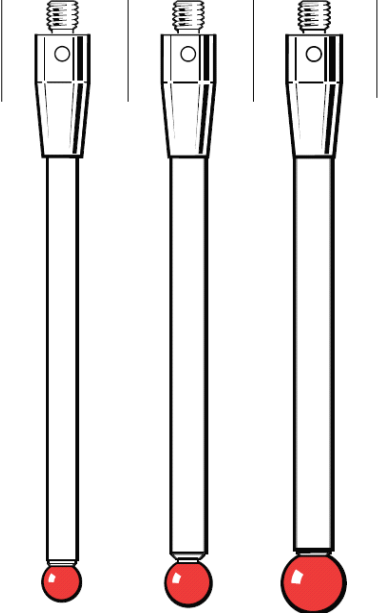

M5螺纹测针系列

M5螺纹测针系列

6.0

SP80是一种超精密Z轴嵌入式扫描测头

Renishaw的测头系统经过精心设计，选用其全系列测针时性能最佳。

下列测头全部使用M5螺纹测针，但配备适当的转接件也可使用其他螺纹规格的测针。

- SP80
- SP2
- SP2-1





红宝石球测针

订货号		A-5003-5204	A-5003-5205	A-5003-5206	A-5003-5207	A-5003-5208	A-5003-5209	A-5003-5210
		碳化钨	碳化钨	碳化钨	碳化钨	碳化钨	碳化钨	碳化钨
A	测球直径 mm (in.)	1.0 (0.04)	1.5 (0.06)	2.0 (0.08)	2.5 (0.10)	3.0 (0.12)	4.0 (0.16)	5.0 (0.20)
B	长度 mm (in.)	20.0 (0.79)	20.0 (0.79)	20.0 (0.79)	20.0 (0.79)	20.0 (0.79)	20.0 (0.79)	20.0 (0.79)
C	测杆直径 mm (in.)	0.7 (0.03)	1.0 (0.04)	1.0 (0.04)	1.5 (0.06)	2.0 (0.08)	2.0 (0.08)	3.0 (0.12)
D	EWL* mm (in.)	5.0 (0.20)	11.0 (0.44)	11.0 (0.44)	11.0 (0.44)	11.0 (0.44)	11.0 (0.44)	11.0 (0.44)
	质量 (克)	6.52	4.68	4.70	4.84	5.12	5.19	6.06
20 mm系列								

订货号		A-5003-5214	A-5003-5215	A-5003-5216	A-5003-5217	A-5003-5218	A-5003-5219	A-5003-5220
		碳化钨	碳化钨	碳化钨	碳化钨	碳化钨	碳化钨	碳化钨
A	测球直径 mm (in.)	1.0 (0.04)	1.5 (0.06)	2.0 (0.08)	2.5 (0.10)	3.0 (0.12)	4.0 (0.16)	5.0 (0.20)
B	长度 mm (in.)	30.0 (1.19)	30.0 (1.19)	30.0 (1.19)	30.0 (1.19)	30.0 (1.19)	30.0 (1.19)	30.0 (1.19)
C	测杆直径 mm (in.)	0.7 (0.03)	1.0 (0.04)	1.0 (0.04)	1.5 (0.06)	2.0 (0.08)	2.0 (0.08)	3.0 (0.12)
D	EWL* mm (in.)	5.0 (0.20)	12.0 (0.48)	21.0 (0.83)	21.0 (0.83)	21.0 (0.83)	21.0 (0.83)	21.0 (0.83)
	质量 (克)	9.01	7.28	4.81	5.14	5.58	5.64	7.10
30 mm系列								

订货号		A-5003-5221	A-5003-5222	A-5003-5223	A-5003-5224
		碳化钨	碳化钨	碳化钨	碳化钨
A	测球直径 mm (in.)	1.5 (0.06)	2.0 (0.08)	2.5 (0.10)	3.0 (0.12)
B	长度 mm (in.)	40.0 (1.58)	40.0 (1.58)	40.0 (1.58)	40.0 (1.58)
C	测杆直径 mm (in.)	1.0 (0.04)	1.0 (0.04)	1.5 (0.06)	2.0 (0.08)
D	EWL* mm (in.)	20.0 (0.79)	31.0 (1.23)	31.0 (1.23)	31.0 (1.23)
	质量 (克)	7.39	4.93	5.40	6.04
40 mm系列					