

1. SCOPE

This specification is applied to the ceramic resonator in IC oscillation circuit.

2. PART NUMBER

IFR40P0T0SE22

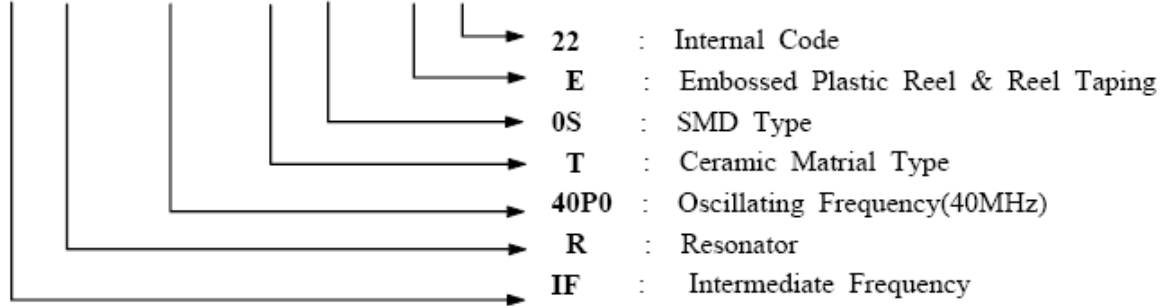

3. ELECTRICAL CHARACTERISTICS

The MHz ceramic resonator must meet the following performance when tested in the circuit indicated in figure 1 and figure 2.

- Measuring Condition : Temperature (+15 ~ 35℃), Humidity (45 ~85%RH)

ITEM	SPECIFICATION
Oscillation Frequency	40.00 MHz
Initial Tolerance	within $\pm 0.5\%$
Resonant Impedance	50 Ω max.
Built-in Load Capacitance	8pF $\pm 20\%$ max.
Insulation Resistance	500 M Ω min. (Applied D.C.10V)
Withstanding Voltage	D.C. 100V, 5 seconds max.
Rated Working Voltage (1) D.C. Voltage (2) A.C. Voltage	D.C. 6V 15Vp-p
Temperature Stability · Operating Temperature · Storage Temperature	$\pm 0.2\%$ max. (from initial value) -20℃ ~ +80℃ -40℃ ~ +85℃
Aging (10 years)	$\pm 0.1\%$ max. (from initial value)

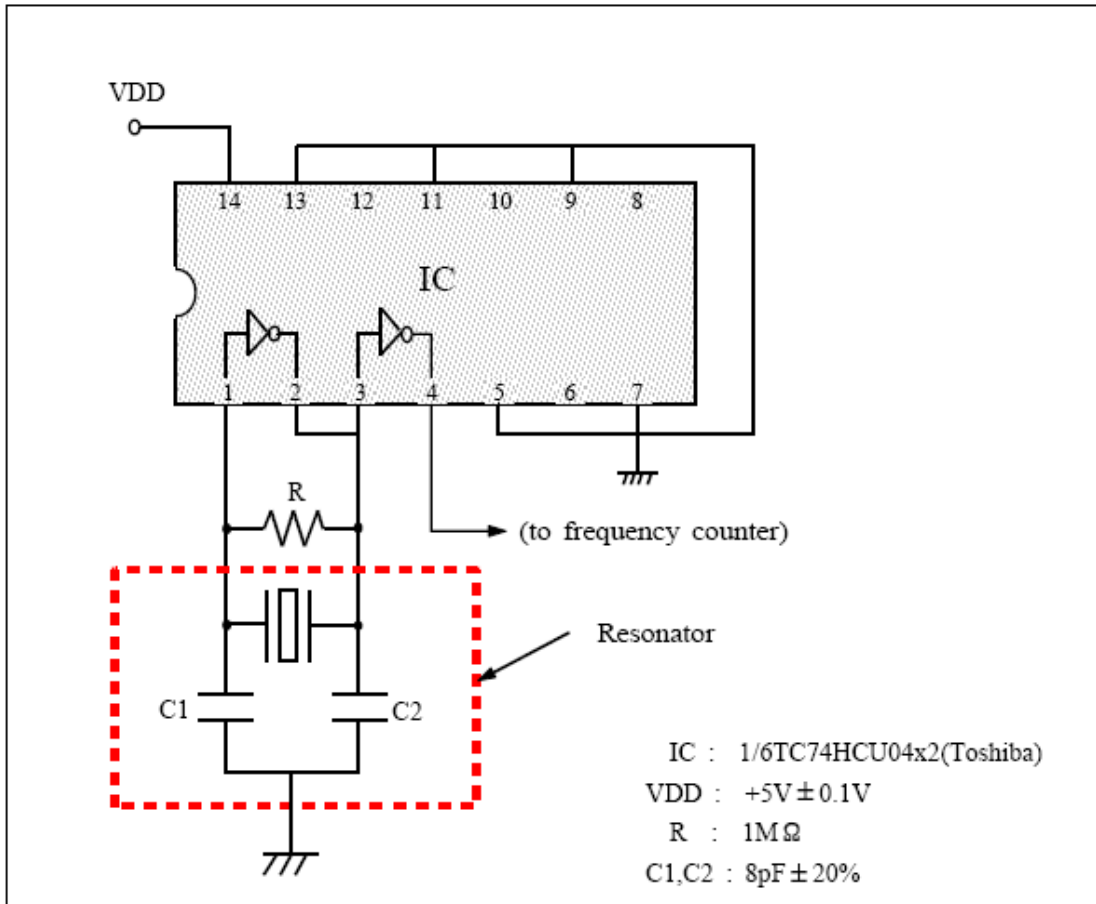

Figure 1. Test Circuit for Oscillating Frequency

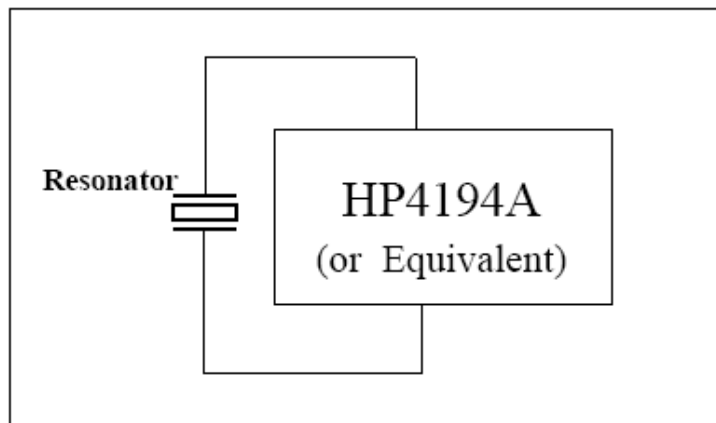
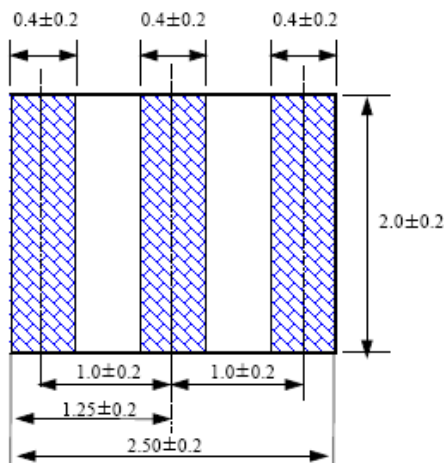
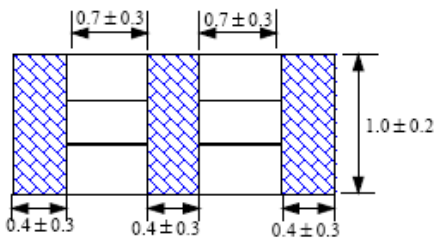
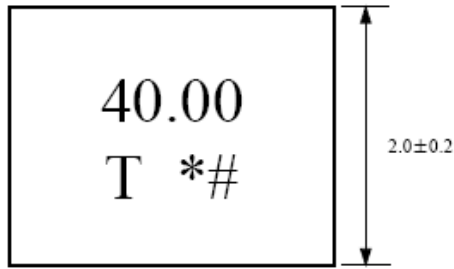

Figure 2. Measurement for Resonant Impedance

4. DIMENSIONS & STRUCTURE

● Marking



● PCB Soldering Land Dimensions

(Unit : mm)

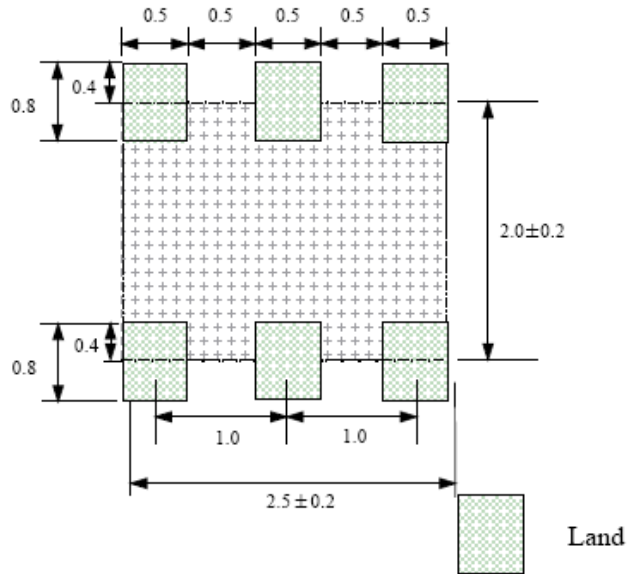

*# Internal Management Code

* : Monthly Code, # : Weekly Code

		Monthly Code											
Year	Month	1	2	3	4	5	6	7	8	9	10	11	12
2004		n	p	q	r	s	t	u	v	w	x	y	z
2005		A	B	C	D	E	F	G	H	J	K	L	M
2006		N	P	Q	R	S	T	U	V	W	X	Y	Z
2007		a	b	c	d	e	f	g	h	j	k	l	m

Weekly Code	
Weekly	Code
1	1
2	2
3	3
4	4
5	5

5. ENVIRONMENTAL & PHYSICAL CHARACTERISTICS

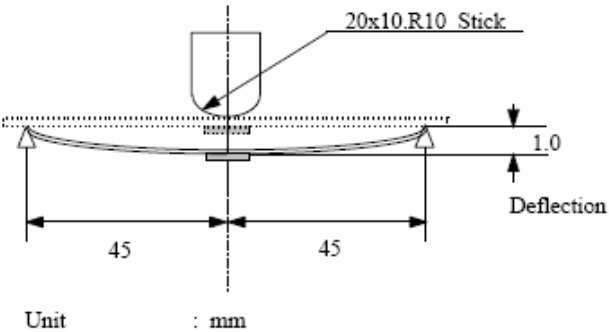
ITEM	CONDITION & REQUIREMENT
5-1. Storage in High Temp.	After being placed in a chamber with $+85 \pm 2 \text{ }^\circ\text{C}$ for 500 hours and then being placed in natural condition for 2 hour, then measure. <i>⇒ To be satisfied Table 1.</i>
5-2. Storage in Low Temp.	After being placed in a chamber with $-55 \pm 2 \text{ }^\circ\text{C}$ for 500 hours and then being placed in natural condition for 2 hour, then measure. <i>⇒ To be satisfied Table 1.</i>
5-3. Humidity	After being placed in a chamber within $+90$ to 95% R. H. at $+60 \pm 2 \text{ }^\circ\text{C}$ for 500 hours and then being placed in natural condition for 2 hour, then measure. <i>⇒ To be satisfied Table 1.</i>
5-4. Heat Shock	After being kept at room temperature, the resonator shall be placed at temperature of $-55 \text{ }^\circ\text{C}$. After 30 minutes at this temperature resonator shall be immediately placed at temperature of $+85 \text{ }^\circ\text{C}$. After 30 minutes at this temperature resonator shall be returned to $-55 \text{ }^\circ\text{C}$ again. After five above cycles, the resonator shall be returned to room temperature for at least 2 hour, then measure. <i>⇒ To be satisfied Table 1.</i>
5-5. Random Drop	Resonator shall be measured after 3 times random drops from the height of 1 m on wooden floor. <i>⇒ No visible damage and the measured values shall meet Table 1.</i>
5-6. Vibration Test	Resonator shall be measured after being applied vibration of amplitude to 1.5mm with 10 to 55Hz band of vibration frequency to each of a perpendicular directions for 2 hours. <i>⇒ No visible damage and the measured values shall meet Table 1.</i>
5-7. Bending Strength PCB	Resonator is soldered onto the center of PCB which is laid on the 2 small supporters spaced 90mm. PCB deflected to 1mm below from horizontal level by the pressing force with 20x10.R10 stick. The force is supplied for 1 second, 5 times repeatedly. Velocity of pole for press : 0.5mm/sec.  <i>⇒ No visible damage and the measured values shall meet Table 1.</i>

6. PACKAGING STANDARD

The products should be packaged for protecting from the accident which could be caused during transportation or preservation, and part name, quantity and inspection lot No. shall be given to the each minimum packing unit.

Note) 1 Tray contains 3,000 pcs Resonator.

WEIGHT : 0.04 g/pcs

◎ Reel

P/N	:(Part number)
Lot No	:
Quantity	: 3,000 pcs
Date	:

LOT No.: \diamond \diamond \diamond \diamond - \diamond \diamond \diamond \diamond - \diamond \diamond \diamond \diamond
 type ← Freq.(MHz) Materials Year&Month

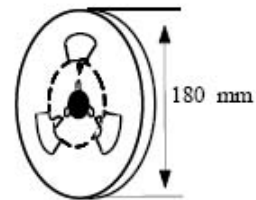

◎ Inner Box

P/N	:(Part number)
Quantity	: 6,000(2 reel)
Date	:

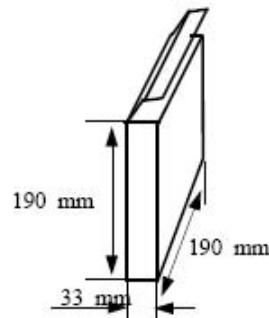

◎ Outer Box

Talk No	:
Talk P/N: (Part Name)	:
P/O No	:
Vendor	:
Quantity	: 60,000 pcs

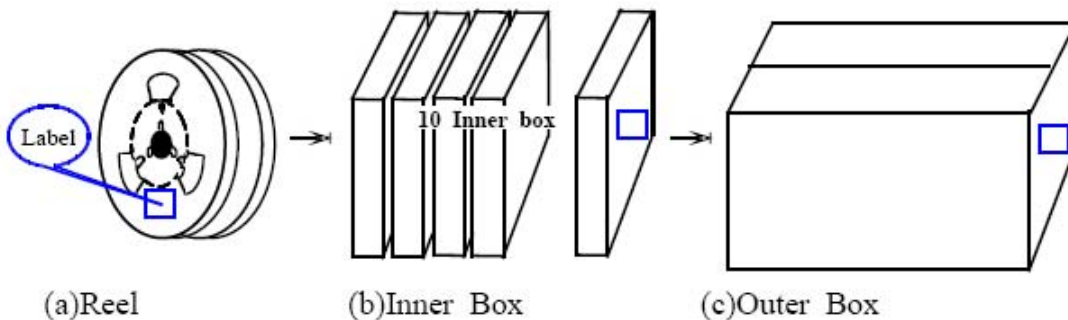
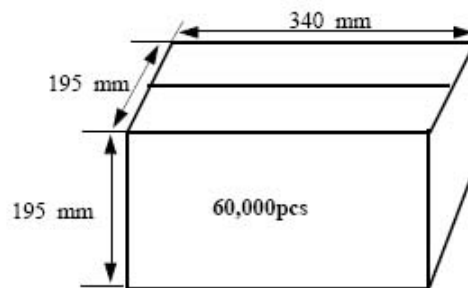

7. CAUTIONS FOR USE

- 7-1. Resonator might be damaged when an excess stress is applied.
- 7-2. Cleaning or washing of the component is not acceptable due to non sealed construction. Cleaning conditions, such as kinds of cleaning solvents, immersion time and temperatures etc, after soldering shall be checked by experiments before production.
- 7-3. Conformal coating of the component is acceptable. However, the resin material, curing temperature, and other process conditions should be evaluated to confirm stable electrical characteristics are maintained.
- 7-4. Irregular or stop oscillation may occur under unmatched circuit conditions. And it shall be noted that oscillating frequencies of the Ceramics Resonator may drift depending on IC applied (the type names, the manufacturer) and capacitance of external capacitors(C1,C2) and the circuit design in figure 1.

8. LIMITATION FOR USAGE

- 8-1. The component is manufactured and promoted to be used in general electronic of AV, home appliance, communication, measurement equipments and machine tools.
- 8-2. Contact us before using our products for the following applications.
 - 1) Aircraft equipment
 - 2) Aerospace equipment
 - 3) Undersea equipment
 - 4) Medical equipment
 - 5) Transportation equipment
 - 6) Traffic signal equipment
 - 7) Disaster prevention/Crime prevention equipment
 - 8) Data-processing equipment
 - 9) Applications of similar complexity or with reliability requirements comparable to the applications listed in the above.

These applications requires especially high reliability in order to prevent defects which might directly cause damage to other party's life, body or property.

9. NOTICE

- 9-1. This specification mentions the quality of the component as a single unit. Insure the component is thoroughly evaluated in your application circuit.
- 9-2. Be sure to provide an appropriate fail-safe function on your product to prevent a second damage that may be caused by an abnormality or failure related to our product.
- 9-3. Please do not use this component in any application that deviates from its intended use as noted within the specification.
- 9-4. Return one of this specification after your signature of acceptance. In case of no return within three months from submission date, this specification should be treated as accepted.

■ DIMENSIONS OF CARRIER TAPE

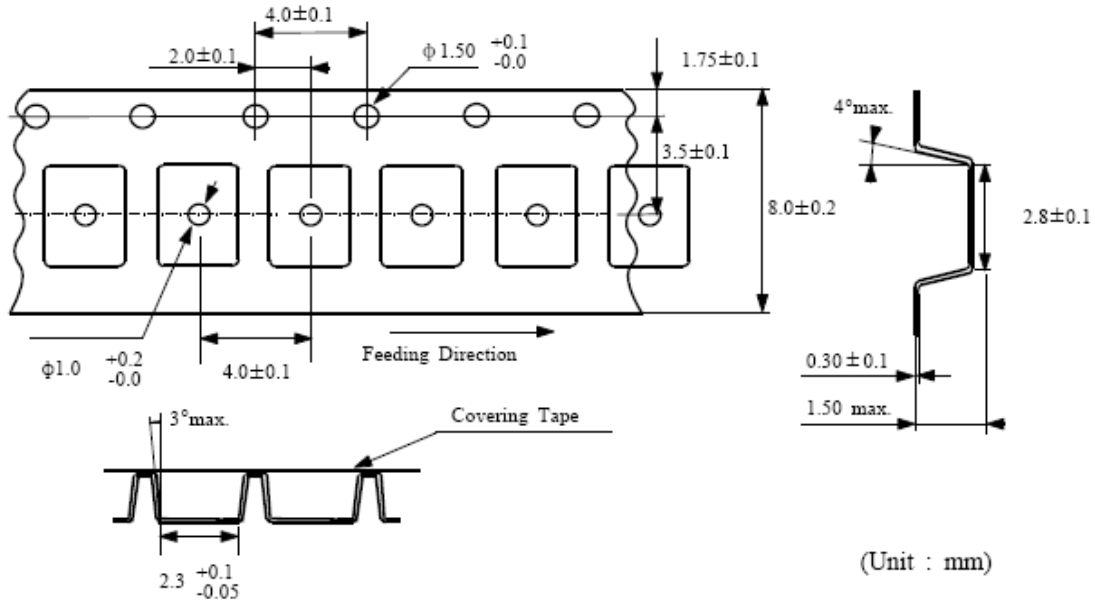

■ DIMENSIONS OF TAPING REEL

