

Technical Data Sheet
Photocoupler**EL357****Features:**

- Current transfer ratio
(CTR:MIN.50% at $I_F = 5\text{mA}$, $V_{CE} = 5\text{V}$)
- Isolation voltage between input and output
(E357: $V_{iso} = 3750\text{ V}_{rms}$)
- Subminiature type
(The volume is small than that of conventional DIP type by as far as 30%)
- Mini-flat package
EL357:1-channel type
- Pb free
- The product itself will remain within RoHS compliant version.

**Description**

The EL357 contains a gallium arsenic infrared emitting diode optically coupled to a phototransistor. It is packaged in a 4-pin SMD package

Applications

- Hybrid substrates that require high density mounting
- Programmable controllers
- System appliances, measuring instruments
- Telecommunication
- Electric home appliances, such as fan heaters, etc.
- Signal transmission between circuits of different potentials and impedances

Device Selection Guide

Part No.	Chip Material	
	IR	PT
EL357	GaAs	Silicon

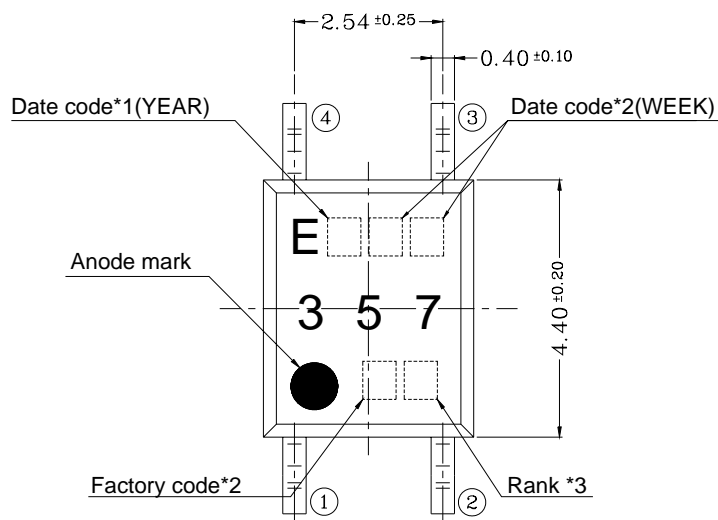
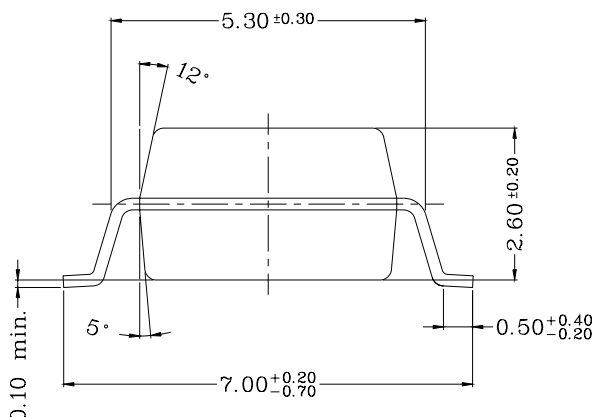
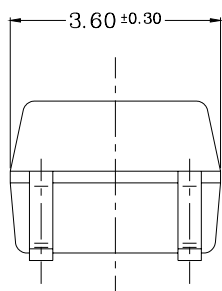
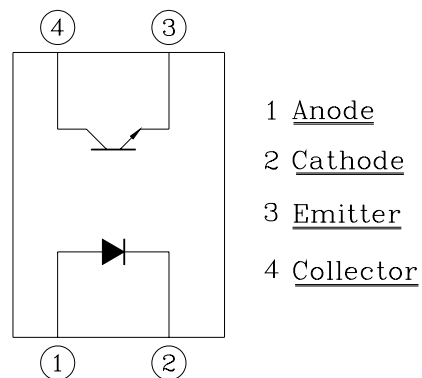
Technical Data Sheet
Photocoupler
EL357
Package Dimensions

PIN NO. AND INTERNAL CONNECTION DIAGRAM

Notes:

1. Rank shall be or shall not be marked
2. Factory code shall be marked (T: Taiwan / C: China)
3. Year date code
4. 2-digit work week
5. All dimensions are in millimeters
6. Specifications are subject to change without notice

Technical Data Sheet
Photocoupler
EL357
Absolute Maximum Ratings (Ta=25°C)

Parameter		Symbol	Rating	Unit
Input	Forward Current	I _F	50	mA
	Reverse Voltage	V _R	6	V
	<i>Power Dissipation</i>	P	70	mW
Output	Collector Power Dissipation	P _C	150	mW
	Collector Current	I _C	50	mA
	Collector-Emitter Voltage	V _{CEO}	35	V
	Emitter-Collector Voltage	V _{ECO}	6	V
Total Power Dissipation		P _{tot}	200	mW
* ¹ Isolation Voltage		V _{iso}	3750	V rms
Operating Temperature		T _{opr}	-55~+100	°C
Storage Temperature		T _{stg}	-55~+125	°C
* ² Soldering Temperature		T _{sol}	260	°C

*¹ AC for 1 minute, R.H= 40~ 60%RH

-Isolation voltage shall be measured using the following method.

- (1) Short between anode and cathode on the primary side and between collector, emitter and base on the secondary side.
- (2) The isolation voltage tester with zero-cross circuit shall be used.
- (3) The waveform of applied voltage shall be a sine wave

*² For 10 seconds

Technical Data Sheet
Photocoupler
EL357
Electro-Optical Characteristics
(Ta=25°C)

Parameter		Symbol	Min.	Typ.	Max.	Unit	Condition
Input	Forward	V_F	-	1.2	1.4	V	$I_F=20\text{mA}$
	Reverse Current	I_R	-	-	10	μA	$V_R=4\text{V}$
	Terminal	C_t	-	30	250	pF	$V=0, f=1\text{kHz}$
Output	Collector Dark current	I_{CEO}	-	-	100	nA	$V_{CE}=20\text{V}$
	Collector-Emitter breakdown voltage	BV_{CEO}	35	-	-	V	$I_c=0.1\text{mA}$
Transfer Characteristics	Current Transfer ratio	CTR	50	-	600	%	$I_F=5\text{mA}, V_{CE}=5\text{V}$
	Collector-Emitter saturation voltage	$V_{CE(sat)}$	-	0.1	0.2	V	$I_F=20\text{mA}, I_c=1\text{mA}$
	Isolation resistance	R_{ISO}	5×10^{10}	10^{11}	-	Ω	DC500V, 40~60%R.H
	Floating capacitance	C_f	-	0.6	1.0	pF	$V=0, f=1\text{MHz}$
	Cut-off frequency	f_c	-	80	-	kHz	$V_{CE}=5\text{V}, I_c=2\text{mA}$ $R_L=100\Omega, -3\text{dB}$
	Rise time	t_r	-	4	18	μs	$V_{CE}=2\text{V}$ $I_c=2\text{mA}, R_L=100\Omega$
	Fall time	t_f	-	3	18	μs	

**Technical Data Sheet
Photocoupler**
EL357
Supplement
Rank Table of Current Transfer Ratio CTR

Model No.	Rank mark	CTR (%)	Condition
EL357		50 to 600	$I_F = 5 \text{ mA}$ $V_{CE} = 5 \text{ V}$ $T_a = 25^\circ\text{C}$
EL357	L	50 to 100	
EL357	A	80 to 160	
EL357	B	130 to 260	
EL357	C	200 to 400	
EL357	D	300 to 600	
EL357	Y	150 to 300	

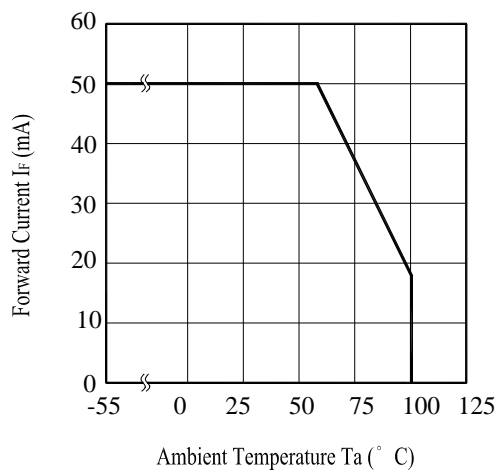
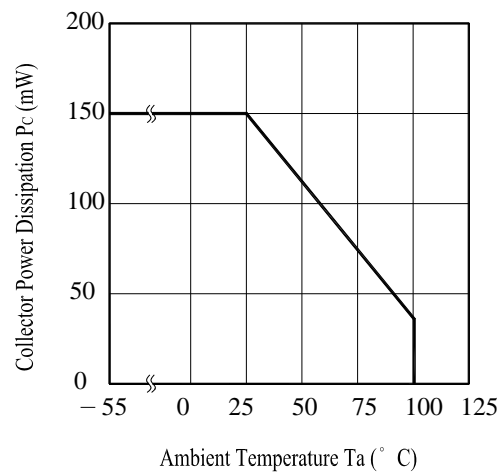
Fig. 1 Forward Current vs. Ambient Temperature

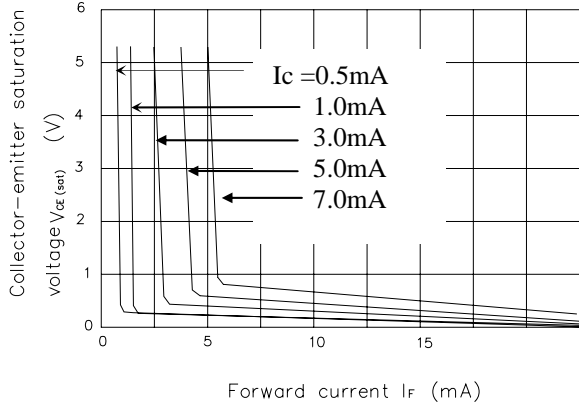
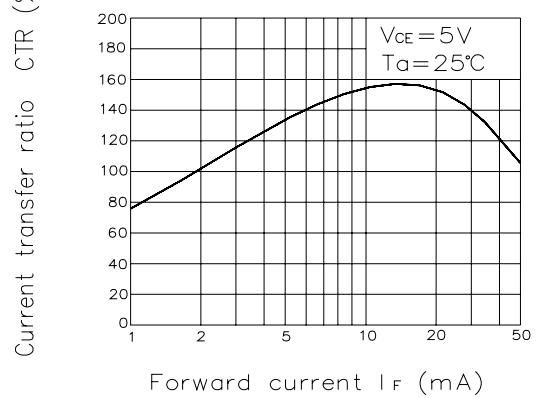
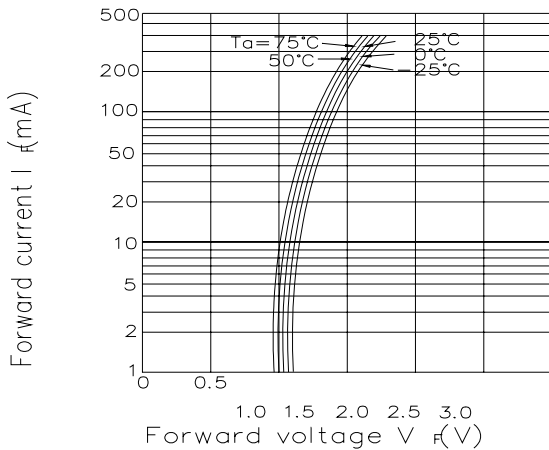
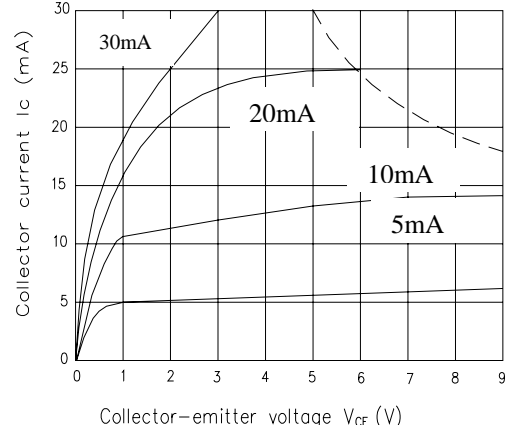
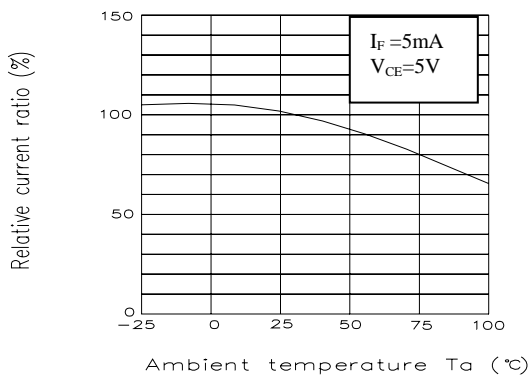
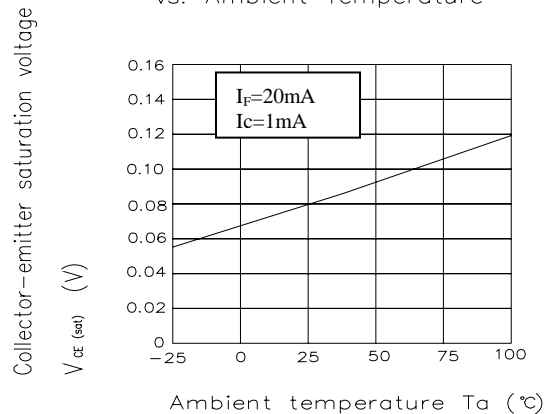
Fig. 2 Collector Power Dissipation vs. Ambient Temperature

Technical Data Sheet
Photocoupler
EL357
Fig. 3 Collector-emitter Saturation Voltage vs. Forward Current (Ta=25°C)

Fig.4 Current transfer Ratio vs. Forward Current

Fig.5 Forward Current vs. Forward Voltage

Fig.6 Collector Current vs. Collector-emitter Voltage (Ta=25°C)

Fig.7 Relative Current Transfer Ratio vs. Ambient Temperature

Fig.8 Collector-emitter Saturation Voltage vs. Ambient Temperature

Technical Data Sheet
Photocoupler
EL357

Fig.9

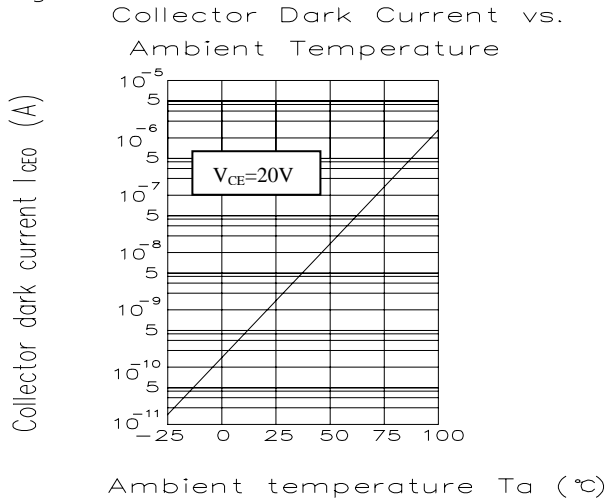

Fig.10

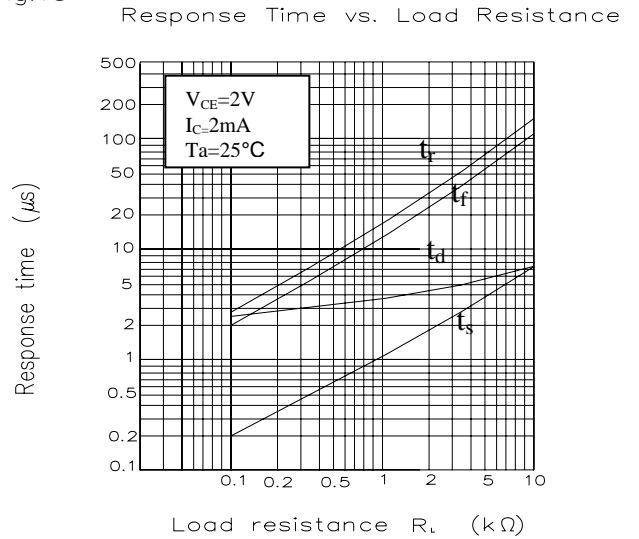
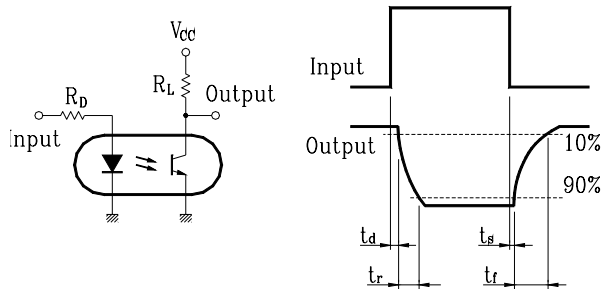
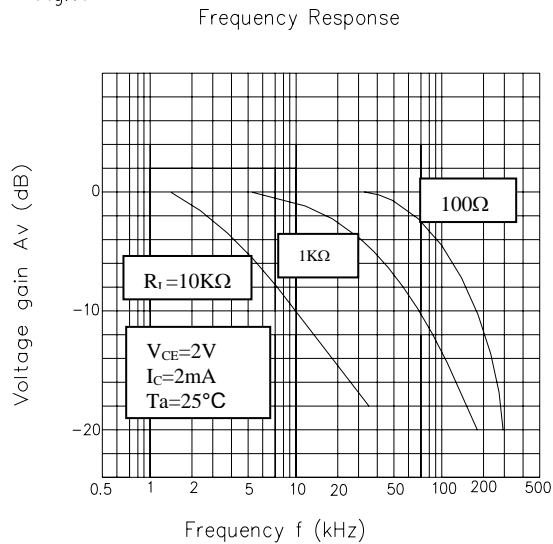

Fig.11





Technical Data Sheet

Photocoupler

EL357**RELIABILITY PLAN**

- The reliability of products shall be satisfied with items listed below.

Confidence level : 90 % , LTPD : 10 %

Classification	Test Item	Description & Condition	(Acc.) Sample	Failure Criteria	Reference Standard
Endurance test	Operation Life *	Ta = 25 ± 3°C IR: If = 50 mA Pt: Pc = 130 mW (Vf=1.4v) , 1000 hrs	0 / 22		MIL-S-750 : 1026 MIL-S-883 : 1005 JIS C 7021 : B-1
	High Temperature / High Humidity Reverse Bias (H3TRB)	Ta = 85 ± 3°C , Humi. = 85 % rh Pt: 80% * Vce (max rating) , 1000 hrs	0 / 22	CTR shift > 1.2 Vf > U* 1.0 Ir > U * 1.0 Vce(sat) > U*1.0	JIS C 7021 : B-11
	High Temperature Reverse Bias (HTRB)	Ta = 105 ± 3°C Pt: 100% * Vce (Max rating) , 1000 hrs	0 / 22	Bvceo < L*1.0 Bveco < L*1.0	JIS C 7021 : B-8
	Low Temperature Storage	Ta = -50 ± 3°C , 1000 hrs	0 / 22		JIS C 7021 : B-12
	High Temperature Storage	Ta = 125 ± 3°C , 1000 hrs	0 / 22	L :Low Spec.Limit	JIS C 7021 : B-10 MIL-S-883 : 1008
	Autoclave	P = 15 PSIG , Ta = 121 °C , Humi. = 100 % rh , 48 hrs	0 / 22	U : Up Spec.	JESD 22-A102-B
	Environmental Test	Temperature Cycling (Air to Air)	125°C ~ -55°C 30 ~ 30 min , 100 cycles	0 / 22	Limit
Thermal Shock (Liquid to Liquid)		125 ~ -55°C t (dwell) = 5 min t (trans.) = 10 sec , 100 cycles	0 / 22		MIL-S-202 : 107D MIL-S-750 : 1051 MIL-S-883 :1011
Solder Resistance		Ta = 260 ± 3°C t (dwell) = 10 ± 1 sec	0 / 22		MIL-S-750 : 2031 JIS C 7021 : A-1
Solder Ability		Ta = 230 ± 3°C t (dwell) = 5 ± 1 sec	0 / 22		MIL-S-883 : 2003 JIS C 7021 : A-2

**Technical Data Sheet
Photocoupler**

EL357

Taping Specification

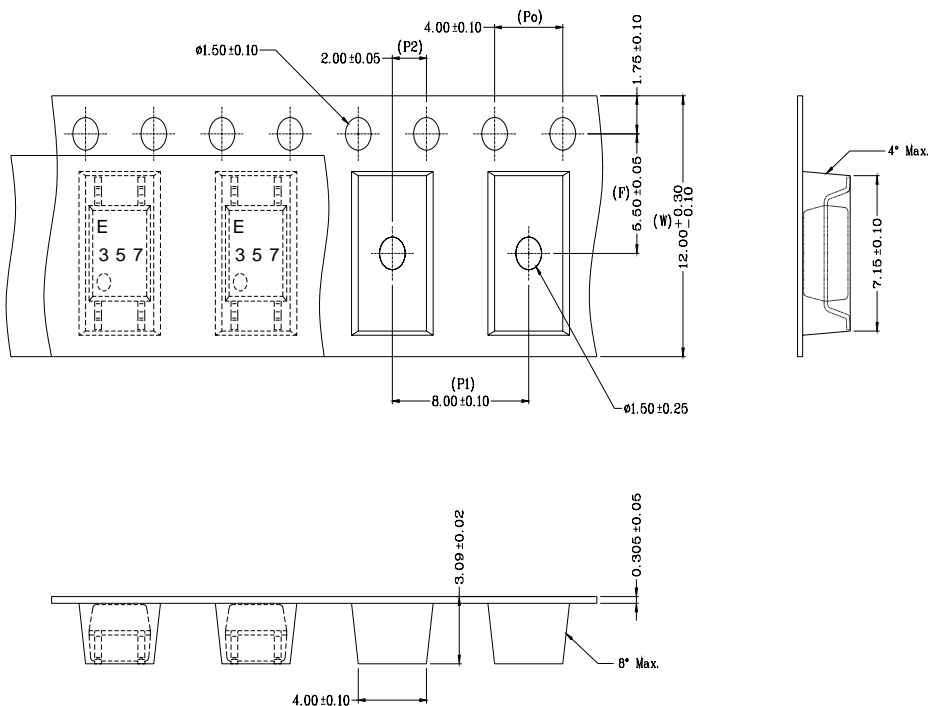

● **Packing Quantity**

1. 1,000 Pcs/ Per Reel
2. 3 Reels / Inner Carton
3. 10 Inner Cartons / Outside Carton

Label Form Specification

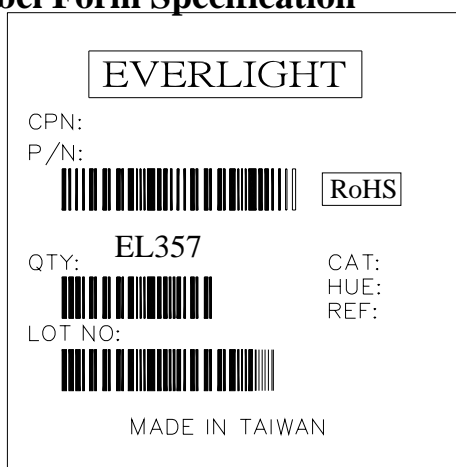

CPN: Customer's Production Number

P/N : Production Number

QTY: Packing Quantity

CAT: Ranks

HUE: Peak Wavelength

REF: Reference

LOT No: Lot Number

MADE IN TAIWAN: Production Place



**Technical Data Sheet
Photocoupler**

EL357

Notes

1. Above specification may be changed without notice. EVERLIGHT will reserve authority on material change for above specification.
2. When using this product, please observe the absolute maximum ratings and the instructions for using outlined in these specification sheets. EVERLIGHT assumes no responsibility for any damage resulting from use of the product which does not comply with the absolute maximum ratings and the instructions included in these specification sheets.
3. These specification sheets include materials protected under copyright of EVERLIGHT corporation. Please don't reproduce or cause anyone to reproduce them without EVERLIGHT's consent.

EVERLIGHT ELECTRONICS CO., LTD.
Office: No 25, Lane 76, Sec 3, Chung Yang Rd,
Tucheng, Taipei 236, Taiwan, R.O.C

Tel: 886-2-2267-2000, 2267-9936
Fax: 886-2267-6244, 2267-6189, 2267-6306
<http://www.everlight.com>