

PKR 2000A SI series
DC/DC converters, Input 18-36 V, Output 2 A/12 W

EN/LZT 146 352 R1B August 2006

© Ericsson Power Modules AB

Key Features

- Industry standard MacroDens™ footprint
47.8 x 28.1 x max height 8.0 mm (1.88 x 1.11 x max height 0.32 in.)
- Identical electrical design as the PKF series product
- High efficiency, typ. 85 % at 5.0 Vout full load
- 1500 Vdc input to output isolation
- Meets isolation requirements equivalent to basic insulation according to IEC/EN/UL 60950
- More than 6.0 million hours predicted MTBF at 40°C ambient temperature

General Characteristics

- Suited for narrow board pitch applications (15 mm/0.6 in)
- Input under voltage protection
- Over temperature protection
- Output short-circuit protection
- Over current protection
- Soft start
- Remote control
- Output voltage adjust function
- Highly automated manufacturing to ensure highest quality
- ISO 9001/14001 certified supplier

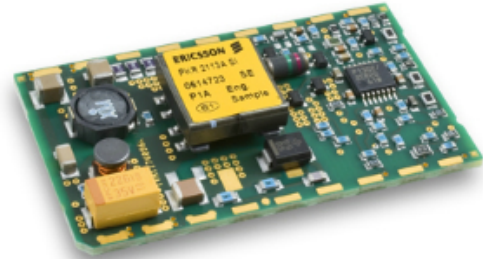

Safety Approvals



Design for Environment



Meets requirements in high-temperature lead-free soldering processes.

Contents

General Information	2
Safety Specification	3
Absolute Maximum Ratings	4
Product Program	Ordering No.	
3.3 V /2.0 A Electrical Specification	PKR 2610A SI 5
5.0 V /2.0 A Electrical Specification	PKR 2111A SI 8
12.0 V /1.0 A Electrical Specification	PKR 2113A SI 11
EMC Specification	14
Operating Information	16
Thermal Consideration	17
Connections	18
Mechanical Information	19
Soldering Information	21
Delivery Package Information	22
Product Qualification Specification	23

PKR 2000A SI series
DC/DC converters, Input 18-36 V, Output 2 A/12 W

EN/LZT 146 352 R1B August 2006

© Ericsson Power Modules AB

General Information

Ordering Information

See Contents for individual product ordering numbers.

Reliability

The Mean Time Between Failure (MTBF) is calculated at full output power and an operating ambient temperature (T_A) of +40°C, which is a typical condition in Information and Communication Technology (ICT) equipment. Different methods could be used to calculate the predicted MTBF and failure rate which may give different results. Ericsson Power Modules currently uses one method, Telcordia SR332.

Predicted MTBF for the series is:

- 6.0 million hours according to Telcordia SR332, issue 1, Black box technique.

Telcordia SR332 is a commonly used standard method intended for reliability calculations in ICT equipment. The parts count procedure used in this method was originally modelled on the methods from MIL-HDBK-217F, Reliability Predictions of Electronic Equipment. It assumes that no reliability data is available on the actual units and devices for which the predictions are to be made, i.e. all predictions are based on generic reliability parameters.

Compatibility with RoHS requirements

The products are compatible with the relevant clauses and requirements of the RoHS directive 2002/95/EC and have a maximum concentration value of 0.1% by weight in homogeneous materials for lead in other applications other than lead in solder, lead in high melting temperature type solder, lead in glass of electronics components, lead in electronic ceramic parts and lead as an alloying element in copper containing up to 4% lead by weight, mercury, hexavalent chromium, PBB and PBDE and of 0.01% by weight in homogeneous materials for cadmium.

Exemptions in the RoHS directive utilized in the products:

- Lead as an alloying element in copper alloy containing up to 4% lead by weight (used in connection pins made of Brass)
- Lead in high melting temperature type solder (used to solder the die in semiconductor packages)
- Lead in glass of electronics components and in electronic ceramic parts (e.g. fill material in chip resistors)
- Lead in solder for servers, storage and storage array systems, network infrastructure equipment for

switching, signaling, transmission as well as network management for telecommunication
(Note: the products are manufactured in lead-free soldering processes and the lead present in the solder is only located in the terminal plating finishes on some components)

Quality Statement

The products are designed and manufactured in an industrial environment where quality systems and methods like ISO 9000, 6 σ (sigma), and SPC are intensively in use to boost the continuous improvements strategy. Infant mortality or early failures in the products are screened out and they are subjected to an ATE-based final test. Conservative design rules, design reviews and product qualifications, plus the high competence of an engaged work force, contribute to the high quality of our products.

Warranty

Warranty period and conditions are defined in Ericsson Power Modules General Terms and Conditions of Sale.

Limitation of Liability

Ericsson Power Modules does not make any other warranties, expressed or implied including any warranty of merchantability or fitness for a particular purpose (including, but not limited to, use in life support applications, where malfunctions of product can cause injury to a person's health or life).

PKR 2000A SI series
DC/DC converters, Input 18-36 V, Output 2 A/12 W

EN/LZT 146 352 R1B August 2006

© Ericsson Power Modules AB

Safety Specification

General information

Ericsson Power Modules DC/DC converters and DC/DC regulators are designed in accordance with safety standards IEC/EN/UL60950, *Safety of Information Technology Equipment*.

IEC/EN/UL60950 contains requirements to prevent injury or damage due to the following hazards:

- Electrical shock
- Energy hazards
- Fire
- Mechanical and heat hazards
- Radiation hazards
- Chemical hazards

On-board DC-DC converters are defined as component power supplies. As components they cannot fully comply with the provisions of any Safety requirements without "Conditions of Acceptability". It is the responsibility of the installer to ensure that the final product housing these components complies with the requirements of all applicable Safety standards and Directives for the final product.

Component power supplies for general use should comply with the requirements in IEC60950, EN60950 and UL60950 "*Safety of information technology equipment*".

There are other more product related standards, e.g. IEEE802.3af "Ethernet LAN/MAN Data terminal equipment power", and ETS300132-2 "Power supply interface at the input to telecommunications equipment; part 2: DC", but all of these standards are based on IEC/EN/UL60950 with regards to safety.

Ericsson Power Modules DC/DC converters and DC/DC regulators are UL60950 recognized and certified in accordance with EN60950.

The flammability rating for all construction parts of the products meets requirements for V-0 class material according to IEC 60695-11-10.

The products should be installed in the end-use equipment, in accordance with the requirements of the ultimate application. Normally the output of the DC/DC converter is considered as SELV (Safety Extra Low Voltage) and the input source must be isolated by minimum Double or Reinforced Insulation from the primary circuit (AC mains) in accordance with IEC/EN/UL60950.

Isolated DC/DC converters

It is recommended that a slow blow fuse with a rating twice the maximum input current per selected product be used at the input of each DC/DC converter. If an input filter is used in the circuit the fuse should be placed in front of the input filter.

In the rare event of a component problem in the input filter or in the DC/DC converter that imposes a short circuit on the input source, this fuse will provide the following functions:

- Isolate the faulty DC/DC converter from the input power source so as not to affect the operation of other parts of the system.
- Protect the distribution wiring from excessive current and power loss thus preventing hazardous overheating.

The galvanic isolation is verified in an electric strength test. The test voltage (V_{iso}) between input and output is 1500 Vdc or 2250 Vdc for 60 seconds (refer to product specification).

Leakage current is less than 1 μ A at nominal input voltage.

24 V DC systems

The input voltage to the DC/DC converter is SELV (Safety Extra Low Voltage) and the output remains SELV under normal and abnormal operating conditions.

48 and 60 V DC systems

If the input voltage to Ericsson Power Modules DC/DC converter is 75 Vdc or less, then the output remains SELV (Safety Extra Low Voltage) under normal and abnormal operating conditions.

Single fault testing in the input power supply circuit should be performed with the DC/DC converter connected to demonstrate that the input voltage does not exceed 75 Vdc.

If the input power source circuit is a DC power system, the source may be treated as a TNV2 circuit and testing has demonstrated compliance with SELV limits and isolation requirements equivalent to Basic Insulation in accordance with IEC/EN/UL60950.

Non-isolated DC/DC regulators

The input voltage to the DC/DC regulator is SELV (Safety Extra Low Voltage) and the output remains SELV under normal and abnormal operating conditions.

PKR 2000A SI series
DC/DC converters, Input 18-36 V, Output 2 A/12 W

EN/LZT 146 352 R1B August 2006

© Ericsson Power Modules AB

Absolute Maximum Ratings

Characteristics		min	typ	max	Unit
T_{ref}	Operating Temperature (see Thermal Consideration section)	-45		+110	°C
T_s	Storage temperature	-55		+125	°C
V_I	Input voltage	-0.5		+40	V
V_{iso}	Isolation voltage (input to output test voltage)			1500	Vdc
V_{tr}	Input voltage transient (Tp 100 ms)			60	V
V_{RC}	Remote Control pin voltage (see Operating Information section)	Positive logic option		+16	V
V_{adj}	Adjust pin voltage (see Operating Information section)	-5		+40	V

Stress in excess of Absolute Maximum Ratings may cause permanent damage. Absolute Maximum Ratings, sometimes referred to as no destruction limits, are normally tested with one parameter at a time exceeding the limits of Output data or Electrical Characteristics. If exposed to stress above these limits, function and performance may degrade in an unspecified manner.

Fundamental Circuit Diagram

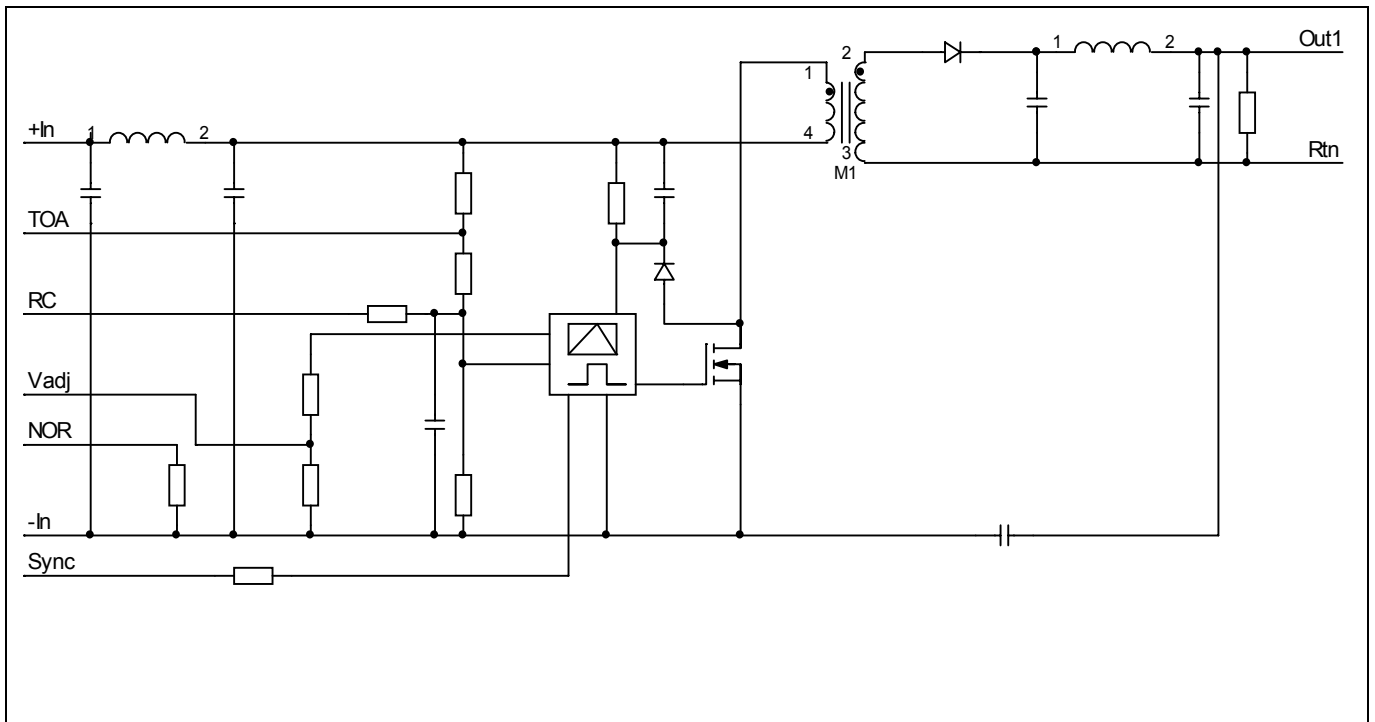

PKR 2000A SI series
 DC/DC converters, Input 18-36 V, Output 2 A/12 W

EN/LZT 146 352 R1B August 2006

© Ericsson Power Modules AB

3.3 V/2 A Electrical Specification
PKR 2610A SI
 $T_{ref} = -30$ to $+95^{\circ}\text{C}$, $V_I = 18$ to 36 V, unless otherwise specified under Conditions.

 Typical values given at: $T_{ref} = +25^{\circ}\text{C}$, $V_I = 27$ V, max I_O , unless otherwise specified under Conditions.

Characteristics		Conditions	min	typ	max	Unit
V_I	Input voltage range		18		36	V
V_{loff}	Turn-off input voltage	Decreasing input voltage	15	16		V
V_{lon}	Turn-on input voltage	Increasing input voltage		17.4	17.9	V
C_I	Internal input capacitance			2		μF
P_O	Output power	Output voltage initial setting	0		6.6	W
SVR	Supply voltage rejection (ac)	$f = 100$ Hz sine wave, 1 Vp-p		61		dB
η	Efficiency	50 % of max I_O		81		%
		max I_O		82		
		50 % of max I_O , $V_I = 24$ V		82		
		max I_O , $V_I = 24$ V		82		
P_d	Power Dissipation	max I_O		1.4	2	W
P_{li}	Input idling power	$I_O = 0$, $V_I = 27$ V		120		mW
P_{RC}	Input standby power	$V_I = 27$ V (turned off with RC)		25		mW
f_s	Switching frequency	10 -100% of max I_O	477	510	533	kHz

V_{oi}	Output voltage initial setting and accuracy	$T_{ref} = +25^{\circ}\text{C}$, $V_I = 27$ V, $I_O = 1$ A	3.27	3.30	3.33	V
	Output adjust range		1.8		3.8	V
V_O	Output voltage tolerance band	10-100% of max I_O	3.17		3.43	V
	Idling voltage	$I_O = 0$		3.6	4.6	V
	Line regulation	max I_O		6		mV
	Load regulation	$V_I = 27$ V, 10-100% of max I_O		70		mV
V_{tr}	Load transient voltage deviation	$V_I = 27$ V, Load step 25-75-25 % of max I_O , $di/dt = 1$ A/ μs		± 180		mV
t_{tr}	Load transient recovery time			100		μs
t_r	Ramp-up time (from 10–90 % of V_{Oj})	10-100% of max I_O	0.2	2.3	5	ms
t_s	Start-up time (from V_I connection to 90% of V_{Oj})		1	4.2	15	ms
I_O	Output current		0		2	A
I_{lim}	Current limit threshold	$V_O = 3$ V, $T_{ref} < \max T_{ref}$	2.2	2.7	3.5	A
I_{sc}	Short circuit current	$T_{ref} = 25^{\circ}\text{C}$		3		A
V_{Oac}	Output ripple & noise	Note 1, See ripple & noise section, max I_O , V_O .		6	50	mVp-p

Note 1: Output filter according to Ripple & Noise section

PKR 2000A SI series
DC/DC converters, Input 18-36 V, Output 2 A/12 W

EN/LZT 146 352 R1B August 2006

© Ericsson Power Modules AB

3.3 V/2 A Typical Characteristics

PKR 2610A SI

Efficiency

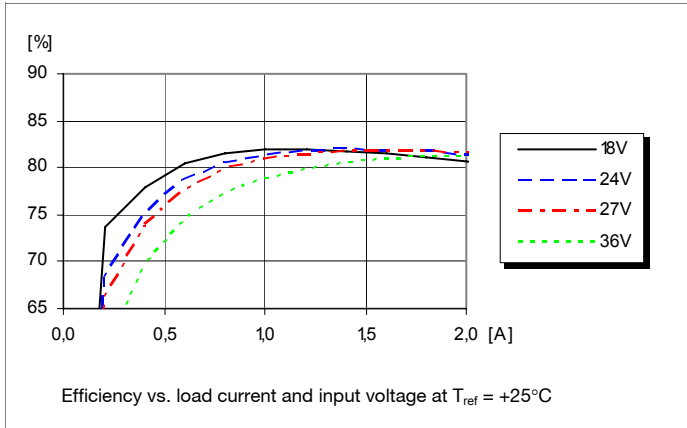

Power Dissipation

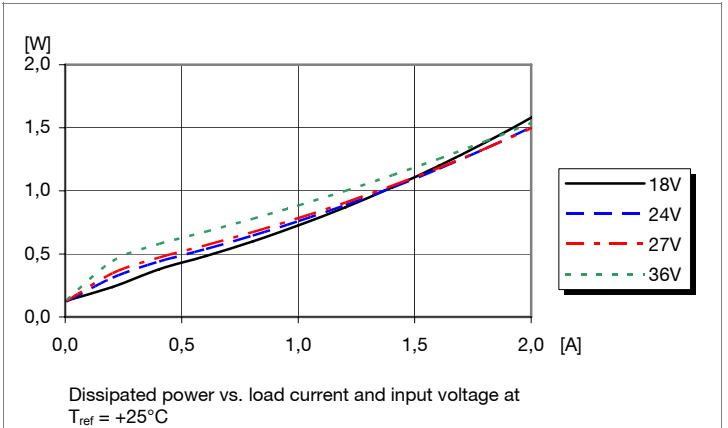

Output Current Derating

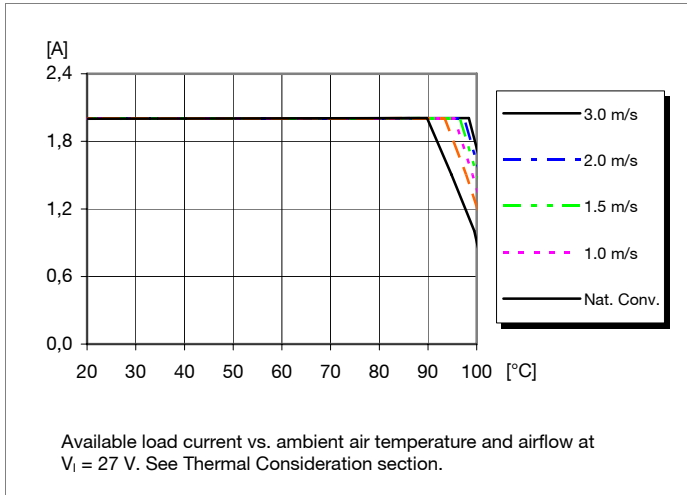

Thermal Resistance

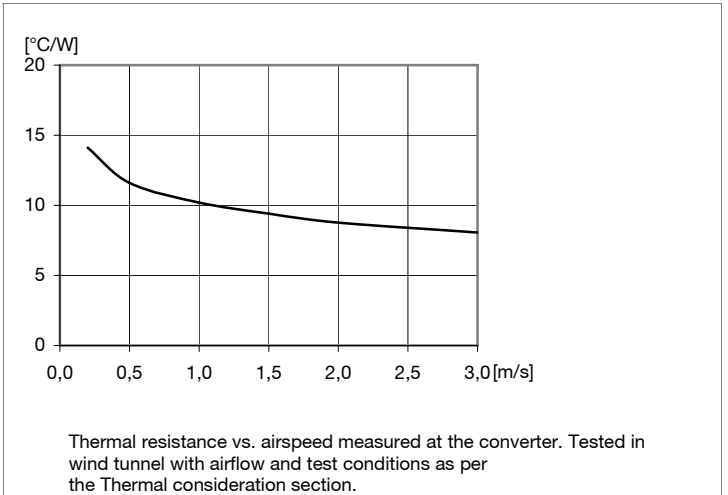

Output Characteristics

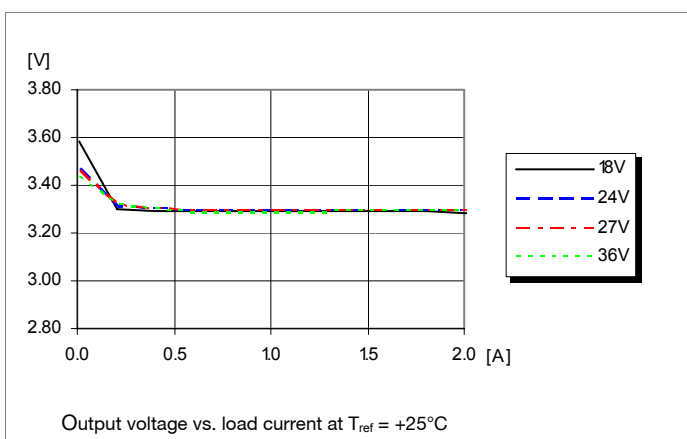

Current Limit Characteristics

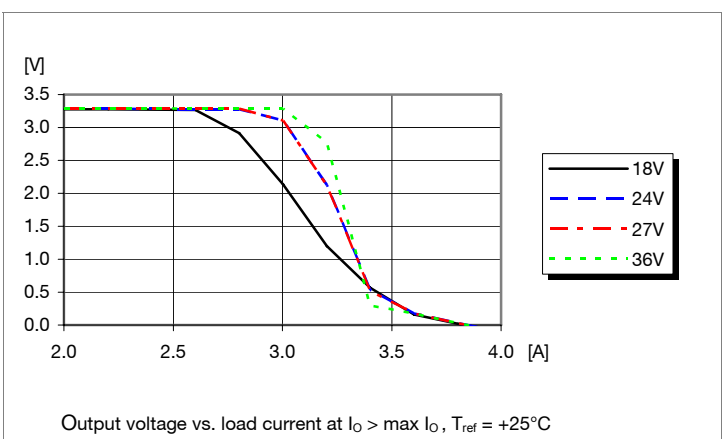

PKR 2000A SI series
DC/DC converters, Input 18-36 V, Output 2 A/12 W

EN/LZT 146 352 R1B August 2006

© Ericsson Power Modules AB

3.3 V/2 A Typical Characteristics

PKR 2610A SI

Start-up

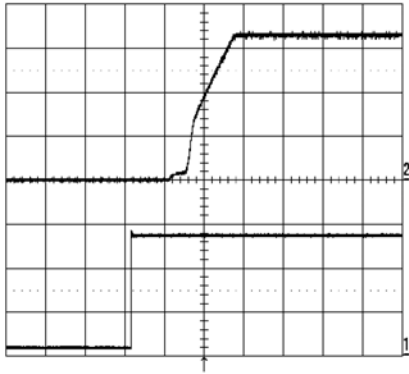

Start-up enabled by connecting V_i at:
 $T_{ref} = +25^\circ\text{C}$, $I_o = 2$ A resistive load,
 $V_i = 27$ V.

Top trace: output voltage (1 V/div.).
Bottom trace: input voltage (10 V/div.).
Time scale: 2 ms/div..

Shut-down

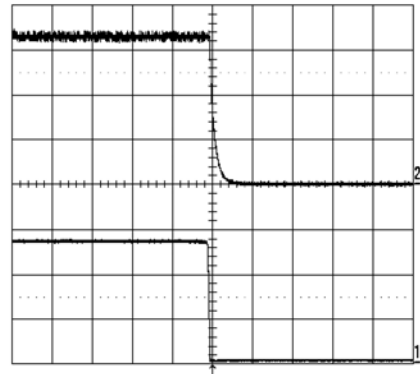

Shut-down enabled by disconnecting V_i at:
 $T_{ref} = +25^\circ\text{C}$, $I_o = 2$ A resistive load,
 $V_i = 27$ V

Top trace: output voltage (1 V/div.). Bottom trace:
input voltage (10 V/div.).
Time scale: 2 ms/div..

Output Ripple & Noise

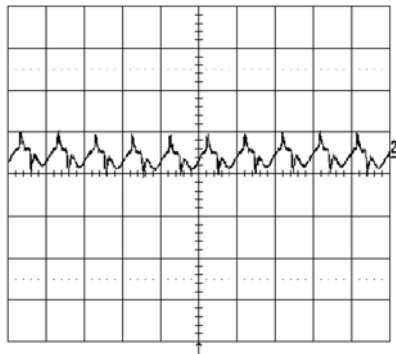

Output voltage ripple (5mV/div.) at:
 $T_{ref} = +25^\circ\text{C}$, $I_o = 2$ A resistive load,
 $V_i = 27$ V. Time scale: 2 μs /div.

See the filter in the Output ripple and noise
section (EMC Specification).

Output Load Transient Response

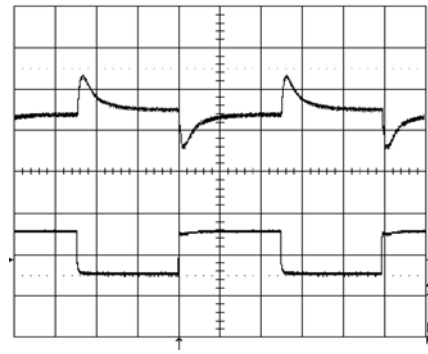

Output voltage response to load current
step-change (0.5-1.5-0.5 A) at:
 $T_{ref} = +25^\circ\text{C}$, $V_i = 27$ V.

Top trace: output voltage (200mV/div.).
Bottom trace: load current (1 A/div.).
Time scale: 0.2 ms/div.

Output Voltage Adjust (see operating information)

Passive trim

The resistor value for an adjusted output voltage is calculated by using the following equations:

Output Voltage Adjust Upwards, Increase:

$$R_{ou} = 3.18 \times (3.9 - V_o) / (V_o - V_o) \text{ k}\Omega$$

E.g. Increase 4% => $V_{out} = 3.43$ Vdc

$$3.18 \times (3.9 - 3.43) / (3.43 - 3.3) = 11.5 \text{ k}\Omega$$

Output Voltage Adjust Downwards, Decrease:

$$R_{od} = 17.2 \times (V_{oi} - V_o) / (V_o - 1.7) \text{ k}\Omega$$

E.g. Decrease 2% => $V_{out} = 3.23$ Vdc

$$17.2 \times (3.3 - 3.23) / (3.23 - 1.7) = 0.79 \text{ k}\Omega$$

PKR 2000A SI series DC/DC converters, Input 18-36 V, Output 2 A/12 W	EN/LZT 146 352 R1B August 2006
	© Ericsson Power Modules AB

5 V/2 A Electrical Specification
PKR 2111A SI
 $T_{ref} = -30$ to $+95^{\circ}\text{C}$, $V_I = 18$ to 36 V, unless otherwise specified under Conditions.

 Typical values given at: $T_{ref} = +25^{\circ}\text{C}$, $V_I = 27$ V, max I_O , unless otherwise specified under Conditions.

Characteristics		Conditions	min	typ	max	Unit
V_I	Input voltage range		18		36	V
V_{loff}	Turn-off input voltage	Decreasing input voltage	15	16		V
V_{lon}	Turn-on input voltage	Increasing input voltage		17.4	17.9	V
C_I	Internal input capacitance			2		μF
P_O	Output power	Output voltage initial setting	0		10	W
SVR	Supply voltage rejection (ac)	$f = 100$ Hz sine wave, 1 Vp-p		65		dB
η	Efficiency	50 % of max I_O		85		%
		max I_O		85		
		50 % of max I_O , $V_I = 24$ V		85		
		max I_O , $V_I = 24$ V		85		
P_d	Power Dissipation	max I_O		1.8	2.4	W
P_{li}	Input idling power	$I_O = 0$, $V_I = 27$ V		185		mW
P_{RC}	Input standby power	$V_I = 27$ V (turned off with RC)		25		mW
f_s	Switching frequency	10 -100% of max I_O	477	510	533	kHz

V_{Oi}	Output voltage initial setting and accuracy	$T_{ref} = +25^{\circ}\text{C}$, $V_I = 27$ V, $I_O = 1.5$ A	5.02	5.05	5.08	V
	Output adjust range		4.3		5.8	V
V_O	Output voltage tolerance band	10-100% of max I_O	4.85		5.25	V
	Idling voltage	$I_O = 0$	5.2	5.7	6.5	V
	Line regulation	max I_O		10		mV
	Load regulation	$V_I = 27$ V, 10-100% of max I_O		100		mV
V_{tr}	Load transient voltage deviation	$V_I = 27$ V, Load step 25-75-25 % of max I_O , $di/dt = 1$ A/ μs		± 200		mV
t_{tr}	Load transient recovery time			100		μs
t_r	Ramp-up time (from 10-90 % of V_{Oj})	10-100% of max I_O	0.2	2.5	5	ms
t_s	Start-up time (from V_I connection to 90% of V_{Oj})		1	5.5	15	ms
I_O	Output current		0		2	A
I_{lim}	Current limit threshold	$V_O = 4$ V, $T_{ref} < \max T_{ref}$	2.2	2.5	3.0	A
I_{sc}	Short circuit current	$T_{ref} = 25^{\circ}\text{C}$		3.3		A
V_{Oac}	Output ripple & noise	Note 1, See ripple & noise section, max I_O , V_O .		10	50	mVp-p

Note 1: Output filter according to Ripple & Noise section

PKR 2000A SI series
DC/DC converters, Input 18-36 V, Output 2 A/12 V

EN/LZT 146 352 R1B August 2006

© Ericsson Power Modules AB

5 V/2 A Typical Characteristics

PKR 2111A SI

Efficiency

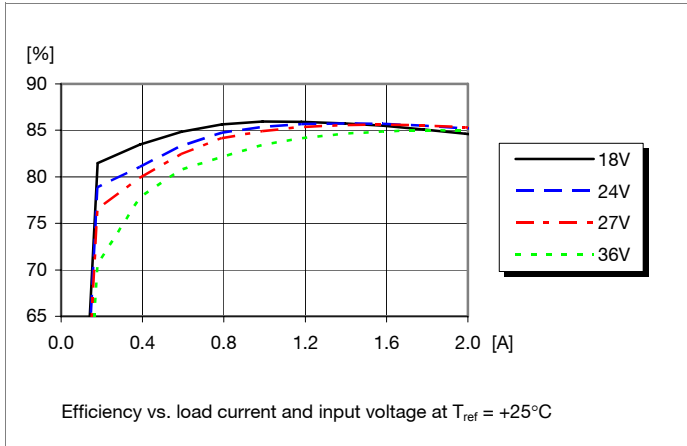

Power Dissipation

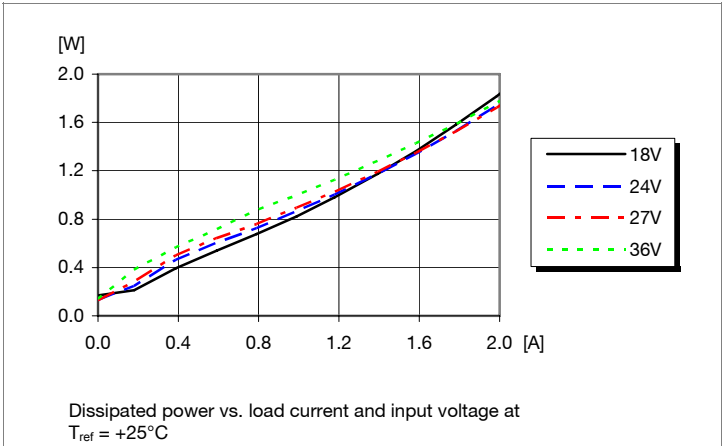

Output Current Derating

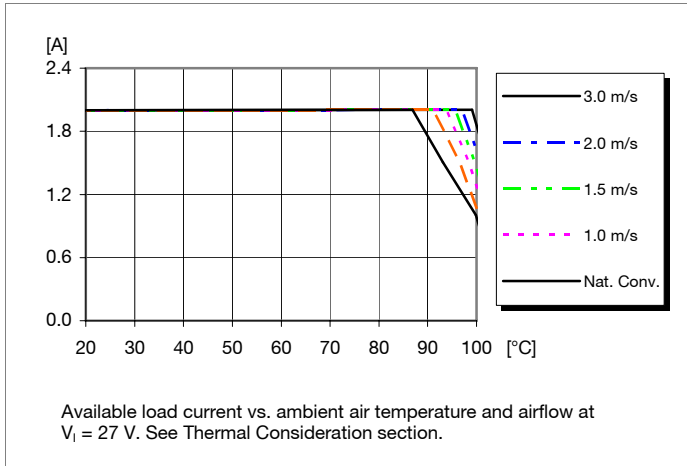

Thermal Resistance

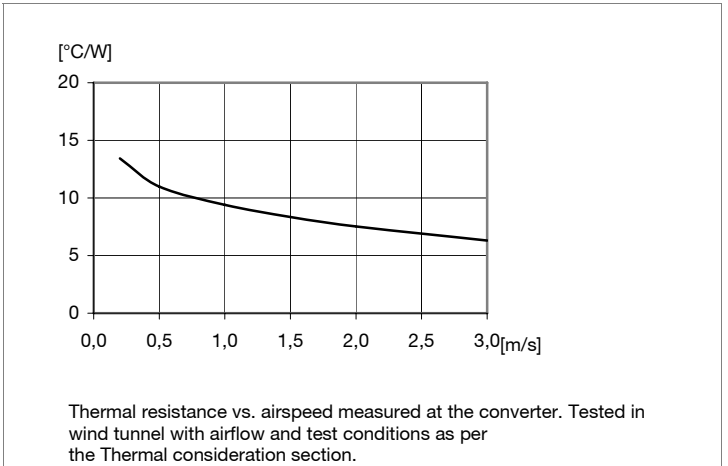

Output Characteristics

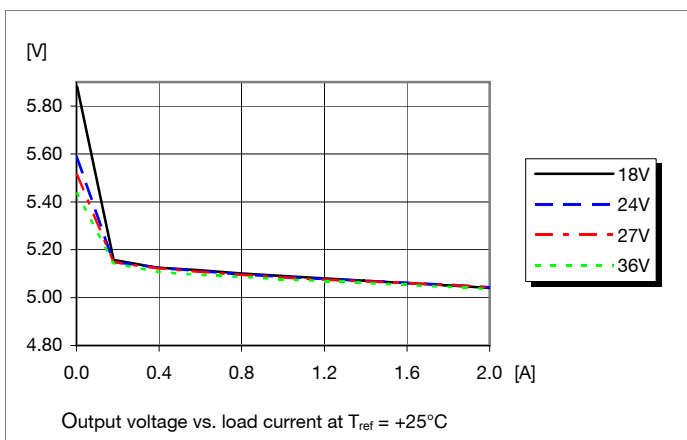

Current Limit Characteristics

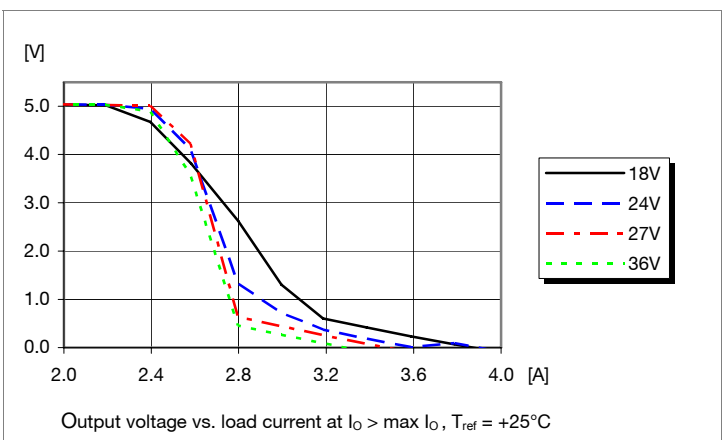

PKR 2000A SI series
DC/DC converters, Input 18-36 V, Output 2 A/12 W

EN/LZT 146 352 R1B August 2006

© Ericsson Power Modules AB

5 V/2 A Typical Characteristics

PKR 2111A SI

Start-up

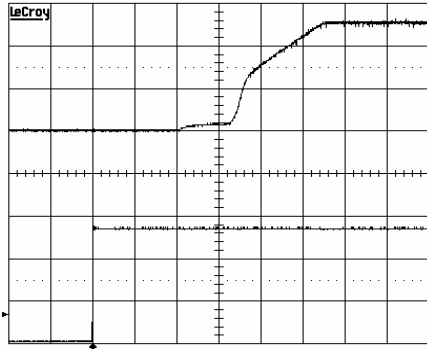

Start-up enabled by connecting V_i at:
 $T_{ref} = +25^{\circ}C$, $I_o = 2$ A resistive load,
 $V_i = 27$ V.
Top trace: output voltage (2 V/div.).
Bottom trace: input voltage (10 V/div.).
Time scale: 1 ms/div..

Shut-down

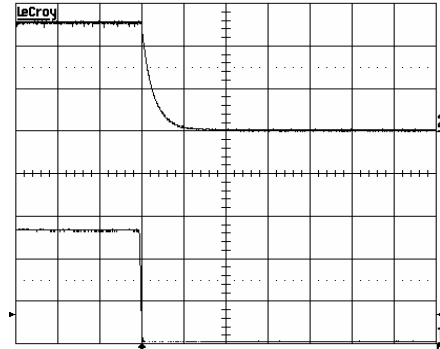

Shut-down enabled by disconnecting V_i at:
 $T_{ref} = +25^{\circ}C$, $I_o = 2$ A resistive load,
 $V_i = 27$ V.
Top trace: output voltage (2 V/div.). Bottom trace:
input voltage (10 V/div.).
Time scale: 1 ms/div..

Output Ripple & Noise

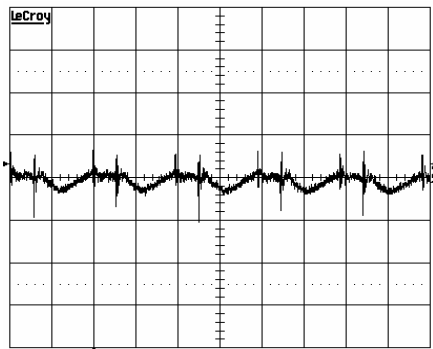

Output voltage ripple (5 mV/div.) at:
 $T_{ref} = +25^{\circ}C$, $I_o = 2$ A resistive load,
 $V_i = 27$ V. Time scale: 1 μ s/div.
See the filter in the Output ripple and noise
section (EMC Specification).

Output Load Transient Response

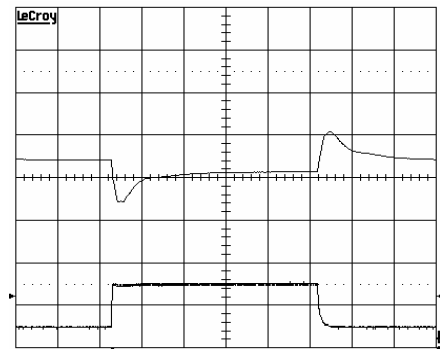

Output voltage response to load current
step-change (0.5-1.5-0.5 A) at:
 $T_{ref} = +25^{\circ}C$, $V_i = 27$ V.
Top trace: output voltage (200mV/div.).
Bottom trace: load current (1 A/div.).
Time scale: 0.1 ms/div.

Output Voltage Adjust (see operating information)

Passive trim

The resistor value for an adjusted output voltage is calculated by using the following equations:

Output Voltage Adjust Upwards, Increase:

$$R_{ou} = 4.20 \times (6.27 - V_o) / (V_o - V_o) \text{ k}\Omega$$

E.g. Increase 4% $\Rightarrow V_{out} = 5.25$ Vdc
 $4.20 \times (6.27 - 5.25) / (5.25 - 5.05) = 21.4 \text{ k}\Omega$

Output Voltage Adjust Downwards, Decrease:

$$R_{od} = 18 \times (V_{oi} - V_o) / (V_o - 2.76) \text{ k}\Omega$$

E.g. Decrease 2% $\Rightarrow V_{out} = 4.95$ Vdc
 $18 \times (5.05 - 4.95) / (4.95 - 2.76) = 0.822 \text{ k}\Omega$

PKR 2000A SI series
DC/DC converters, Input 18-36 V, Output 2 A/12 W

EN/LZT 146 352 R1B August 2006

© Ericsson Power Modules AB

12 V/1 A Electrical Specification

PKR 2113A SI

$T_{ref} = -30$ to $+95^{\circ}\text{C}$, $V_I = 18$ to 36 V, unless otherwise specified under Conditions.

Typical values given at: $T_{ref} = +25^{\circ}\text{C}$, $V_I = 27$ V, max I_O , unless otherwise specified under Conditions.

Characteristics		Conditions	min	typ	max	Unit
V_I	Input voltage range		18		36	V
V_{loff}	Turn-off input voltage	Decreasing input voltage	15	16		V
V_{lon}	Turn-on input voltage	Increasing input voltage		17.4	17.9	V
C_I	Internal input capacitance			2		μF
P_O	Output power	Output voltage initial setting	0		12	W
SVR	Supply voltage rejection (ac)	$f = 100$ Hz sine wave, 1 Vp-p		62		dB
η	Efficiency	50 % of max I_O		87		%
		max I_O		88		
		50 % of max I_O , $V_I = 24$ V		87.5		
		max I_O , $V_I = 24$ V		88		
P_d	Power Dissipation	max I_O		1.6	2.7	W
P_{li}	Input idling power	$I_O = 0$, $V_I = 27$ V		185		mW
P_{RC}	Input standby power	$V_I = 27$ V (turned off with RC)		20		mW
f_s	Switching frequency	10 -100% of max I_O	477	510	533	kHz

V_{oi}	Output voltage initial setting and accuracy	$T_{ref} = +25^{\circ}\text{C}$, $V_I = 27$ V, $I_O = 0.8$ A	11.94	12.00	12.06	V
	Output adjust range		6.5		15.0	V
V_O	Output voltage tolerance band	10-100% of max I_O	11.6		12.6	V
	Idling voltage	$I_O = 0$	12.5	13.0	14.5	V
	Line regulation	max I_O		10		mV
	Load regulation	$V_I = 27$ V, 10-100% of max I_O		240		mV
V_{tr}	Load transient voltage deviation	$V_I = 27$ V, Load step 25-75-25 % of max I_O , $di/dt = 1$ A/ μs		± 330		mV
t_{tr}	Load transient recovery time			150		μs
t_r	Ramp-up time (from 10-90 % of V_{oi})	10-100% of max I_O	0.2	2.3	5	ms
t_s	Start-up time (from V_I connection to 90% of V_{oi})		1	5	15	ms
I_O	Output current		0		1	A
I_{lim}	Current limit threshold	$V_O = 11$ V, $T_{ref} < \max T_{ref}$	1.2	1.4	2	A
I_{sc}	Short circuit current	$T_{ref} = 25^{\circ}\text{C}$		2.3		A
V_{Oac}	Output ripple & noise	Note 1, See ripple & noise section, max I_O , V_O .		8	50	mVp-p

Note 1: Output filter according to Ripple & Noise section

PKR 2000A SI series
DC/DC converters, Input 18-36 V, Output 2 A/12 V

EN/LZT 146 352 R1B August 2006

© Ericsson Power Modules AB

12 V/1 A Typical Characteristics

PKR 2113A SI

Efficiency

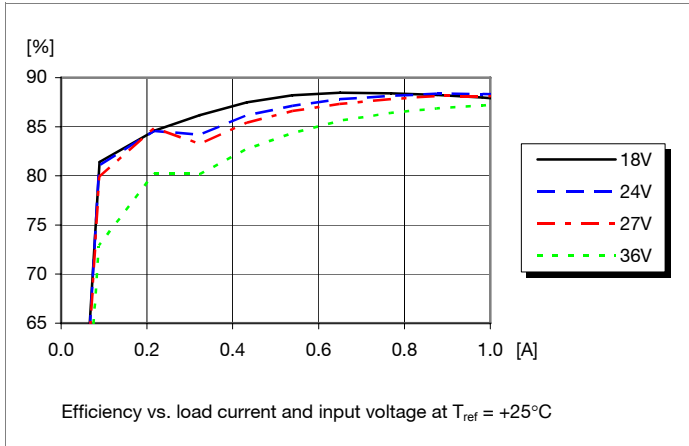

Power Dissipation

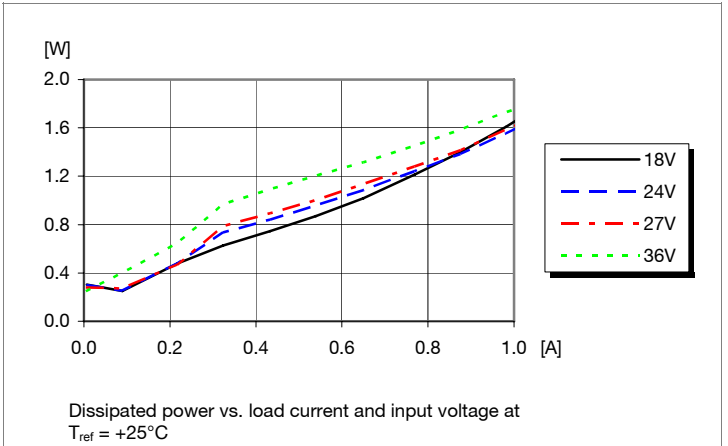

Output Current Derating

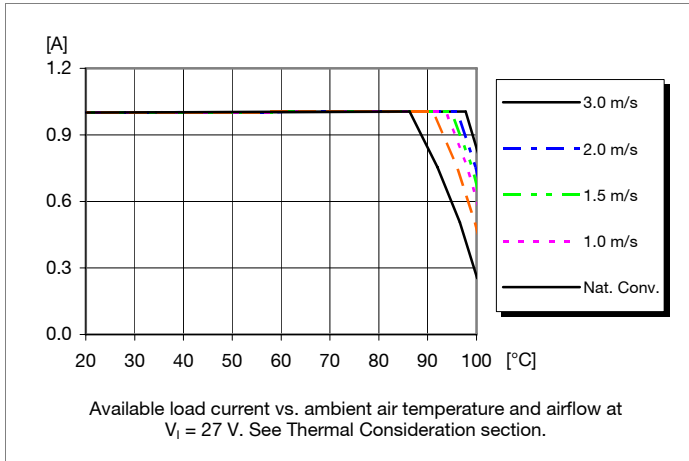

Thermal Resistance

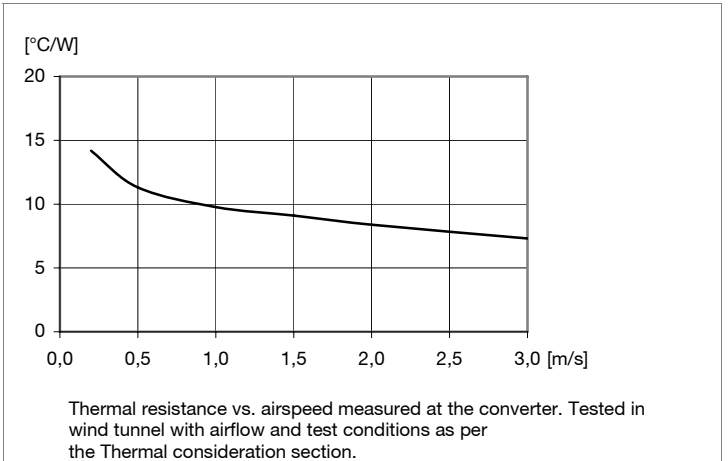

Output Characteristics

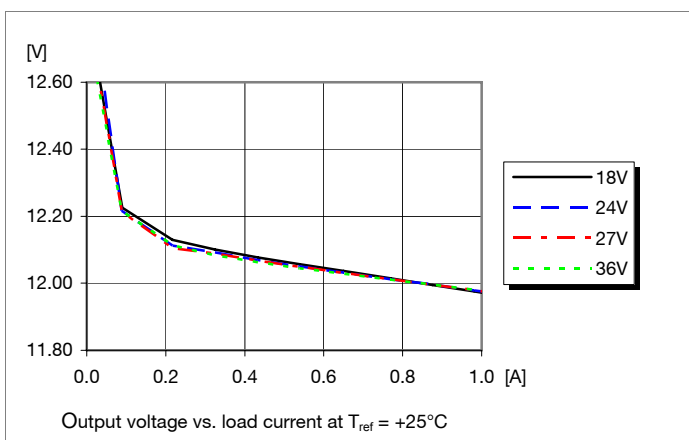

Current Limit Characteristics

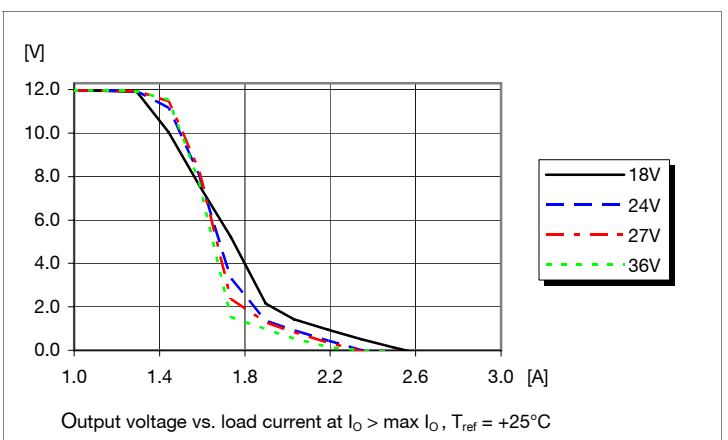

PKR 2000A SI series
DC/DC converters, Input 18-36 V, Output 2 A/12 W

EN/LZT 146 352 R1B August 2006

© Ericsson Power Modules AB

12 V/1 A Typical Characteristics

PKR 2113A SI

Start-up

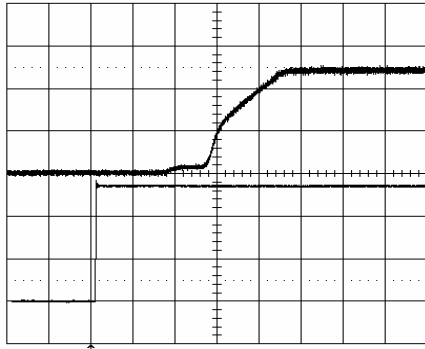

Start-up enabled by connecting V_i at:
 $T_{ref} = +25^{\circ}\text{C}$, $I_o = 1$ A resistive load,
 $V_i = 27$ V.

Top trace: output voltage (5 V/div.).
Bottom trace: input voltage (10 V/div.).
Time scale: 5 ms/div..

Shut-down

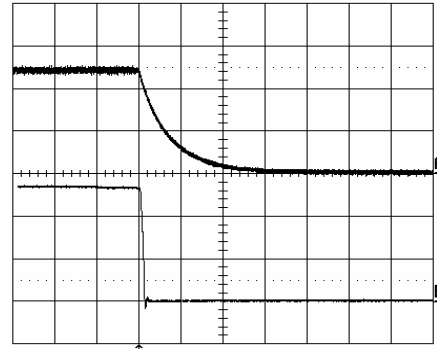

Shut-down enabled by disconnecting V_i at:
 $T_{ref} = +25^{\circ}\text{C}$, $I_o = 1$ A resistive load,
 $V_i = 27$ V.

Top trace: output voltage (5 V/div.). Bottom trace:
input voltage (10 V/div.).
Time scale: 0.5 ms/div..

Output Ripple & Noise

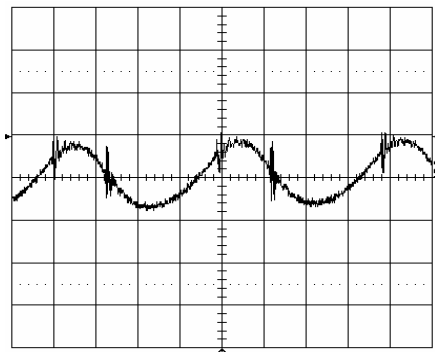

Output voltage ripple (5mV/div.) at:
 $T_{ref} = +25^{\circ}\text{C}$, $I_o = 1$ A resistive load,
 $V_i = 27$ V. Time scale: 0.5 μs/div.

See the filter in the Output ripple and noise
section (EMC Specification).

Output Load Transient Response

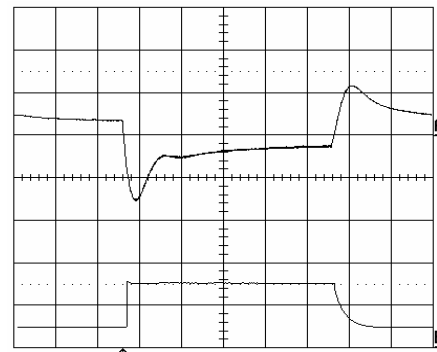

Output voltage response to load current
step-change (0.25-0.75-0.25 A) at:
 $T_{ref} = +25^{\circ}\text{C}$, $V_i = 27$ V.

Top trace: output voltage (200mV/div.).
Bottom trace: load current (0.5 A/div.).
Time scale: 0.1 ms/div.

Output Voltage Adjust (see operating information)

Passive trim

The resistor value for an adjusted output voltage is calculated by using the following equations:

Output Voltage Adjust Upwards, Increase:

$$R_{ou} = 4.20 \times (15 - V_o) / (V_o - V_{o1}) \text{ k}\Omega$$

E.g. Increase 4% $\Rightarrow V_{out} = 12.48$ Vdc
 $4.20 \times (15 - 12.48) / (12.48 - 12.00) = 22.1 \text{ k}\Omega$

Output Voltage Adjust Downwards, Decrease:

$$R_{od} = 18.6 \times (V_{oi} - V_o) / (V_o - 6.5) \text{ k}\Omega$$

E.g. Decrease 2% $\Rightarrow V_{out} = 11.76$ Vdc
 $18.6 \times (12.00 - 11.76) / (11.76 - 6.5) = 0.849 \text{ k}\Omega$

PKR 2000A SI series
DC/DC converters, Input 18-36 V, Output 2 A/12 W

EN/LZT 146 352 R1B August 2006

© Ericsson Power Modules AB

EMC Specification

Conducted EMI measured according to EN55022, CISPR 22 and FCC part 15J (see test set-up).
The fundamental switching frequency is 510 kHz for PKR 2000A @ $V_I = 27\text{ V}$, max I_O .

Conducted EMI Input terminal value (typ)

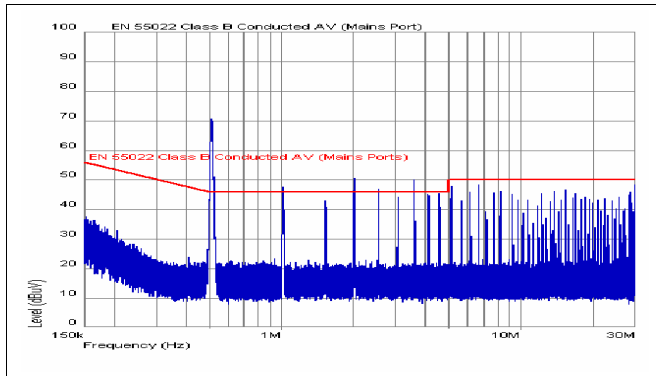

EMI without filter

External filter (class B)

Required external input filter in order to meet class B in EN 55022, CISPR 22 and FCC part 15J.

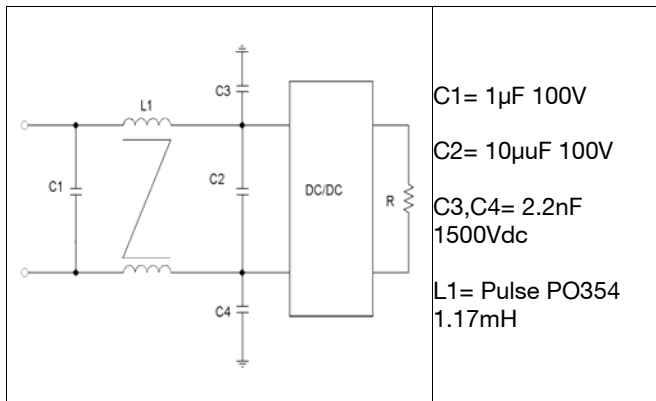
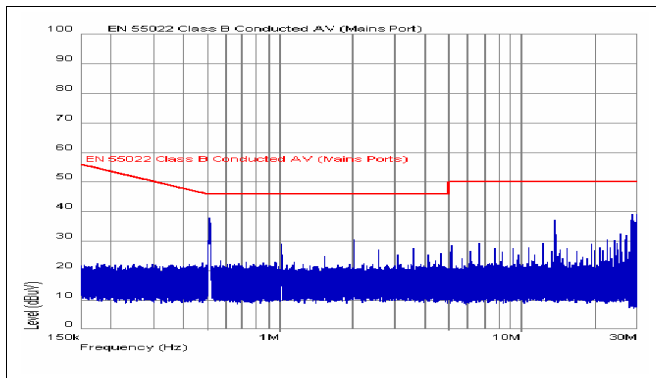

EMI with filter

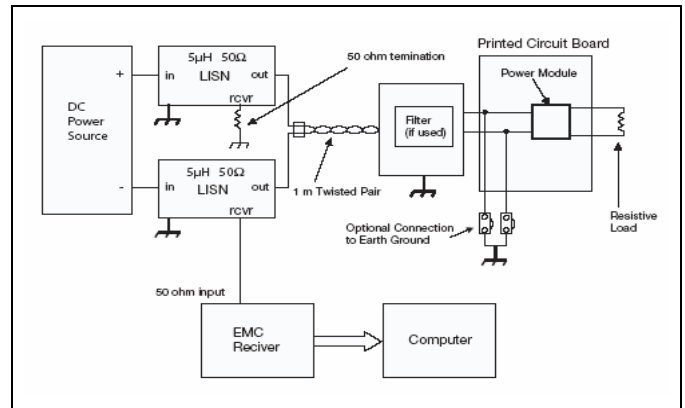

Test set-up

Layout recommendation

The radiated EMI performance of the DC/DC converter will depend on the PCB layout and ground layer design. It is also important to consider the stand-off of the DC/DC converter.

A ground layer will increase the stray capacitance in the PCB and improve the high frequency EMC performance.

Output ripple and noise

Output ripple and noise measured according to figure below.

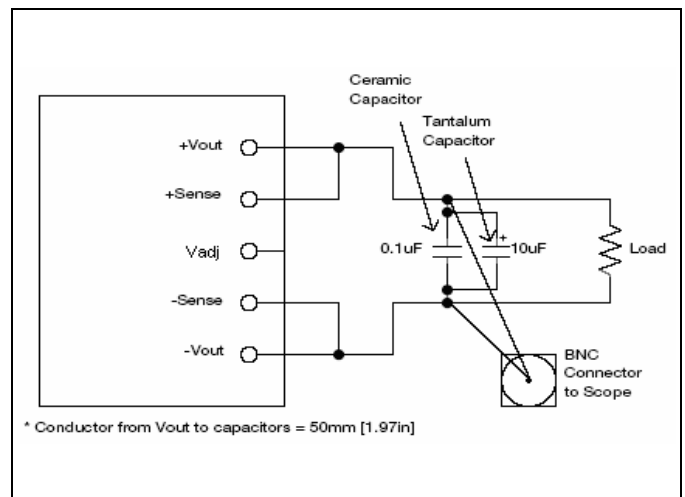

Output ripple and noise test setup

PKR 2000A SI series
DC/DC converters, Input 18-36 V, Output 2 A/12 W

EN/LZT 146 352 R1B August 2006

© Ericsson Power Modules AB

Operating information

Input Voltage

The input voltage range 18... 36 Vdc.
At input voltages exceeding 36 V, the power loss will be higher than at normal input voltage and T_{ref} must be limited to absolute max +95°C. The absolute maximum continuous input voltage is 36 Vdc.

Turn-off Input Voltage

The converters monitor the input voltage and will turn on and turn off at predetermined levels. The minimum hysteresis between turn on and turn off input voltage is 0.6V.

To increase V_{lon} a resistor should be connected between pin 11 and 18.

The resistance is given by the following equation
(For $V_{lon} > 18V$):

$$R_{lon} = (800 - V_{lon}) / (V_{lon} - 17.2) \text{ k}\Omega$$

V_{loff} is the adjusted turn-off input voltage and is determined by $V_{lon} - V_{loff} = 0.8V$ (Typical value).

Output Voltage Adjust (V_{adj})

All converters have an Output Voltage Adjust pin (V_{adj}). This pin can be used to adjust the output voltage above or below Output voltage initial setting.

At increased output voltages the maximum power rating of the converter remains the same, and the max output current must be decreased correspondingly.

To increase the voltage the resistor should be connected between the V_{adj} pin and -IN. The resistor value of the Output voltage adjust function is according to information given under the Output section for the respective product.

To decrease the output voltage, the resistor should be connected between the V_{adj} pin and NOR pin.

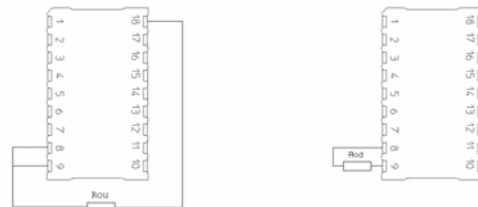

Remote Control (RC)

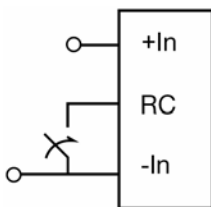

The products are fitted with a remote control function referenced to the primary negative input connection (- In), and have positive logic. The RC function allows the converter to be turned on/off by an external device like a semiconductor or mechanical switch.

The maximum required sink current is 1 mA. When the RC pin is left open, the voltage generated on the RC pin is <16 V. To ensure that the converter stays off the voltage must be below 1.0 V.

PKR 2000A SI series
DC/DC converters, Input 18-36 V, Output 2 A/12 W

EN/LZT 146 352 R1B August 2006
© Ericsson Power Modules AB

Operating information, cont.

Input And Output Impedance

The impedance of both the input source and the load will interact with the impedance of the DC/DC converter. It is important that the input source has low characteristic impedance. The converters are designed for stable operation without external capacitors connected to the input or output. The performance in some applications can be enhanced by addition of external capacitance as described under External Decoupling Capacitors. If the input voltage source contains significant inductance, the addition of a 10 µF capacitor across the input of the converter will ensure stable operation. The capacitor is not required when powering the DC/DC converter from an input source with an inductance below 10 µH.

External Decoupling Capacitors

When powering loads with significant dynamic current requirements, the voltage regulation at the point of load can be improved by addition of decoupling capacitors at the load. The most effective technique is to locate low ESR ceramic and electrolytic capacitors as close to the load as possible by using several parallel capacitors to lower the effective ESR. The ceramic capacitors will handle high-frequency dynamic load changes while the electrolytic capacitors are used to handle low frequency dynamic load changes. Ceramic capacitors will also reduce any high frequency noise at the load.

It is equally important to use low resistance and low inductance PCB layouts and cabling.

External decoupling capacitors will become part of the control loop of the DC/DC converter and may affect the stability margins. As a “rule of thumb”, 100 µF/A of output current can be added without any additional analysis.

The recommended absolute maximum value of output capacitance is 10 000 µF. For further information please contact your local Ericsson Power Modules representative.

Parallel Operation

Paralleling of several converters is easily accomplished by direct connection of the output voltage terminal pins. The load regulation characteristic is specifically designed for optimal paralleling performance. Load sharing between converters will be within ±10%. It is recommended not to exceed $P_o = n \times 0.9 \times P_{o,max}$, where $P_{o,max}$ is the maximum converter output power and n is the number of paralleled converters, to prevent overloading any of the converters and thereby decreasing the reliability performance.

Temperature Shutdown

The PKR 2000A Series DC/DC converters include an internal over temperature shutdown circuit. When the temperature exceeds 130°C - 150°C on the control circuit the converter will shut down. The DC/DC converter will make continuous attempts to start up (non-latching mode) and resume normal operation automatically when the temperature has dropped >15°C below the temperature threshold.

Synchronization (Sync)

It is possible to synchronize the switching frequency to an external symmetrical clock signal. The input can be driven by an TTL-compatible output and reference to the -input pin 18.

Characteristic	Min	Typ	Max	Unit
High level	2.2		6.5	V
Threshold level*)	1.2	1.7	2.2	V
Low level	0		0.4	V
Sink current			1.5	mA
Sync. Frequency	520		668	kHz

*) Rise time < 10ns

Over Current Protection (OCP)

The converters include current limiting circuitry for protection at continuous overload. The output voltage will decrease towards zero for output currents in excess of max output current (max I_o). The converter will resume normal operation after removal of the overload. The load distribution should be designed for the maximum output short circuit current specified.

PKR 2000A SI series
DC/DC converters, Input 18-36 V, Output 2 A/12 W

EN/LZT 146 352 R1B August 2006

© Ericsson Power Modules AB

Thermal Consideration

General

The converters are designed to operate in different thermal environments and sufficient cooling must be provided to ensure reliable operation.

Cooling is achieved mainly by conduction, from the pins to the PCB board, and convection, which is dependant on the airflow across the converter. Increased airflow enhances the cooling of the converter.

The Output Current Derating graph found in the Output section for each model provides the available output current vs. ambient air temperature and air velocity at $V_{in} = 27 V$.

The converter is tested on a 254 x 254 mm, 35 μm (1 oz), 8-layer test board mounted vertically in a wind tunnel with a cross-section of 305 x 305 mm.

Proper cooling of the converter can be verified by measuring the temperature at position P1. The temperature at these positions should not exceed the max values provided in the table below.

Note that the max value is the absolute maximum rating (non destruction) and that the electrical Output data is guaranteed up to $T_{ref} +95^{\circ}C$.

Position	Device	Designation	max value
P ₁	Transformer	T _{ref}	110° C

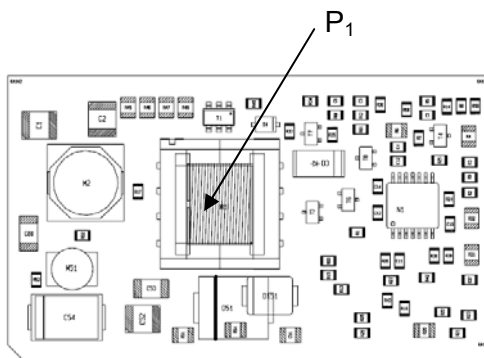

Ambient Temperature Calculation

By using the thermal resistance the maximum allowed ambient temperature can be calculated.

1. The power loss is calculated by using the formula $((1/\eta) - 1) \times \text{output power} = \text{power losses (Pd)}$.
 η = efficiency of converter. E.g. 84 % = 0.84

2. Find the thermal resistance (Rth) in the Thermal Resistance graph found in the Output section for each model.
Calculate the temperature increase (ΔT).
 $\Delta T = Rth \times Pd$

3. Max allowed ambient temperature is:
 $\text{Max } T_{ref} - \Delta T$.

E.g. PKR 5113 at 1m/s:

1. $((\frac{1}{0.84}) - 1) \times 11 W = 2.1 W$

2. $2.1 W \times 7.6^{\circ}C/W = 16.0^{\circ}C$

3. $110^{\circ}C - 16.0^{\circ}C = \text{max ambient temperature is } 94.0^{\circ}C$

The actual temperature will be dependent on several factors such as the PCB size, number of layers and direction of airflow.

PKR 2000A SI series
DC/DC converters, Input 18-36 V, Output 2 A/12 W

EN/LZT 146 352 R1B August 2006

© Ericsson Power Modules AB

Connections

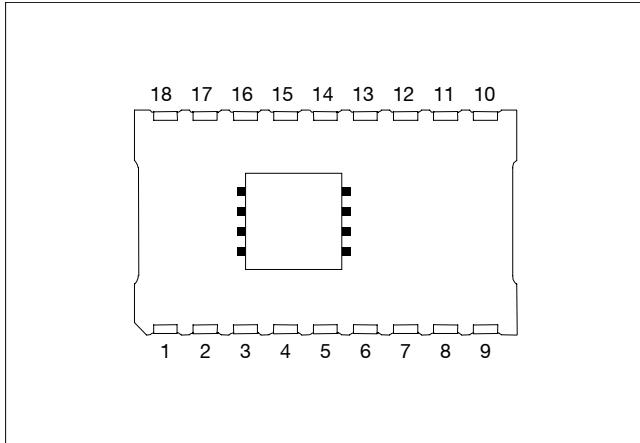

Pin	Designation	Function
1	Out 1	Output 1
2	Rtn	Output return
3	Out 2	Output 2
4	NC	Not connected
5	NC	Not connected
6	NC	Not connected
7	Sync	Synchronization input
8	Vadj	Output voltage adjust
9	NOR	Connection of Nominal Output voltage Resistor ¹⁾
10	TOA	Turn-on/off input voltage adjust
11	RC	Remote control. Used to turn-on/off output
12	NC	Not connected
13	NC	Not connected
14	NC	Not connected
15	NC	Not connected
16	NC	Not connected
17	+ In	Positive Input
18	-In	Negative input

¹⁾ Nominal voltage when pin 8 & 9 are connected together.

PKR 2000A SI series
DC/DC converters, Input 18-36 V, Output 2 A/12 W

EN/LZT 146 352 R1B August 2006

© Ericsson Power Modules AB

Mechanical information - physical specifications (for assembly information, see next page)

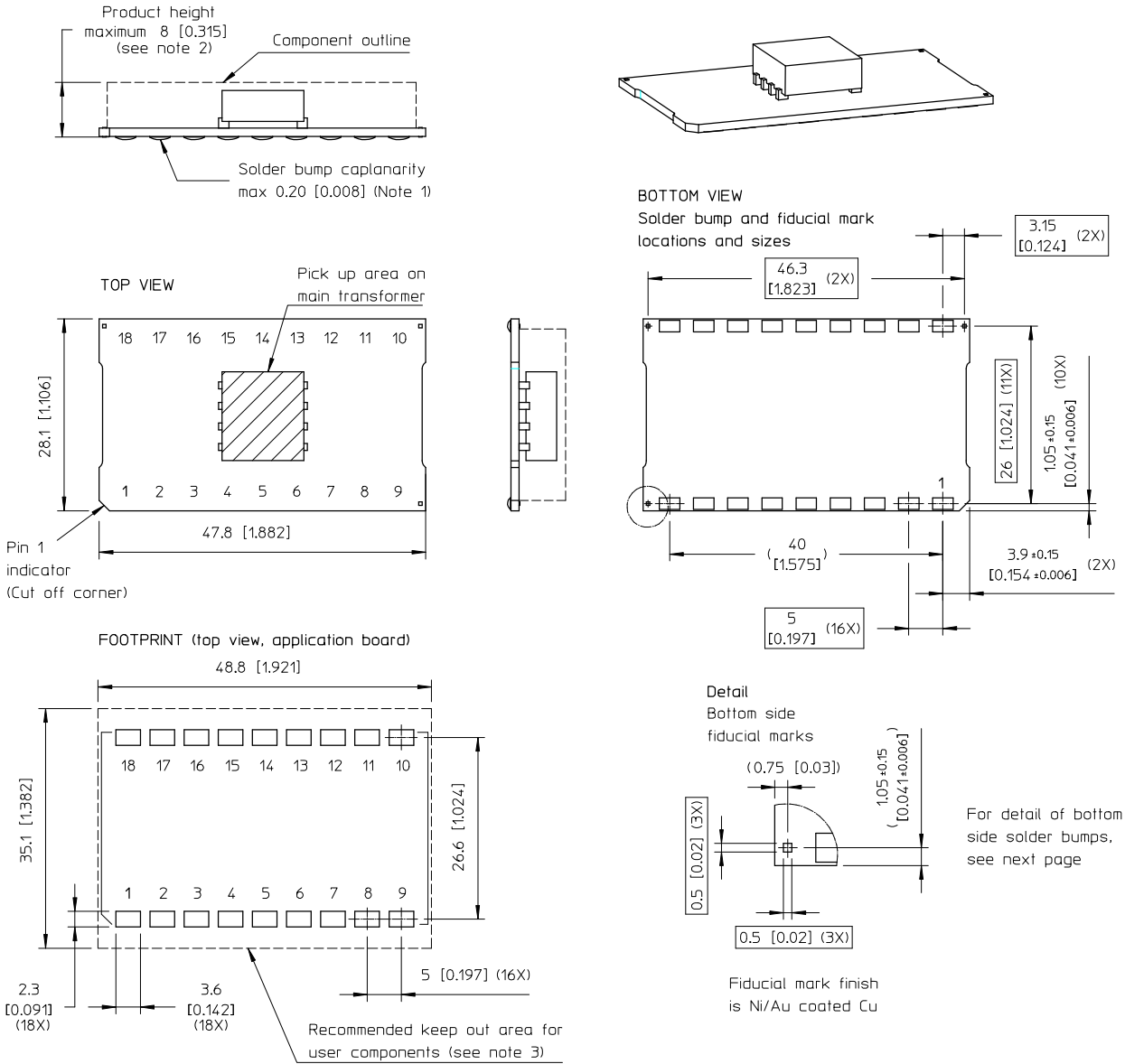

NOTES

1. The solder bumps are designed to allow coplanarity compensation by melting of the solder bumps between the product and the application board. The coplanarity corresponds to the requirements for BGA low melt solder balls. (Jedec Publication 95, Design Guide 4.14 revision E, september 2005)
2. Max product height is measured from bottom side of the product PCB but excluding the solder bump (reduced to solder joint thickness after assembly)
3. Absolute keep out area = 48.8 x 29.1 based on mechanical outline and assembly tolerances. The recommended keep out area is +3 mm on each long side to facilitate repair (removal and re-mounting) with a hot air nozzle.

Weight: 9-12 g

All dimensions in mm [inch]

Tolerances unless specified ± 0.26 [0.01] (not applied on footprint or typical values)

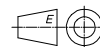

Boxed dimensions ±0.05 [±0.002]

PKR 2000A SI series
DC/DC converters, Input 18-36 V, Output 2 A/12 W

EN/LZT 146 352 R1B August 2006

© Ericsson Power Modules AB

Mechanical information, continued

BOTTOM VIEW

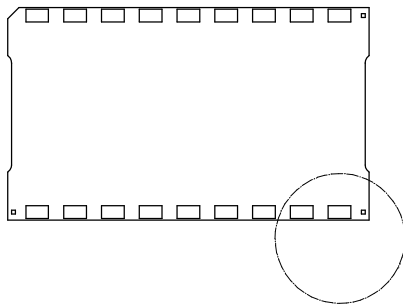

Detail

Bottom side solder bumps

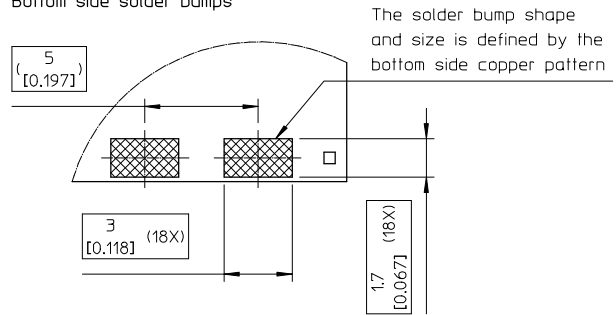

Solder bump composition: no-clean SAC solder, approximate composition Sn96/Ag3/Cu1, melting range 217-221°C

APPLICATION VIEW (detail)

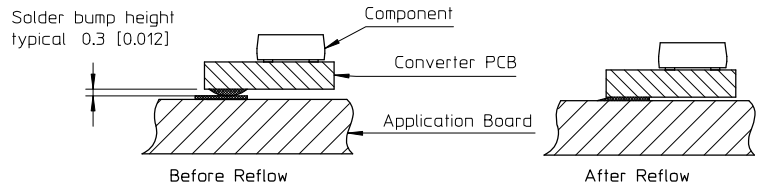

ALTERNATIVE FOOTPRINT, equal to the recommended PKF footprint (top view, application board)

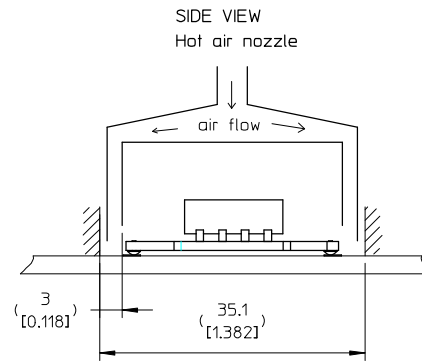
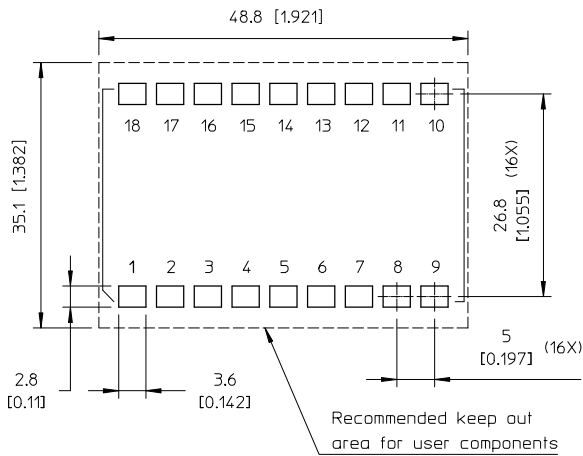

Illustration of a recommended design for a hot air repair nozzle for manual removal and re-mounting

The recommended footprint (see previous page) is optimised for the solder bump design. However, the standard PKF footprint will also accommodate this solder bump design. The only differences are the solder pad width (2.8 versus 2.3 mm) and the c-c distance between the two rows of connectors (26.8 versus 26.6 mm).

The absolute and recommended keep out areas are not affected by the differences in application board footprint.

Weight: 9-12 g
All dimensions in mm [inch]
Tolerances unless specified ± 0.26 [0.01]
(not applied on footprint or typical values)



Boxed values: ±0.05 [±0.002]

PKR 2000A SI series
DC/DC converters, Input 18-36 V, Output 2 A/12 W

EN/LZT 146 352 R1B August 2006

© Ericsson Power Modules AB

Soldering Information - Surface mounting

The product is intended for use in a convection or vapor phase reflow process. To achieve a good and reliable soldering result, make sure to follow the recommendations from the solder paste supplier, to use state-of-the-art reflow equipment and reflow profiling techniques as well as the following guidelines.

When using an Sn/Pb solder in the host board assembly process, the composition of the mix of Pb- and Pb-free solder results in a higher melting temperature compared to standard Pb solder.

A no-clean flux is recommended to avoid entrapment of cleaning fluids in cavities inside the product. The cleaning residues may affect long time reliability and isolation voltage.

Minimum pin temperature recommendations

Pin number 5 and 14 are chosen as reference locations for the minimum pin temperature recommendations since these will be the coolest solder joints during the reflow process.

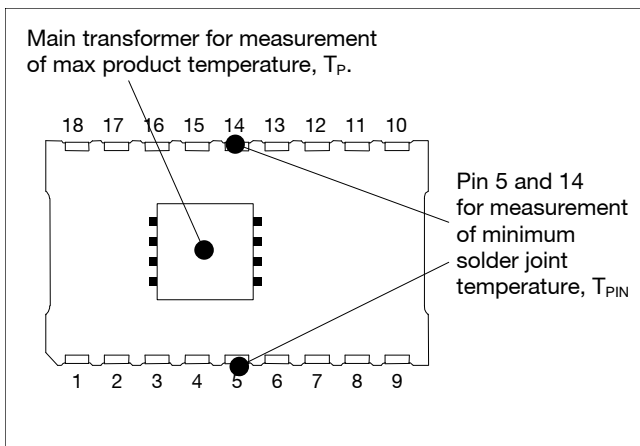

SnPb solder processes

For Pb solder processes, a pin temperature (T_{PIN}) in excess of the solder melting temperature, (T_L , +183°C for Sn63/Pb37) for more than 30 seconds, and a peak temperature of +210°C is recommended to ensure a reliable solder joint.

Lead-free (Pb-free) solder processes

For Pb-free solder processes, a pin temperature (T_{PIN}) in excess of the solder melting temperature (T_L , +217 to +221 °C for Sn/Ag/Cu solder alloys) for more than 30 seconds, and a peak temperature of minimum +235°C on all solder joints is recommended to ensure a reliable solder joint.

Maximum converter temperature requirements

To avoid damage or performance degradation of the product, the reflow profile should be optimized to avoid excessive heating. The maximum product temperature shall be monitored by attaching a thermocoupler to the top of the main transformer.

A sufficiently extended preheat time is recommended to ensure an even temperature across the host PCB, for both small and large devices. To reduce the risk of excessive heating is also recommended to reduce the time in the reflow zone as much as possible.

SnPb solder processes

For conventional SnPb solder processes, the product is qualified for MSL 1 according to IPC/JEDEC standard J-STD-020C.

During reflow, T_p must not exceed +225 °C at any time.

Lead-free (Pb-free) solder processes

For Pb-free solder processes, the product is qualified for MSL 3 according to IPC/JEDEC standard J-STD-020C.

During reflow, T_p must not exceed +245 °C at any time.

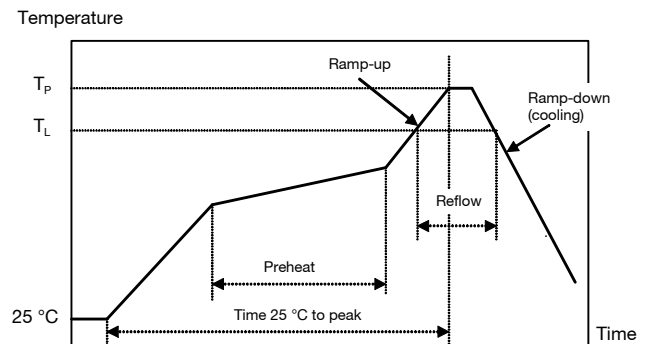

Profile features		Sn/Pb eutectic assembly	Pb-free assembly
Average ramp-up rate		3 °C/s max	3 °C/s max
Solder melting temperature (typical)	T_L	+183 °C	+221 °C
Peak product temperature	T_p	+225 °C	+245 °C
Average ramp-down rate		6 °C/s max	6 °C/s max
Time 25 °C to peak temperature		6 minutes max	8 minutes max

PKR 2000A SI series
DC/DC converters, Input 18-36 V, Output 2 A/12 W

EN/LZT 146 352 R1B August 2006

© Ericsson Power Modules AB

Delivery package information

The products are delivered in antistatic injection molded trays (Jedec design guide 4.10D standard) or in antistatic carrier tape (EIA 481 standard).

Carrier tape specifications	
Material	Polystyrene (PS), conductive
Surface resistance	$< 10^7$ ohms/square
Bakability	The tape is not bakable
Tape width	72 mm [2.835 inch]
Pocket pitch	36 mm [1.417 inch]
Pocket depth	9.2 mm [0.362 inch]
Reel diameter	330 mm [13 inch]
Reel capacity	150 products/reel
Reel weight	300 products (2 reels/box)

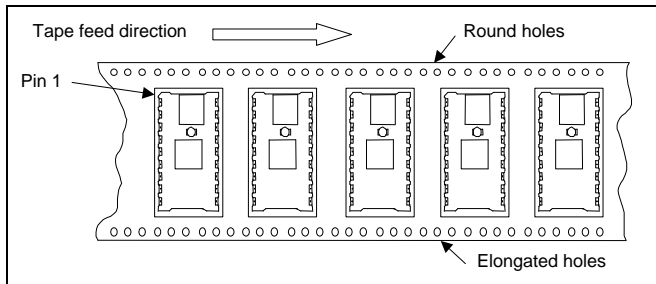

Tray specifications	
Material	Dissipative PPE}
Surface resistance	$10^5 < \text{ohms/square} < 10^{12}$
Bake ability	The trays can be baked at maximum 125 °C for 48 hours
Tray capacity	15 products/tray
Box capacity	150 products (10 full trays/box)
Tray weight	140 g empty, 320 g full maximum

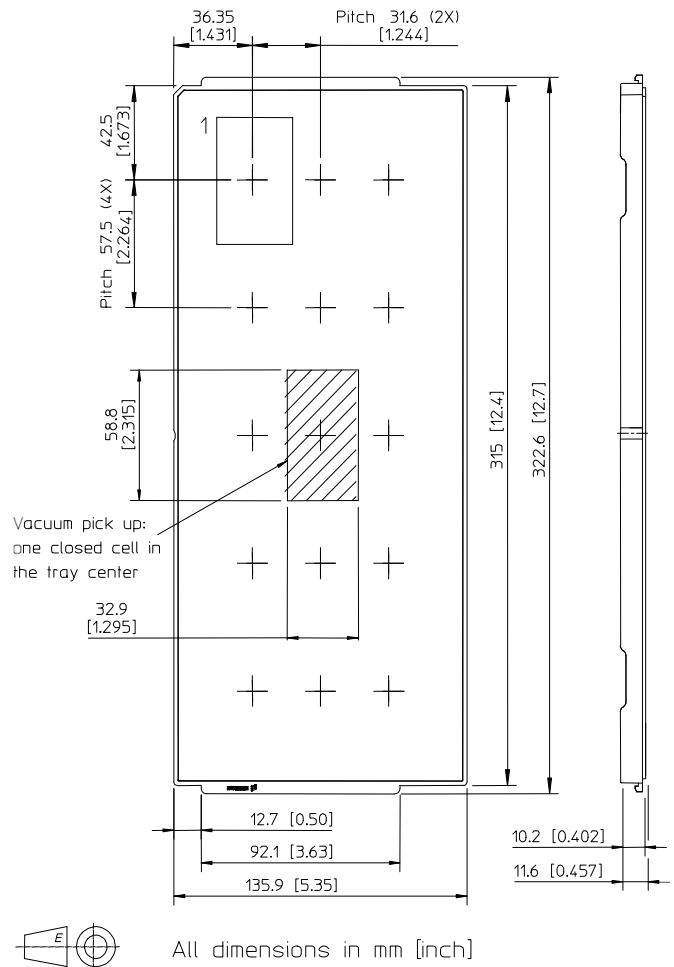

Dry pack information

The product is delivered in trays or tape & reel. These inner shipment containers are dry packed in standard moisture barrier bags according to IPC/JEDEC standard J-STD-033 (Handling, packing, shipping and use of moisture/reflow sensitivity surface mount devices).

Using products in high temperature Pb-free soldering processes requires dry pack storage and handling. In case the products have been stored in an uncontrolled environment and no longer can be considered dry, the modules must be baked according to J-STD-033.

PKR 2000A SI series DC/DC converters, Input 18-36 V, Output 2 A/12 W	EN/LZT 146 352 R1B August 2006
	© Ericsson Power Modules AB

Product Qualification Specification

Characteristics			
External visual inspection	IPC-A-610		
Operational life test	MIL-STD-202G method 108A With power cycling	T _{ref} Load Duration	According to Absolute maximum ratings Maximum output power 500 h
Vibration, broad band random	IEC 60068-2-64 Fh	Frequency Acceleration spectral density Crest factor Duration and directions	10 to 500 Hz 0.5 g ² /Hz 3 10 min in each 3 perpendicular directions
Vibration, sinusoidal	IEC 68-2-64 F _c	Frequency Amplitude Acceleration Sweep rate Duration	10 to 500 Hz 0.75 mm 10 g 1 octave/min 2 h in each 3 perpendicular directions
Mechanical shock	IEC 68-2-27 E _a	Peak acceleration Duration Pulse shape Directions Number of pulses	100 g 6 ms Half sine 6 18 (3 + 3 in each perpendicular direction)
Change of temperature (Temperature cycling)	IEC 60068-2-14 Na	Temperature range Number of cycles Dwell time	-40 to +100 °C 300 30 min
Robustness of terminations	IEC 68-2-21 U _{e1}	Depth of bending Time of remaining bent	3 mm 5 s
Solderability	IEC 68-2-58 T _d	Temperature, SnPb Eutectic Temperature, Pb free Preconditioning	215 ±5 °C 245 ±5 °C 240 h in 85°C/85%RH
Damp heat	IEC 60068-2-67 Cy with bias	Temperature Humidity Duration Preconditioning	+85 °C 85 % RH 500 hours Reflowed 3X according to IPC/JEDEC J-STD-020C MSL3 at 260°C
Moisture reflow sensitivity classification	J-STD-020C	SnPb Eutectic Pb free	MSL 1, peak reflow at 225 °C MSL 3, peak reflow at 245 °C
Immersion in cleaning solvents	IEC 68-2-45 XA Method 2	Water Isopropyl alcohol Glycol ether	+55 ±5 °C +35 ±5 °C +35 ±5 °C
Cold (in operation)	IEC 68-2-1 A _d	Temperature T _A Duration	-40 °C 72 h