

CAD GENERATED DRAWING. DON'T CHANGE BY HAND.

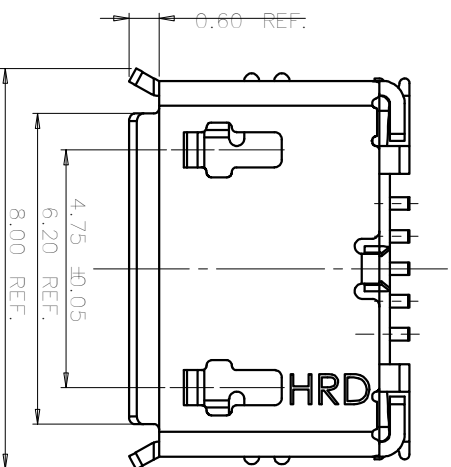
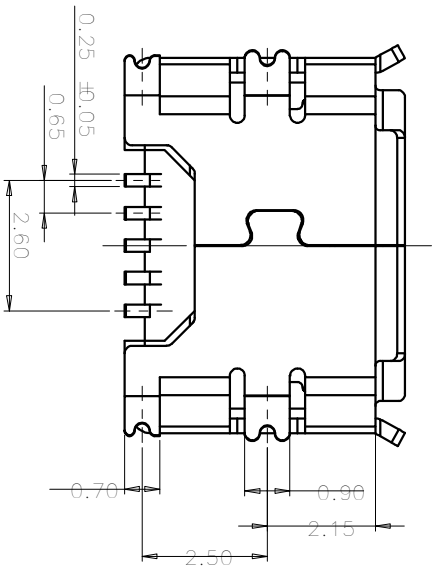
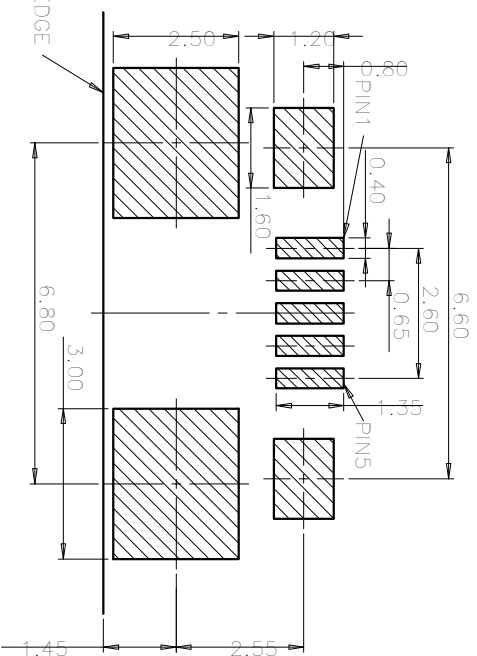
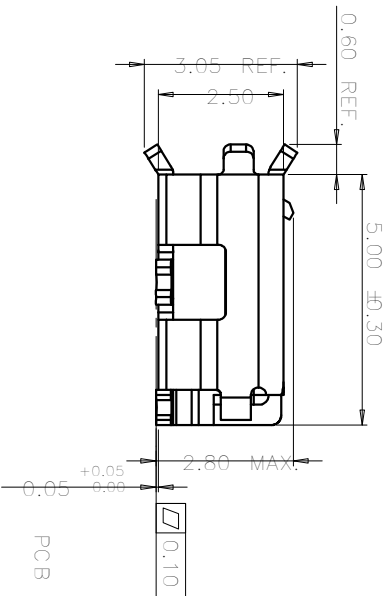
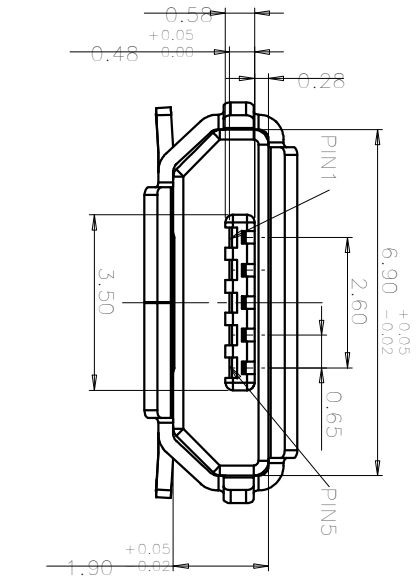

TOP VIEW

- NOTES:
1. MATERIAL:
HOUSING: LCP
CONTACT: COPPER ALLOY
SHELL: STAINLESS STEEL.
 2. FINISH:
CONTACT: Au PLATING OVER ALL
SHELL: TIN PLATED
 3. GP PASSED ACCORD WITH ROHS STANDARD.
 4. ALL DIMENSIONS MARKED MUST BE CONTROLLED BY QC.

RECOMMENDED PCB LAYOUT
TOLERANCE: ±0.05

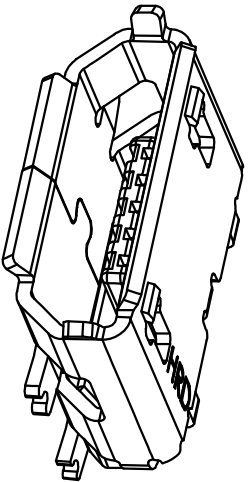

REV.	DESCRIPTION	DESIGN
A0	Initial Release	

深圳市宏艺康精密组件有限公司
 PART NO.: **HYAU09002501**
 TITLE: CUSTOMER DWG.
MICRO USB SPIN

DIM	TOL	DIM	TOL
X	±0.30	X°	±2°
X	±0.25	X°	±1°
XX	±0.20	XX°	±0.5°
XXX	±0.15		

DR: _____
 APPD: _____
 CHKD: _____
 DWG NO: _____
 UNITS: mm SCALE SHEET: N/A REV: 1/1