

MODEL	SPECIFICATION RoHS Compliant DIP SWITCH	SP-001	Page
BS series Box Slide Type			1/8

Ordering Information:

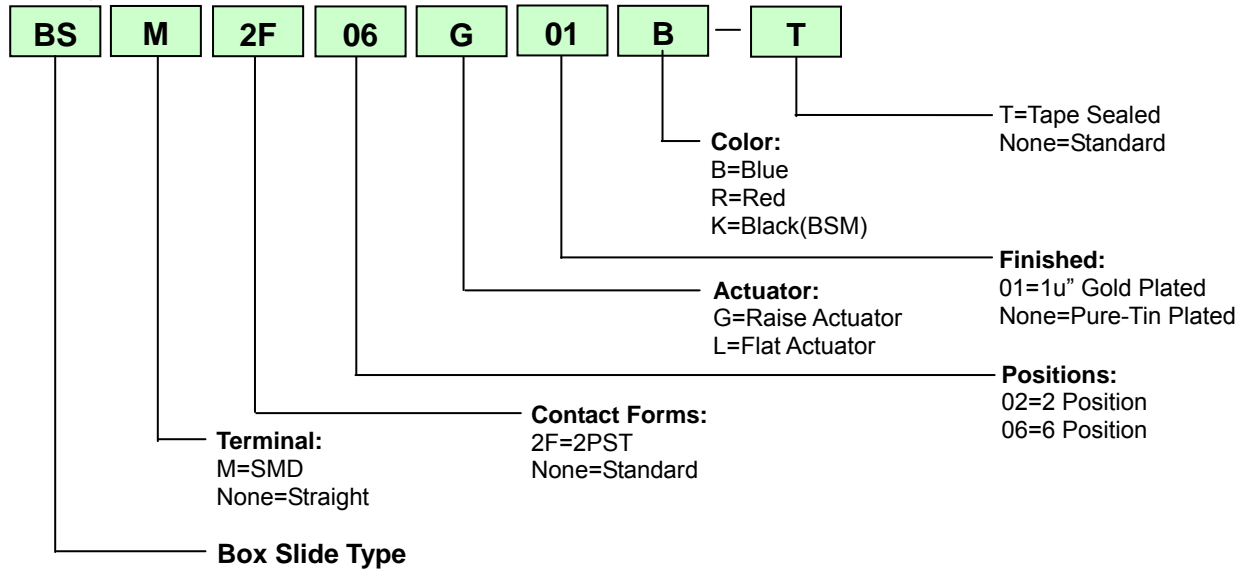

Specifications

◆ Contact Rating	Switching..... 25mA, 24VDC
	Non-Switching.....100mA, 50VDC
◆ Contact Resistance	Initial.....50mΩ Max.
	After Life Test.....100mΩ Max.
◆ Insulation Resistance100MΩ Min. at 500VDC
◆ Dielectric Strength500VDC / 1 minute
◆ Operation Force1,000g max
◆ Travel :1.8mm
◆ Mechanical Life 5,000 cycles (Min.)
◆ Electrical Life 3,000 cycles / 25mA, 24VDC
◆ Operation Temperature-40°C ~ +85°C
◆ Storage Temperature-40°C ~ +85°C

MODEL	SPECIFICATION	SP-002	Page
BS series Box Slide Type			RoHS Compliant DIP SWITCH

Soldering Information

◆ **Hand Soldering**

Soldering iron 30W or under at 350°C for 3 sec max or at 270°C for 5 sec max.

◆ **Reflow Soldering**

(1) Gold-plated series available 2~3 times process

(2) Tin-plated series available 1 time process

(3) Vapor Phase Heating (VPH) switch must with Tape sealed type

◆ **Wave Soldering**

For lead free wave solder simulation of typical components, the solder bath temperature

Shall be maintained to 275°C.

The hold time in the solder shall be 10 +2/-0 seconds.

◆ Keep all actuators in“OFF”position during soldering and cleaning process.

Classification Reflow Profiles

Profile Feature	Pb-Free Assembly
Preheat / Soak	
Temperature Min (T_{smin})	150°C
Temperature Max (T_{smax})	200°C
Time(ts) from (T_{smin} to T_{smax})	60 ~ 120 seconds
Ramp-up Rate (T_L to T_p)	3°C/second max
Liquidous temperature (T_L)	217°C
Time (t_L) maintained above to T_L	60 ~ 150 seconds
Peak package body temperature (T_p)	For users T_p must not exceed the Classification temp:250°C (Package Thickness>2.5mm) For suppliers T_p must equal or exceed the Classification temp:250°C (Package Thickness>2.5mm)
Time (t_p) within 5°C of specified classification Temperature (T_c)	30 seconds
Ramp-Down Rate (T_p to T_L)	6°C/second max
Time 25°C to Peak Temperature	8 minutes max
* Tolerance for peak profile temperature(T_p) is defined as a supplier minimum and a user maximum	

Note 1: All temperatures refer to topside of the package, measured on the package body surface.

Note 2: Time within 5 °C of actual peak temperature (t_p) specified for the reflow profiles is a “supplier” minimum and “user” maximum.

The table copy from IPC/JEDEC J-STD-020 D.1

Reflow Soldering Standard Conditions

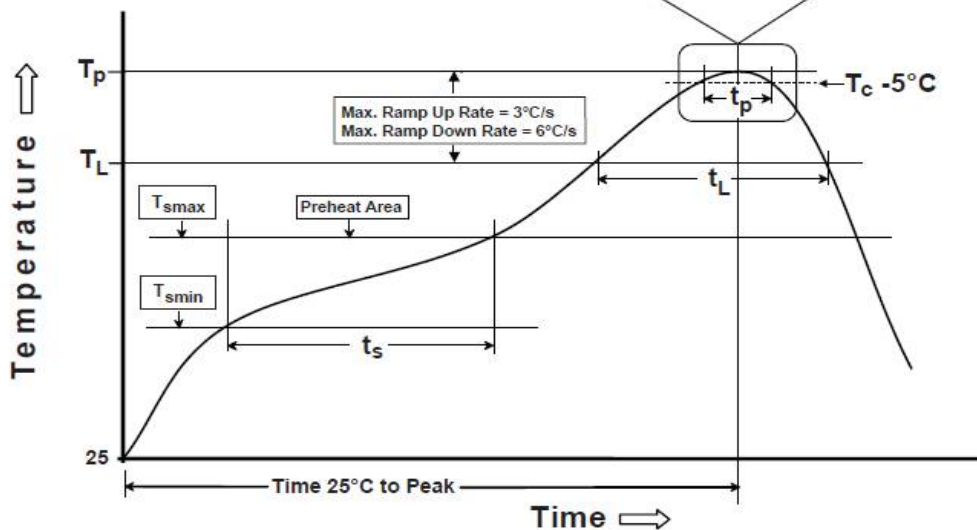
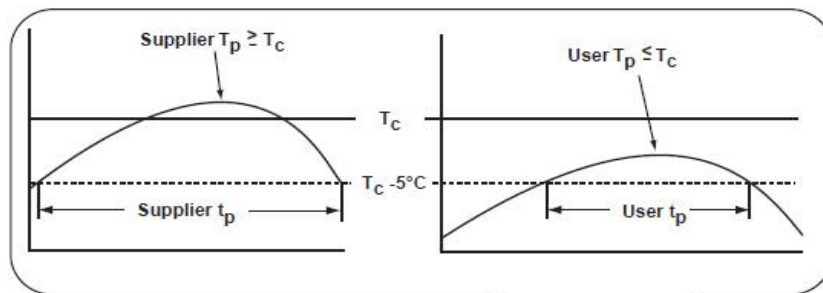

Classification Wave Soldering Profiles

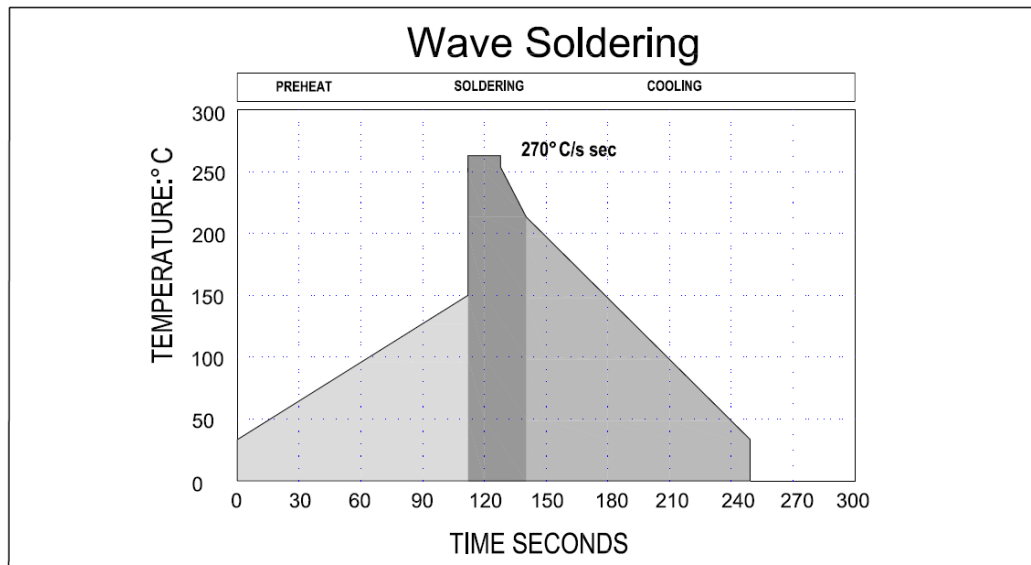

Maximum dwell time in the solder wave (270°C) shall not exceed 5 seconds.

Switch Operation and Taping

- (1) Use tweezers or ball-point pen for operation.
- (2) Flux cleaning should be done without removing the Tape.
- (3) If the tape is removed, it adheres less than before when it is placed back on, possibly causing flux inflow
- (4) Do Not Remove Tape sealed before Reflow processing
- (5) Ultrasonic cleaning not re-commended.

- ※ All switches must set in OFF position when through Soldering process.
- ※ Any flux enters the switch may influence contact function.

Materials:

- ◆ Cover BS/BS2F.....PBT (UL 94V-0), Blue / Red
 BSM.....HTN (UL 94V-0), Black
- ◆ Base BS/BS2F.....PA66 (UL 94V-0), Black
 BSM.....HTN (UL 94V-0), Black
- ◆ Actuator BS/BS2F.....PA66 (UL 94V-0), White
 BSM.....PA46 (UL 94V-0), White
- ◆ Contact Gold Plated
- ◆ Terminal 40u" +/-10u" Nickel Cover (Pure) Tin-Plated
 40u" +/-10u" Nickel Cover 1u" Gold-Plated
- ◆ Tape Polyester Film

BS

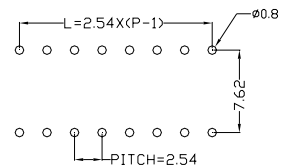
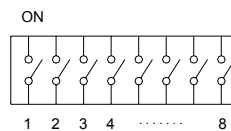
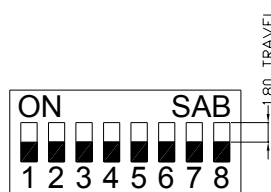
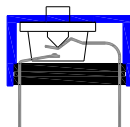
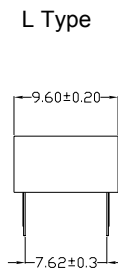
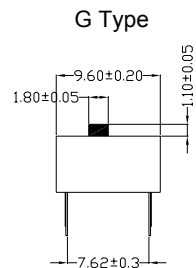
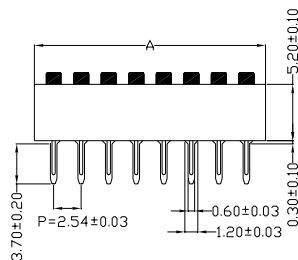

BS2F

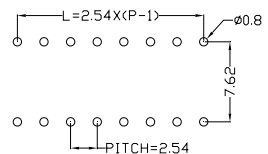
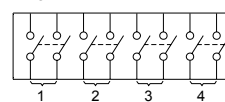
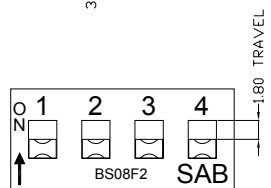
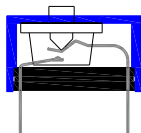
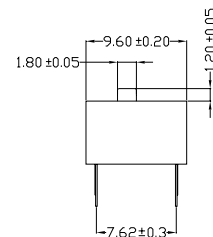
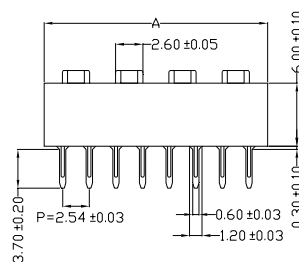

BSM

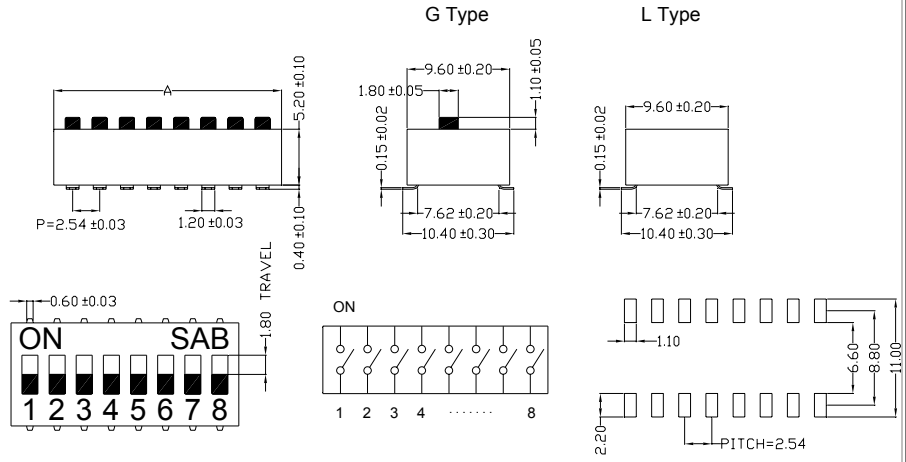
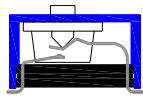
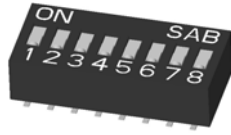

BSM2F

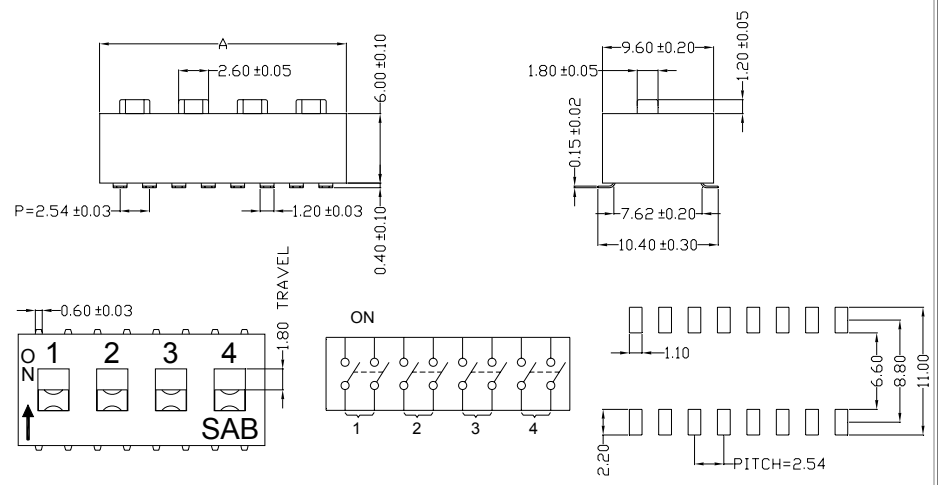
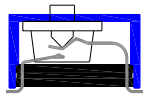

MODEL	SPECIFICATION RoHS Compliant DIP SWITCH	SP-007	Page
BS series Box Slide Type			7/8

Part Number Table:

BS/BSM

No. Pos.	Dim. "A"	Through Hole Raise Actuator Blue Tube Package	Raise Actuator 1u" Gold Lead Red Tube Package	SMD Raise Actuator Black Tube Package	Raise Actuator 1u" Gold Lead Black Tube Package
1	3.54	BS01GB	BS01G01R	BSM01GK	BSM01G01K
2	6.08	BS02GB	BS02G01R	BSM02GK	BSM02G01K
3	8.62	BS03GB	BS03G01R	BSM03GK	BSM03G01K
4	11.16	BS04GB	BS04G01R	BSM04GK	BSM04G01K
5	13.70	BS05GB	BS05G01R	BSM05GK	BSM05G01K
6	16.24	BS06GB	BS06G01R	BSM06GK	BSM06G01K
7	18.78	BS07GB	BS07G01R	BSM07GK	BSM07G01K
8	21.32	BS08GB	BS08G01R	BSM08GK	BSM08G01K
9	23.86	BS09GB	BS09G01R	BSM09GK	BSM09G01K
10	26.40	BS10GB	BS10G01R	BSM10GK	BSM10G01K
12	31.48	BS12GB	BS12G01R	BSM12GK	BSM12G01K

BS2F/BSM2F

No. Pos.	Dim. "A"	Through Hole Raise Actuator Red Tube Package	Raise Actuator 1u" Gold Lead Blue Tube Package	SMD Raise Actuator Black Tube Package	Raise Actuator 1u" Gold Lead Black Tube Package
1	6.08	BS2F01GR	BS2F01G01B	BSM2F01GK	BSM2F01G01K
2	11.16	BS2F02GR	BS2F02G01B	BSM2F02GK	BSM2F02G01K
3	16.24	BS2F03GR	BS2F03G01B	BSM2F03GK	BSM2F03G01K
4	21.32	BS2F04GR	BS2F04G01B	BSM2F04GK	BSM2F04G01K
5	26.40	BS2F05GR	BS2F05G01B	BSM2F05GK	BSM2F05G01K
6	31.48	BS2F06GR	BS2F06G01B	BSM2F06GK	BSM2F06G01K

Tube Package:

◆ **BS/BSM**

POLE	1	2	3	4	5	6	7	8	9	10	12
TUBE	144	85	61	47	38	32	28	24	22	20	16
BOX	11520	6800	4880	3760	3040	2560	2240	1920	1760	1600	1280
CTN 1	23040	13600	9760	7520	6080	5120	4480	3840	3520	3200	2560
CTN 2	46080	27200	19520	15040	12160	10240	8960	7680	7040	6400	5120

◆ **BS2F/BSM2F**

POLE	1	2	3	4	5	6
TUBE	85	47	32	24	20	16
BOX	6800	3760	2560	1920	1600	1280
CTN 1	13600	7520	5120	3840	3200	2560
CTN 2	27200	15040	10240	7680	6400	5120

BS/BSM

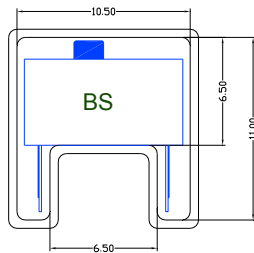

BS2F/BSM2F

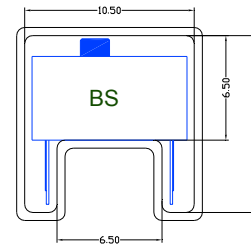

Box Dimension:

- ◆ Tube56cm × 12cm × 12cm

Carton Dimension:

- ◆ Tube CTN 1 / 2 Boxes.....58.5cm x 26.5cm x 16cm
- CTN 2 / 4 Boxes.....58.5cm x 26.5cm x 24cm