

Female Header
 Single Row - Straight DIP Type Pitch:1.27mm
 Dual Row - Straight DIP Type Pitch:1.27 x2.54mm

Series
 236
 246

woxconn
 Http://www.woxconn.com

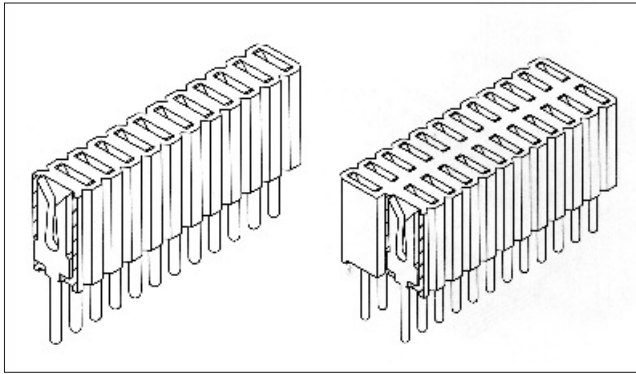

SPECIFICATIONS:

Current Rating: 1.0 AMP
 Contact Resistance: 30m• Max
 Insulation Resistance: 1000M• Min
 Withstand Voltage: 300VAC/minute
 Operation Temperature: -40°C to +105°C

MATERIALS:

Contact Material: Copper Alloy
 Contact Plating: Gold or Tin over 50μ " Ni
 Insulator Material: Polyester(UL94V-0)
 Standard: PA 46

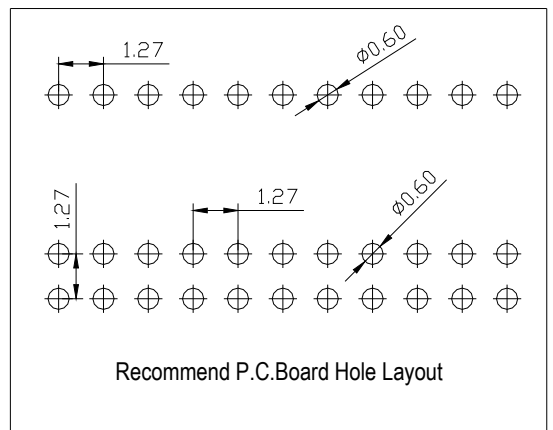
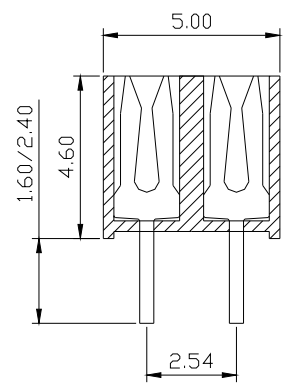
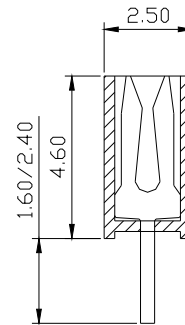
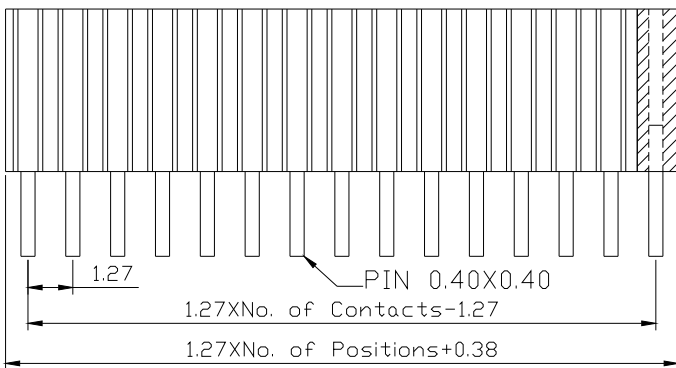
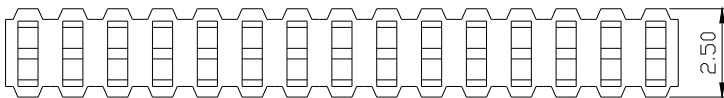
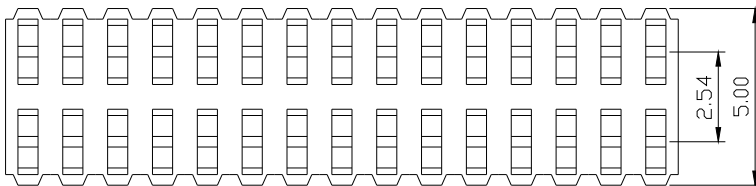

Ordering Code

① ② ③ ④ ⑤ ⑥ ⑦ ⑧ ⑨ ⑩
 2 X X X XX S X X 1 0

① Series No.:
 2= Female Header

② Pitch: 3= 1.27mm
 4 = 1.27 x 2.54mm

③ Insulator Height:
 6 = 4.6mm

④ Dip Spacing:
 1=Single row
 2=Double row

⑤ Number of Contacts:
 Single row =01 to 40
 Double row=02 to 80

⑥ Tail & Mounting Style:
 S=Straight DIP type

⑦ Contact Plated
 0=Tin
 1=Gold Flash
 2=Gold 3u"
 3=Gold 5u"
 4=Gold 10u"
 5=Gold 15u"
 6= Gold 30u"

⑧ Material Type
 0=PPS
 1=PBT
 2=LCP
 3=Nylon-66
 4=Nylon-6T
 5=PA46

⑨ Color:1=Black

⑩ Customer Request

Due to technical progress, all the information provided is subject to change without prior notice.