

Female Header
Single Row/ Dual Row
Bottom Entry

Pitch: 2.54 x Series
215

woxconn

[Http://www.woxconn.com](http://www.woxconn.com)

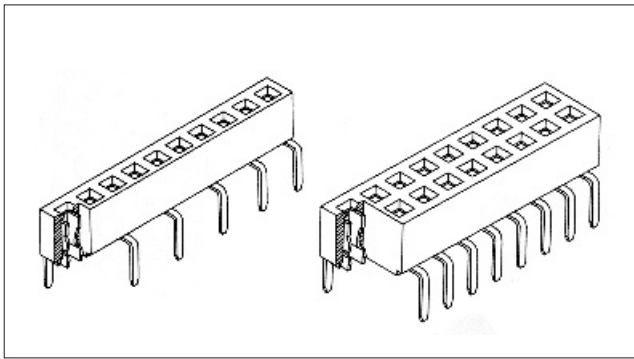

SPECIFICATIONS:

Current Rating: 3.0 AMP
Contact Resistance: 30m• Max
Insulation Resistance: 1000M• Min
Withstand Voltage: 600VAC/minute
Operation Temperature: -40°C to +105°C

MATERIALS:

Contact Material: Copper Alloy
Contact Plating: Gold or Tin over 50μ " Ni
Insulator: Glass Filled Polyester(UL94V-0)
Standard: PBT

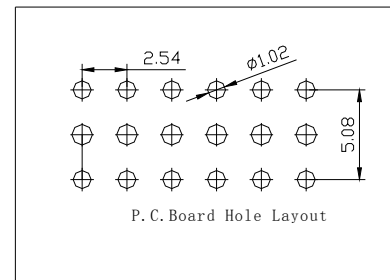
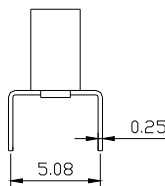
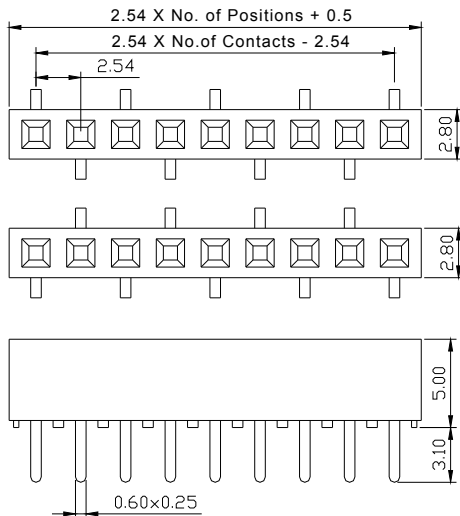
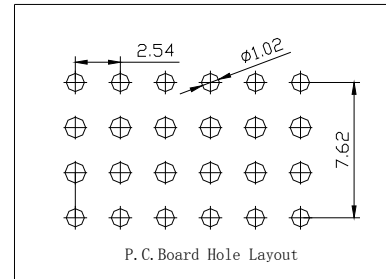
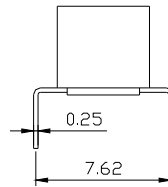
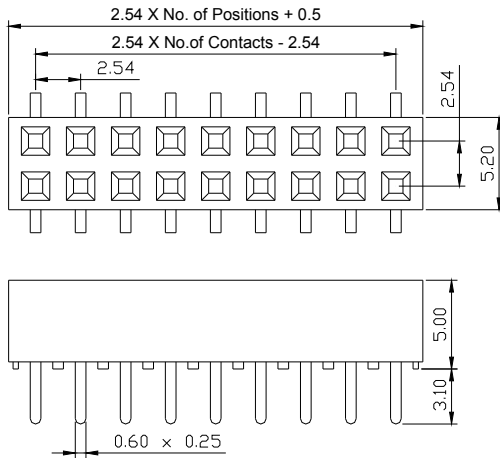

Ordering Code

① ② ③ ④ ⑤ ⑥ ⑦ ⑧ ⑨ ⑩
2 1 5 X XX B X X 1 0

① Series No. :
2= Female Header ③ Insulator Height:
5 = 5.0mm

② Pitch= 2.54mm

④ Dip Spacing:
1=Single row
2=Double row

⑤ Number of Contacts:
Single row=1 to 40
Double row=02 80

⑥ Tail & Mounting Style:
B=Bottom Entry

⑦ Contact Plated
0=Tin
1=Gold Flash
2=Gold 3u"
3=Gold 5u"
4=Gold 10u"
5=Gold 15u"
6= Gold 30u"

⑧ Material Type
0=PPS
1=PBT
2=LCP
3=Nylon-66
4=Nylon-6T
5=PA46

⑨ Color:1=Black

⑩ Customer Request