

15-20A DC/DC Power Modules

48V Input, (1.5V-1.8V-2.5V-3.3V-5V) Outputs

- *High efficiency 92% Typ (5V) at full load*
- *Fast dynamic response, 100 μ s,
 ± 150 mV_{peak} Typ*
- *Low output ripple, 60 mV_{p-p} Typ*
- *High power density, 44 W/in³ (5.0V)*
- *Wide input voltage range (36-75V)*
- *Industry standard footprint & pin-out*
- *1,500Vdc isolation voltage*
- *Max case temperature +100°C*
- *UL 1950/ULc 1950 Recognized*
- *TUV to EN60 950 Type Approved*



The PKM 4000 series represents a “third generation” of High Density DC/DC Power Modules in an industry standard quarter-brick package with unparalleled power densities and efficiencies. These breakthrough performance features have been achieved by using the most advanced patented topology, utilizing integrated magnetics and synchronous rectification on a low resistivity multilayer PCB. The product features fast dynamic response times and low output ripple, which are important parameters when supplying low voltage logics. The PKM 4000 series is especially suited for limited board space and high dynamic load applications such as demanding microprocessors.

Ericsson's PKM 4000 Power Modules address the converging “New Telecoms” market by specifying the input voltage range in accordance with ETSI specifications. The PKM 4000 series also offers over-voltage protection, under-voltage protection, over-temperature protection, soft-start, and is short circuit proof.

These products are manufactured using highly automated manufacturing lines with a world-class quality commitment and a five-year warranty. Ericsson Inc., Microelectronics has been an ISO 9001 certified supplier since 1991.

For a complete product program please reference the back page.

General

Absolute Maximum Ratings

Characteristics		min	max	Unit
T _C	Maximum Operating Case Temperature	-40	+100	°C
T _S	Storage temperature	-40	+125	°C
V _I	Input voltage	-0.5	+80	Vdc
V _{ISO}	Isolation voltage (input to output test voltage)	1,500		Vdc
V _{RC}	Remote control voltage		12	Vdc
I ² t	Inrush transient		1	A ² s

Input T_C < T_{Cmax}

Characteristics		Conditions		min	typ	max	Unit
V _I	Input voltage range			36		75	Vdc
V _{Ioff}	Turn-off input voltage	Ramping from higher voltage		31	33		Vdc
V _{Ion}	Turn-on input voltage	Ramping from lower voltage			34	36	Vdc
C _I	Input capacitance				1.5		µF
I _{lac}	Reflected ripple current	5 Hz to 20 MHz			10		mA p-p
I _{Imax}	Maximum input current	V _I = V _{I min}	75 W 100 W			1.8 2.3	A
P _{li}	Input idling power	I _o = 0			2.6	4.6	W
P _{RC}	Input stand-by power (turned off with RC)	V _I = 50V	RC open		0.4	0.6	W
VTRIM	Maximum input voltage on trim pin					6	Vdc

Environmental Characteristics

Characteristics	Test procedure & conditions		
Random Vibration	IEC 68-2-34F _c	Frequency Spectral density Duration	10...500 Hz 0.025 g ² /Hz 10 min in each direction
Sinusoidal Vibration	IEC 68-2-6 F _c	Frequency Amplitude Acceleration Number of cycles	10-500 Hz 0.75mm 10g 10 in each axis
Shock (half sinus)	IEC 68-2-27 E _a	Peak acceleration Duration	100 g 3ms
Temperature change	IEC 68-2-14 N _a	Temperature Number of cycles	-40°C...+100°C 300
Accelerated damp heat	IEC 68-2-3 C _a with bias	Temperature Humidity Duration	85°C 85% RH 1000 hours
Solder resistibility	IEC 68-2-20 T _b method IA	Temperature, solder Duration	260° C 10...13 s

Stress in excess of Absolute Maximum Ratings may cause permanent damage. Absolute Maximum Ratings, sometimes referred to as no destruction limits, are normally tested with one parameter at a time exceeding the limits of Output data or Electrical Characteristics.

If exposed to stress above these limits, function and performance may degrade in an unspecified manner. For design margin and to enhance system reliability, it is recommended that the PKM 4000 series DC/DC power modules are operated at case temperatures below 90°C.

Safety

The PKM 4000 Series DC/DC power modules are designed in accordance with EN 60 950, Safety of Information Technology Equipment Including Electrical Business Equipment and are TUV Type Approved.

The PKM 4000 DC/DC power modules are also recognized by UL and meet the applicable requirements in UL 1950, Safety of Information Technology Equipment and applicable Canadian safety requirements, i.e. UL_c 1950.

The isolation is an operational insulation in accordance with EN 60 950. The DC/DC power module should be installed in end-use equipment, in compliance with the requirements of the ultimate application, and is intended to be supplied by an isolated secondary circuit. Consideration should be given to measuring the case temperature to comply with T_{Cmax} when in operation.

When the supply to the DC/DC power module meets all the requirements for SELV (<60Vdc), the output is considered to remain within SELV limits (level 3). If connected to a 60V DC power system, reinforced insulation must be provided in the power supply that isolates the input from the mains. Single fault testing in the power supply must be performed in combination with the DC/DC power module to demonstrate that the output meets the requirement for SELV. One pole of the input and one pole of the output is to be grounded or both are to be kept floating.

Safety (continued)

The galvanic isolation is verified in an electric strength test. The test voltage (V_{ISO}) between input and output is 1,500 Vdc or 60 sec. Leakage current is less than 1 μ A @ 50Vdc.

Flammability ratings of the terminal support and internal plastic construction details meet UL 94V-0.

A fuse should be used at the input of each PKM 4000 series power module. If a fault occurs in the power module, that imposes a short on the input source, this fuse will provide the following two functions:

- Isolate the failed module from the input source so that the remainder of the system may continue operation.
- Protect the distribution wiring from overheating.

A fast blow fuse should be used with a rating of 10A or less. It is recommended to use a fuse with the lowest current rating, that is suitable for the application.

Mechanical Data

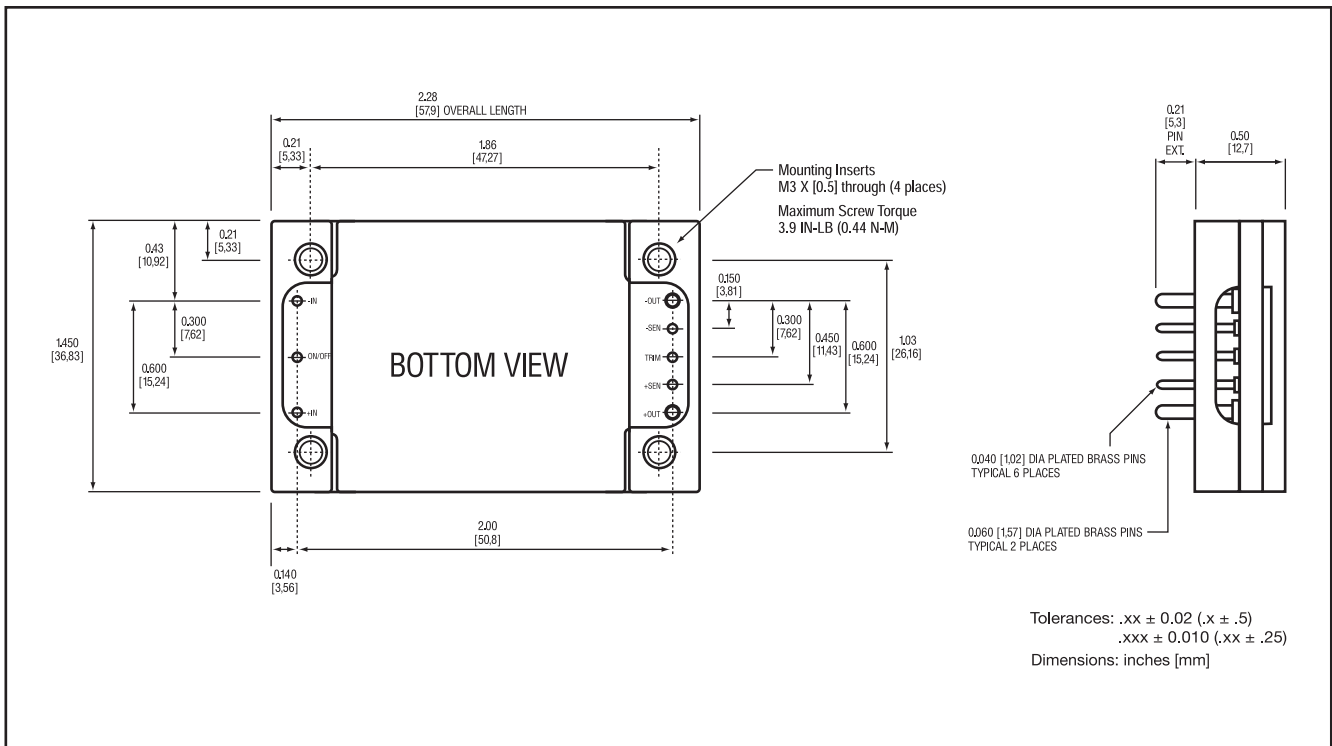

Connections

Designation	Function	Pin # (for ref.)
-IN	Negative input	1
ON/OFF	Remote control (primary). To turn-on and turn-off the output	2
+IN	Positive input	3
-OUT	Negative output	4
-SEN	Negative remote sense	5
Trim	Output voltage adjust	6
+SEN	Positive remote sense	7
+OUT	Positive output	8

Weight

55 grams

Case

Aluminum baseplate with metal standoffs.

Pins

Pin material: Brass

Pin plating: Tin/Lead over Nickel.

Thermal Data

The PKM 4000 series DC/DC power modules has a robust thermal design which allows operation at case (baseplate) temperatures (T_C) up to $+100^\circ\text{C}$. The main cooling mechanism is convection (free or forced) through the case or optional heatsinks.

The graphs below show the allowable maximum output current to maintain a maximum $+100^\circ\text{C}$ case temperature. Note that the ambient temperature is the air temperature adjacent to the power module which is typically elevated above the room environmental temperature.

Airflow Conversion Table

m/s	lfm
0.5	100
1.0	200
1.5	300
2.0	400
2.5	500
3.0	600

Note: Natural Convection average airflow speed can vary from 0.05 m/s to 0.2 m/s.

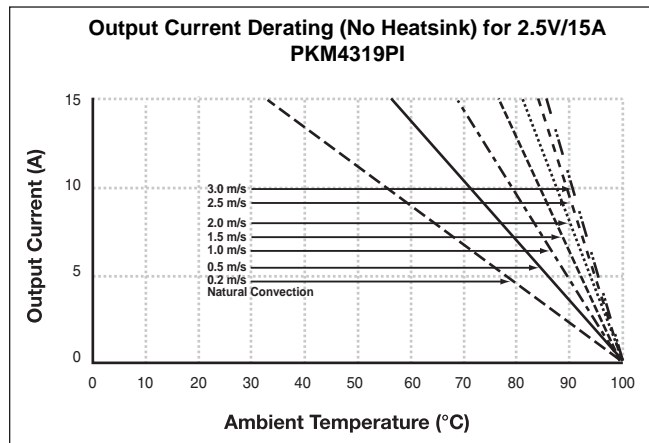
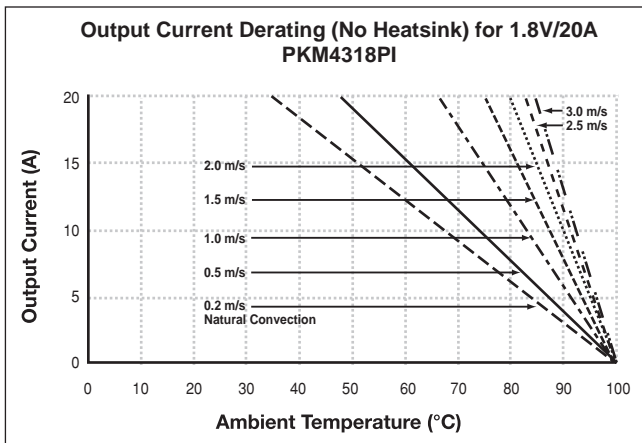
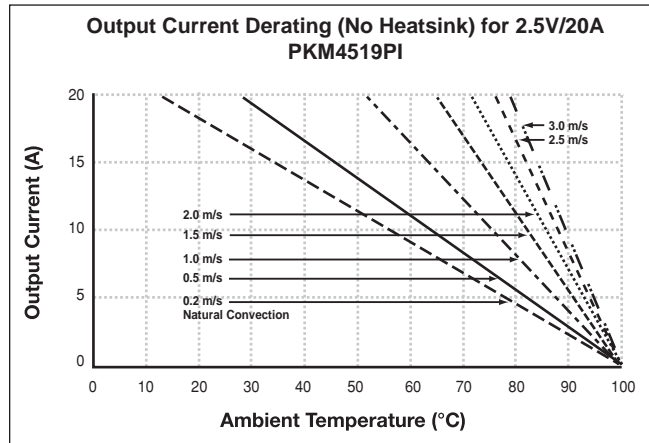
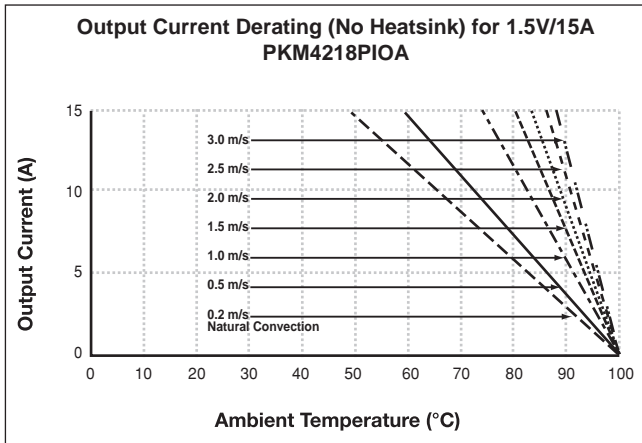
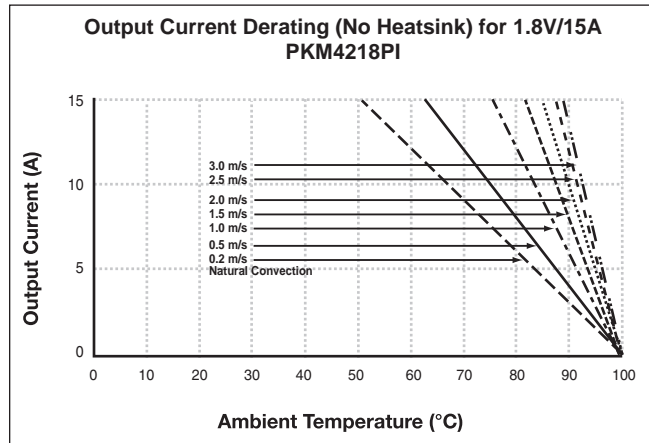
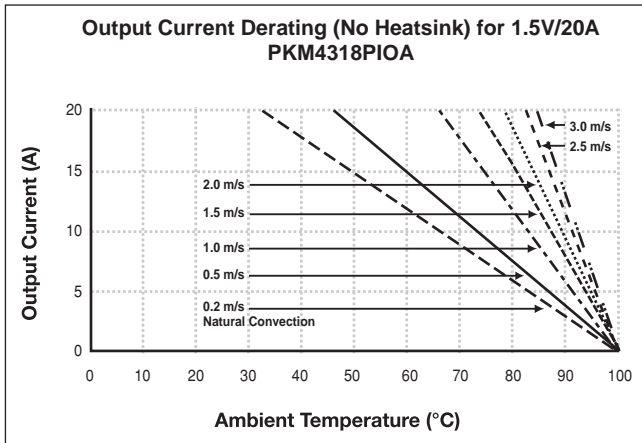

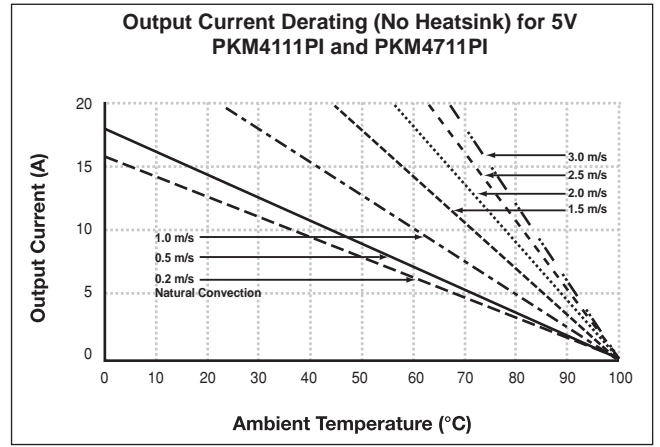
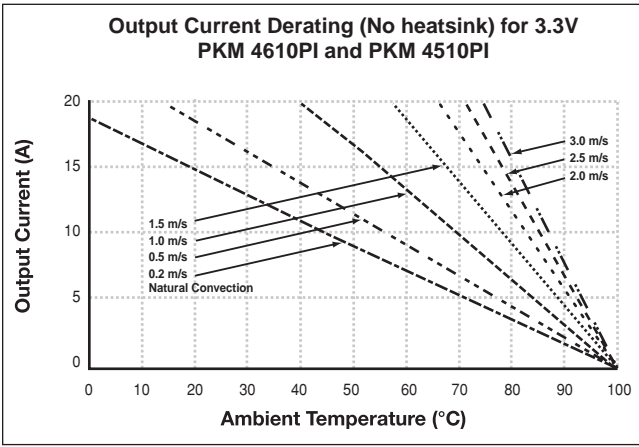

Thermal Data

The graphs below can be used to estimate case temperatures for given system operating conditions (see Thermal Design). For further information on optional heatsinks, please contact your local Ericsson sales office.

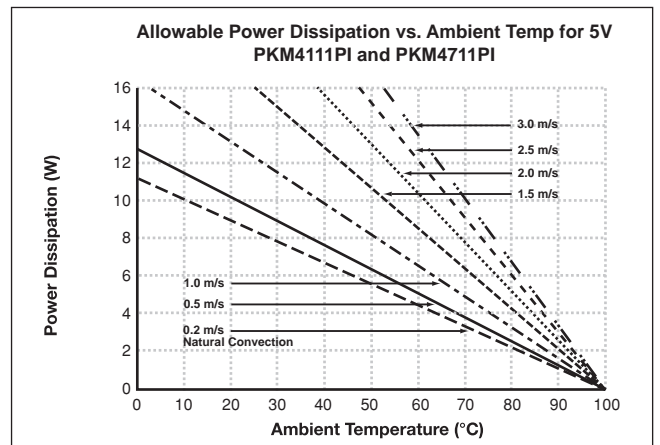
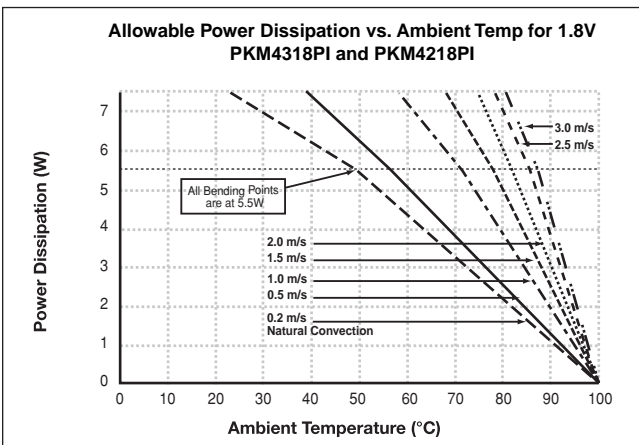
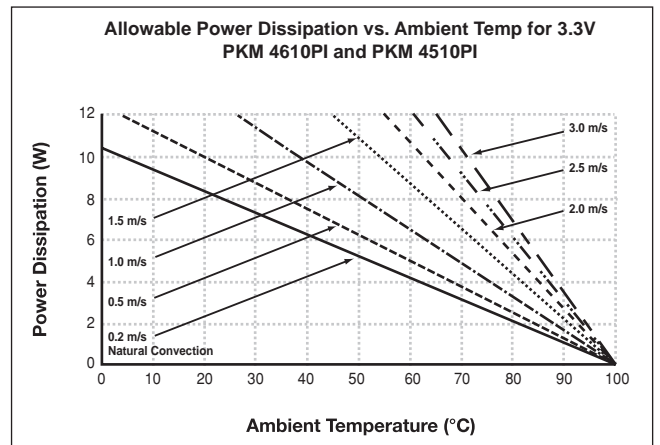
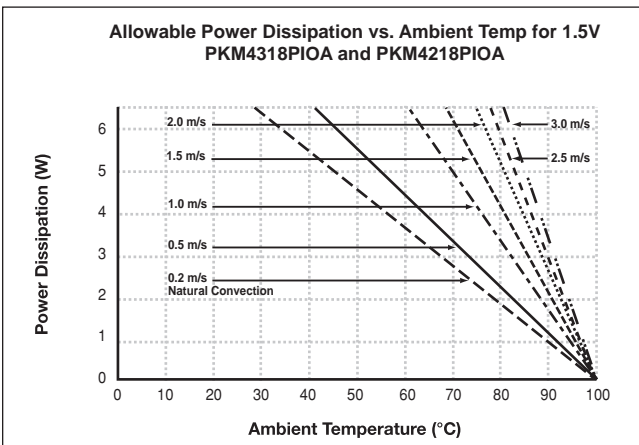
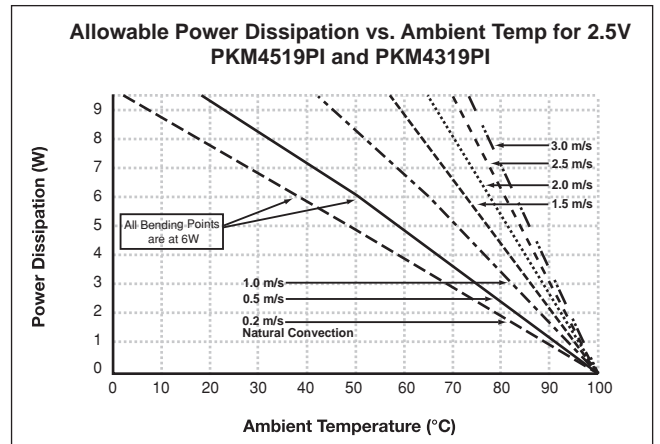

Note: For conversion from m/s to lfm please see conversion table on pg. 4.

Thermal Data

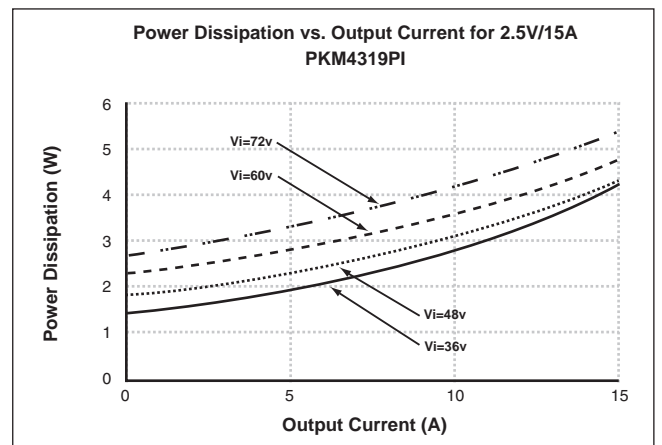
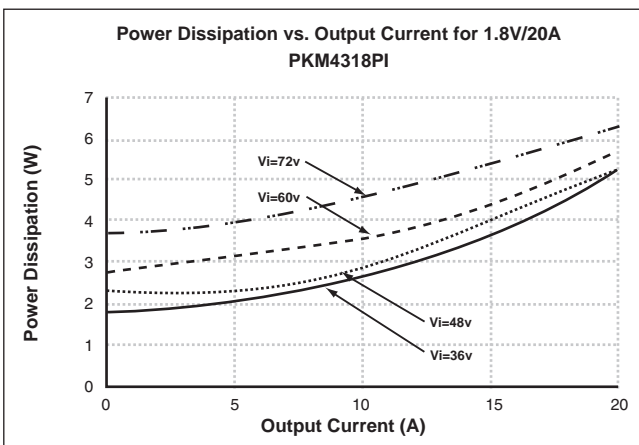
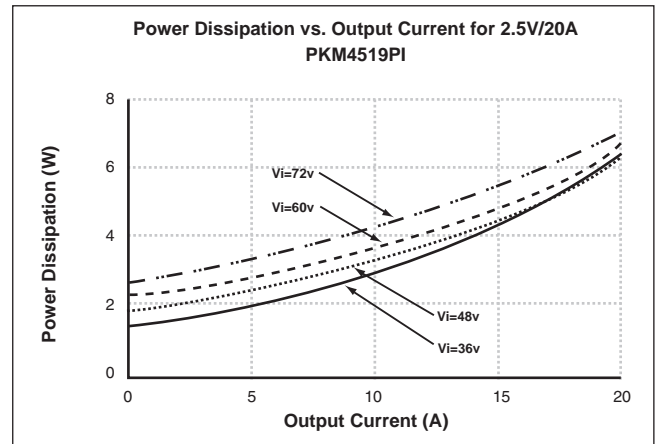
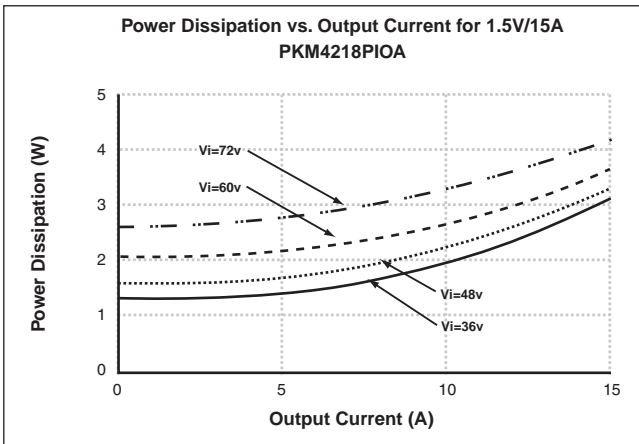
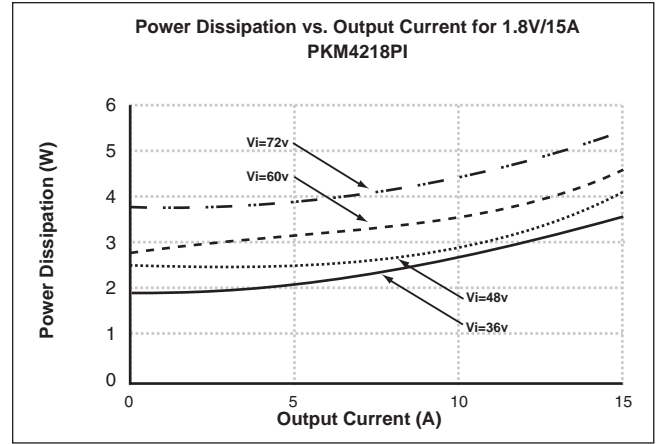
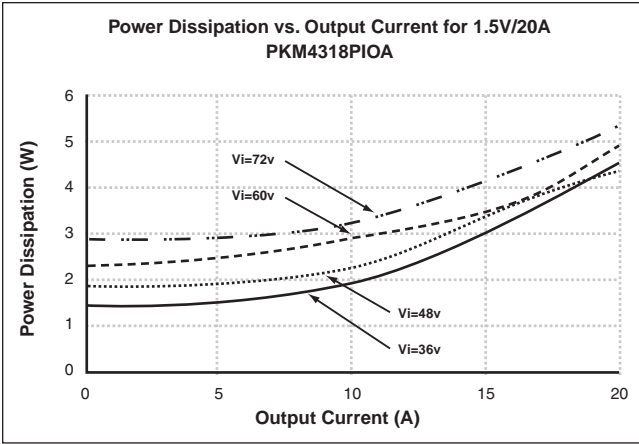

Thermal Data

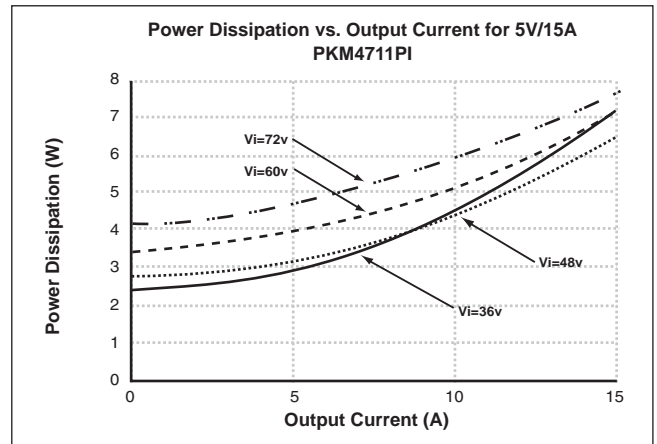
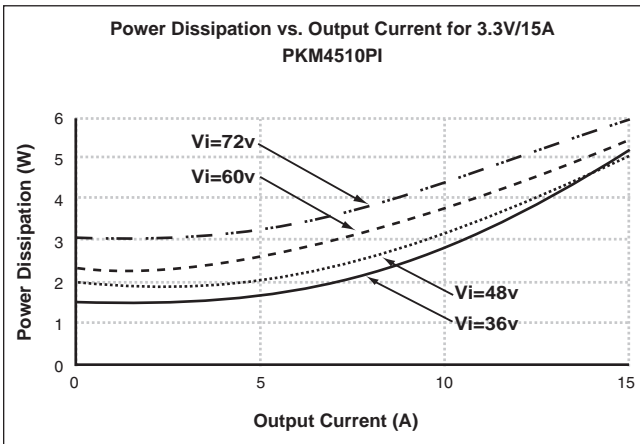
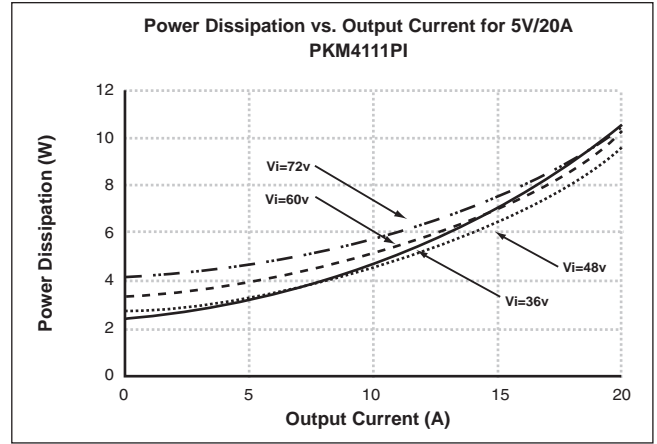
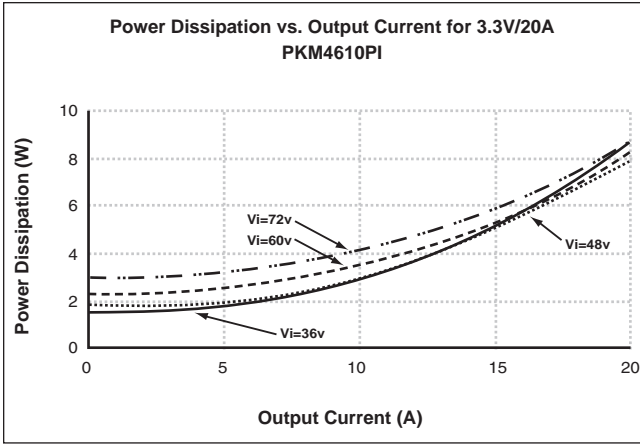

Thermal Design

The thermal data can be used to determine thermal performance without a heatsink.

Case temperature is calculated by the following formula:

$$T_C = T_A + P_d \times R_{th}^{C-A} \text{ (}^\circ\text{C/W)} \text{ where } P_d = P_O / (\eta - 1)$$

Where:

T_C : Case Temperature

T_A : Local Ambient Temperature

P_d : Dissipated Power

R_{th}^{C-A} : Thermal Resistance from T_C to T_A

P_O : Output Power

η : Efficiency

The efficiency η can be found in the tables on the following pages.

For design margin and to enhance system reliability, it is recommended that the PKM 4000 series DC/DC power modules are operated at case temperatures below 90°C.

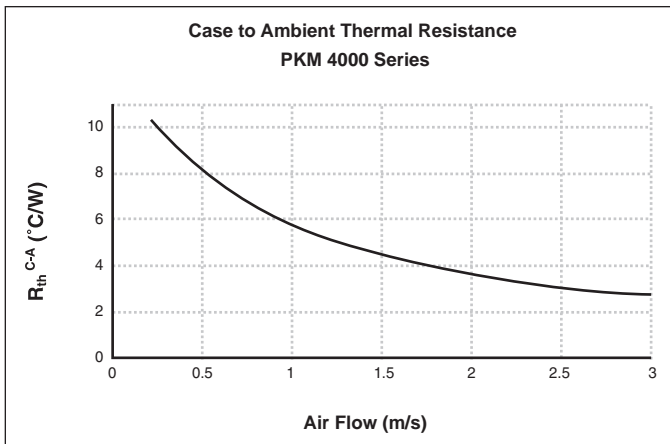

PKM 4318 PIOA (30W)

$T_C = -40...+100^{\circ}\text{C}$, $V_I = 36...75\text{V}$ dc unless otherwise specified.

Output

Characteristics		Conditions	Output			Unit
			min	typ	max	
V_{O_i}	Output voltage initial setting and accuracy	$T_C = +25^{\circ}\text{C}$, $V_I = 53\text{V}$, $I_O = I_{Omax}$	1.48	1.5	1.52	V
	Output adjust range	$I_O = 0$ to I_{Omax}	1.2		1.66	V
V_O	Output voltage tolerance band	$I_O = 0$ to I_{Omax}	1.43		1.58	V
	Line regulation	$I_O = I_{Omax}$		3	10	mV
	Load regulation	$V_I = 53\text{V}$, $I_O = 0$ to I_{Omax}		3	10	mV
V_{tr}	Load transient voltage deviation	Load step = $0.25 \times I_{Omax}$ $di/dt = 1\text{A}/\mu\text{s}$		± 150		mV_{peak}
t_{tr}	Load transient recovery time			100		μs
t_s	Start-up time	From V_I connection to $V_O = 0.9 \times V_{Onom}$		25	40	ms
I_O	Output current		0		20	A
P_{Omax}	Max output power	At $V_O = V_{Onom}$			30	W
I_{lim}	Current limit threshold	$V_O = 0.96 V_{Onom}$ @ $T_C < 100^{\circ}\text{C}$	21	24	26	A
I_{SC}	Short circuit current			24	28	A
V_{Oac}	Output ripple and noise	$I_O = I_{Omax}$ $f \leq 20$ MHz		70	150	mV_{p-p}
SVR	Supply voltage rejection (ac)	$f < 1\text{kHz}$	-53			dB
OVP	Over voltage protection	$V_{in} = 50\text{V}$	2.2	2.5	2.8	V

Miscellaneous

Characteristics		Conditions	min	typ	max	Unit
η	Efficiency	$T_A = +25^{\circ}\text{C}$, $V_I = 53\text{V}$, $I_O = I_{Omax}$		87		%
P_d	Power dissipation	$T_A = +25^{\circ}\text{C}$, $V_I = 53\text{V}$, $I_O = I_{Omax}$		4.5		W
f_O	Switching frequency	$I_O = 0...1.0 \times I_{Omax}$		200		kHz

PKM 4218 P10A (22.5W)

$T_C = -40...+100^{\circ}\text{C}$, $V_I = 36...75\text{V}$ dc unless otherwise specified.

Output

Characteristics		Conditions	Output			Unit
			min	typ	max	
V_{O_i}	Output voltage initial setting and accuracy	$T_C = +25^{\circ}\text{C}$, $V_I = 53\text{V}$, $I_O = I_{O_{\text{max}}}$	1.48	1.5	1.52	V
	Output adjust range	$I_O = 0$ to $I_{O_{\text{max}}}$	1.2		1.66	V
V_O	Output voltage tolerance band	$I_O = 0$ to $I_{O_{\text{max}}}$	1.43		1.58	V
	Line regulation	$I_O = I_{O_{\text{max}}}$		3	10	mV
	Load regulation	$V_I = 53\text{V}$, $I_O = 0$ to $I_{O_{\text{max}}}$		3	10	mV
V_{tr}	Load transient voltage deviation	Load step = $0.25 \times I_{O_{\text{max}}}$ $dI/dt = 1\text{A}/\mu\text{s}$		± 150		mV_{peak}
t_{tr}	Load transient recovery time			100		μs
t_s	Start-up time	From V_I connection to $V_O = 0.9 \times V_{O_{\text{nom}}}$		25	40	ms
I_O	Output current		0		15	A
$P_{O_{\text{max}}}$	Max output power	At $V_O = V_{O_{\text{nom}}}$			22.5	W
I_{lim}	Current limit threshold	$V_O = 0.96 V_{O_{\text{nom}}}$ @ $T_C < 100^{\circ}\text{C}$	16	18	21	A
I_{SC}	Short circuit current			20	23	A
$V_{O_{\text{ac}}}$	Output ripple and noise	$I_O = I_{O_{\text{max}}}$ $f \leq 20$ MHz		70	150	$\text{mV}_{\text{p-p}}$
SVR	Supply voltage rejection (ac)	$f < 1\text{kHz}$	-53			dB
OVP	Over voltage protection	$V_{\text{in}} = 50\text{V}$	2.2	2.5	2.8	V

Miscellaneous

Characteristics		Conditions	min	typ	max	Unit
η	Efficiency	$T_A = +25^{\circ}\text{C}$, $V_I = 53\text{V}$, $I_O = I_{O_{\text{max}}}$		87		%
P_d	Power dissipation	$T_A = +25^{\circ}\text{C}$, $V_I = 53\text{V}$, $I_O = I_{O_{\text{max}}}$		3.4		W
f_o	Switching frequency	$I_O = 0...1.0 \times I_{O_{\text{max}}}$		200		kHz

PKM 4318 PI (36W)

$T_C = -40...+100^{\circ}\text{C}$, $V_I = 36...75\text{V}$ dc unless otherwise specified.

Output

Characteristics		Conditions	Output			Unit
			min	typ	max	
V_{O_i}	Output voltage initial setting and accuracy	$T_C = +25^{\circ}\text{C}$, $V_I = 53\text{V}$, $I_O = I_{Omax}$	1.77	1.8	1.83	V
	Output adjust range	$I_O = 0$ to I_{Omax}	1.44		2.0	V
V_O	Output voltage tolerance band	$I_O = 0$ to I_{Omax}	1.71		1.89	V
	Line regulation	$I_O = I_{Omax}$		3	10	mV
	Load regulation	$V_I = 53\text{V}$, $I_O = 0$ to I_{Omax}		3	10	mV
V_{tr}	Load transient voltage deviation	Load step = $0.25 \times I_{Omax}$ $di/dt = 1\text{A}/\mu\text{s}$		± 150		mV _{peak}
t_{tr}	Load transient recovery time			100		μs
t_s	Start-up time	From V_I connection to $V_O = 0.9 \times V_{Onom}$		25	40	ms
I_O	Output current		0		20	A
P_{Omax}	Max output power	At $V_O = V_{Onom}$			36	W
I_{lim}	Current limit threshold	$V_O = 0.96 V_{Onom}$ @ $T_C < 100^{\circ}\text{C}$	21	24	26	A
I_{SC}	Short circuit current			24	28	A
V_{Oac}	Output ripple and noise	$I_O = I_{Omax}$ $f \leq 20$ MHz		70	150	mVp-p
SVR	Supply voltage rejection (ac)	$f < 1\text{kHz}$	-53			dB
OVP	Over voltage protection	$V_{in} = 50\text{V}$	2.5	2.8	3.0	V

Miscellaneous

Characteristics		Conditions	min	typ	max	Unit
η	Efficiency	$T_A = +25^{\circ}\text{C}$, $V_I = 53\text{V}$, $I_O = I_{Omax}$		88		%
P_d	Power dissipation	$T_A = +25^{\circ}\text{C}$, $V_I = 53\text{V}$, $I_O = I_{Omax}$		4.9		W
f_O	Switching frequency	$I_O = 0...1.0 \times I_{Omax}$		200		kHz

PKM 4218 PI (27W)

$T_C = -40...+100^{\circ}\text{C}$, $V_I = 36...75\text{V}$ dc unless otherwise specified.

Output

Characteristics		Conditions	Output			Unit
			min	typ	max	
V_{O_i}	Output voltage initial setting and accuracy	$T_C = +25^{\circ}\text{C}$, $V_I = 53\text{V}$, $I_O = I_{Omax}$	1.77	1.8	1.83	V
	Output adjust range	$I_O = 0$ to I_{Omax}	1.44		2.0	V
V_O	Output voltage tolerance band	$I_O = 0$ to I_{Omax}	1.71		1.89	V
	Line regulation	$I_O = I_{Omax}$		3	10	mV
	Load regulation	$V_I = 53\text{V}$, $I_O = 0$ to I_{Omax}		3	10	mV
V_{tr}	Load transient voltage deviation	Load step = $0.25 \times I_{Omax}$ $di/dt = 1\text{A}/\mu\text{s}$		± 150		mV _{peak}
t_{tr}	Load transient recovery time			100		μs
t_s	Start-up time	From V_I connection to $V_O = 0.9 \times V_{Onom}$		25	40	ms
I_O	Output current		0		15	A
P_{Omax}	Max output power	At $V_O = V_{Onom}$			27	W
I_{lim}	Current limit threshold	$V_O = 0.96 V_{Onom}$ @ $T_C < 100^{\circ}\text{C}$	16	18	21	A
I_{SC}	Short circuit current			24	28	A
V_{Oac}	Output ripple and noise	$I_O = I_{Omax}$ $f \leq 20$ MHz		70	150	mVp-p
SVR	Supply voltage rejection (ac)	$f < 1\text{kHz}$	-53			dB
OVP	Over voltage protection	$V_{in} = 50\text{V}$	2.5	2.8	3.0	V

Miscellaneous

Characteristics		Conditions	min	typ	max	Unit
η	Efficiency	$T_A = +25^{\circ}\text{C}$, $V_I = 53\text{V}$, $I_O = I_{Omax}$		89		%
P_d	Power dissipation	$T_A = +25^{\circ}\text{C}$, $V_I = 53\text{V}$, $I_O = I_{Omax}$		3.3		W
f_o	Switching frequency	$I_O = 0...1.0 \times I_{Omax}$		200		kHz

PKM 4519 PI (50W)

$T_C = -40...+100^{\circ}\text{C}$, $V_I = 36...75\text{V}$ dc unless otherwise specified.

Output

Characteristics		Conditions	Output			Unit
			min	typ	max	
V_{O_i}	Output voltage initial setting and accuracy	$T_C = +25^{\circ}\text{C}$, $V_I = 53\text{V}$, $I_O = I_{O_{\text{max}}}$	2.45	2.5	2.55	V
	Output adjust range	$I_O = 0$ to $I_{O_{\text{max}}}$	2.0		2.75	V
V_O	Output voltage tolerance band	$I_O = 0$ to $I_{O_{\text{max}}}$	2.4		2.6	V
	Line regulation	$I_O = I_{O_{\text{max}}}$		3	10	mV
	Load regulation	$V_I = 53\text{V}$, $I_O = 0$ to $I_{O_{\text{max}}}$		3	10	mV
V_{tr}	Load transient voltage deviation	Load step = $0.25 \times I_{O_{\text{max}}}$ $di/dt = 1\text{A}/\mu\text{s}$		± 150		mV _{peak}
t_{tr}	Load transient recovery time			100		μs
t_s	Start-up time	From V_I connection to $V_O = 0.9 \times V_{O_{\text{nom}}}$		25	40	ms
I_O	Output current		0		20	A
$P_{O_{\text{max}}}$	Max output power	At $V_O = V_{O_{\text{nom}}}$			50	W
I_{lim}	Current limit threshold	$V_O = 0.96 V_{O_{\text{nom}}}$ @ $T_C < 100^{\circ}\text{C}$	21	24	26	A
I_{SC}	Short circuit current			26	30	A
$V_{O_{\text{ac}}}$	Output ripple and noise	$I_O = I_{O_{\text{max}}}$ $f \leq 20$ MHz		60	100	mVp-p
SVR	Supply voltage rejection (ac)	$f < 1\text{kHz}$	-53			dB
OVP	Over voltage protection	$V_{\text{in}} = 50\text{V}$	3.2	3.7	4.2	V

Miscellaneous

Characteristics		Conditions	min	typ	max	Unit
η	Efficiency	$T_A = +25^{\circ}\text{C}$, $V_I = 53\text{V}$, $I_O = I_{O_{\text{max}}}$		89		%
P_d	Power dissipation	$T_A = +25^{\circ}\text{C}$, $V_I = 53\text{V}$, $I_O = I_{O_{\text{max}}}$		6.2		W
f_o	Switching frequency	$I_O = 0...1.0 \times I_{O_{\text{max}}}$		200		kHz

PKM 4319 PI (37.5W)

$T_C = -40...+100^{\circ}\text{C}$, $V_I = 36...75\text{V}$ dc unless otherwise specified.

Output

Characteristics		Conditions	Output			Unit
			min	typ	max	
V_{O_i}	Output voltage initial setting and accuracy	$T_C = +25^{\circ}\text{C}$, $V_I = 53\text{V}$, $I_O = I_{Omax}$	2.45	2.5	2.55	V
	Output adjust range	$I_O = 0$ to I_{Omax}	2.0		2.75	V
V_O	Output voltage tolerance band	$I_O = 0$ to I_{Omax}	2.4		2.6	V
	Line regulation	$I_O = I_{Omax}$		3	10	mV
	Load regulation	$V_I = 53\text{V}$, $I_O = 0$ to I_{Omax}		3	10	mV
V_{tr}	Load transient voltage deviation	Load step = $0.25 \times I_{Omax}$ $dl/dt = 1\text{A}/\mu\text{s}$		± 150		mV_{peak}
t_{tr}	Load transient recovery time			100		μs
t_s	Start-up time	From V_I connection to $V_O = 0.9 \times V_{Onom}$		25	40	ms
I_O	Output current		0		15	A
P_{Omax}	Max output power	At $V_O = V_{Onom}$			37.5	W
I_{lim}	Current limit threshold	$V_O = 0.96 V_{Onom}$ @ $T_C < 100^{\circ}\text{C}$	16	18	21	A
I_{SC}	Short circuit current			26	30	A
V_{Oac}	Output ripple and noise	$I_O = I_{Omax}$ $f \leq 20$ MHz		60	100	mVp-p
SVR	Supply voltage rejection (ac)	$f < 1\text{kHz}$	-53			dB
OVP	Over voltage protection	$V_{in} = 50\text{V}$	3.2	3.7	4.2	V

Miscellaneous

Characteristics		Conditions	min	typ	max	Unit
η	Efficiency	$T_A = +25^{\circ}\text{C}$, $V_I = 53\text{V}$, $I_O = I_{Omax}$		89		%
P_d	Power dissipation	$T_A = +25^{\circ}\text{C}$, $V_I = 53\text{V}$, $I_O = I_{Omax}$		4.6		W
f_O	Switching frequency	$I_O = 0...1.0 \times I_{Omax}$		200		kHz

PKM 4610 PI (66W)

$T_C = -40...+100^{\circ}\text{C}$, $V_I = 36...75\text{V}$ dc unless otherwise specified.

Output

Characteristics		Conditions		Output			Unit
				min	typ	max	
V_{O_i}	Output voltage initial setting and accuracy	$T_C = +25^{\circ}\text{C}$, $V_I = 53\text{V}$, $I_O = I_{Omax}$		3.25	3.30	3.35	V
	Output adjust range	$I_O = 0$ to I_{Omax}		2.64		3.63	V
V_O	Output voltage tolerance band	$I_O = 0$ to I_{Omax}		3.2		3.4	V
	Line regulation	$I_O = I_{Omax}$			3	10	mV
	Load regulation	$V_I = 53\text{V}$, $I_O = 0$ to I_{Omax}			3	10	mV
V_{tr}	Load transient voltage deviation	Load step = $0.25 \times I_{Omax}$ $di/dt = 1\text{A}/\mu\text{s}$			± 150		mVpeak
t_{tr}	Load transient recovery time				100		μs
t_s	Start-up time	From V_I connection to $V_O = 0.9 \times V_{Onom}$			25	40	ms
I_O	Output current			0		20	A
P_{Omax}	Max output power	At $V_O = V_{Onom}$				66	W
I_{lim}	Current limit threshold	$V_O = 0.90 \times V_{Onom}$ @ $T_C < 100^{\circ}\text{C}$		21	24	26	A
I_{SC}	Short circuit current				24	28	A
V_{Oac}	Output ripple and noise	$I_O = I_{Omax}$	$f < 20\text{ MHz}$		60	100	mVp-p
SVR	Supply voltage rejection	$f < 1\text{ kHz}$		-53			dB
OVP	Overvoltage protection	$V_I = 53\text{V}$		3.9	4.4	5.0	V

Miscellaneous

Characteristics		Conditions		min	typ	max	Unit
η	Efficiency	$T_A = +25^{\circ}\text{C}$, $V_I = 53\text{V}$, $I_O = I_{Omax}$			89		%
P_d	Power dissipation	$T_A = +25^{\circ}\text{C}$, $V_I = 53\text{V}$, $I_O = I_{Omax}$			8.2		W
f_o	Switching frequency	$I_O = 0...1.0 \times I_{Omax}$			150		kHz

PKM 4510 PI (50W)

$T_C = -40...+100^{\circ}\text{C}$, $V_I = 36...75\text{V}$ dc unless otherwise specified.

Output

Characteristics		Conditions		Output			Unit
				min	typ	max	
V_{O_i}	Output voltage initial setting and accuracy	$T_C = +25^{\circ}\text{C}$, $V_I = 53\text{V}$, $I_O = I_{Omax}$		3.25	3.30	3.35	V
	Output adjust range	$I_O = 0$ to I_{Omax}		2.64		3.63	V
V_O	Output voltage tolerance band	$I_O = 0$ to I_{Omax}		3.2		3.4	V
	Line regulation	$I_O = I_{Omax}$			3	10	mV
	Load regulation	$V_I = 53\text{V}$, $I_O = 0$ to I_{Omax}			3	10	mV
V_{tr}	Load transient voltage deviation	Load step = $0.25 \times I_{Omax}$ $dI/dt = 1\text{A}/\mu\text{s}$			± 150		mVpeak
t_{tr}	Load transient recovery time				100		μs
t_s	Start-up time	From V_I connection to $V_O = 0.9 \times V_{Onom}$			25	40	ms
I_O	Output current			0		15	A
P_{Omax}	Max output power	At $V_O = V_{Onom}$				50	W
I_{lim}	Current limit threshold	$V_O = 0.90 \times V_{Onom}$ @ $T_C < 100^{\circ}\text{C}$		16	18	21	A
I_{SC}	Short circuit current				20	23	A
V_{Oac}	Output ripple and noise	$I_O = I_{Omax}$	$f < 20\text{ MHz}$		60	100	mVp-p
SVR	Supply voltage rejection	$f < 1\text{ kHz}$		-53			dB
OVP	Overvoltage protection	$V_I = 53\text{V}$		3.9	4.4	5.0	V

Miscellaneous

Characteristics		Conditions		min	typ	max	Unit
η	Efficiency	$T_A = +25^{\circ}\text{C}$, $V_I = 53\text{V}$, $I_O = I_{Omax}$			91		%
P_d	Power dissipation	$T_A = +25^{\circ}\text{C}$, $V_I = 53\text{V}$, $I_O = I_{Omax}$			4.9		W
f_O	Switching frequency	$I_O = 0...1.0 \times I_{Omax}$			150		kHz

PKM 4111 PI (100W)

$T_C = -40...+100^{\circ}\text{C}$, $V_I = 36...75\text{V}$ dc unless otherwise specified.

Output

Characteristics		Conditions	Output			Unit
			min	typ	max	
V_{O_i}	Output voltage initial setting and accuracy	$T_C = +25^{\circ}\text{C}$, $V_I = 53\text{V}$, $I_O = I_{Omax}$	4.9	5.0	5.1	V
	Output adjust range	$I_O = 0$ to I_{Omax} , $V_I = 38...75\text{V}$ dc	4.0		5.5	V
V_O	Output voltage tolerance band	$I_O = 0$ to I_{Omax}	4.85		5.15	V
	Line regulation	$V_I = 38...75\text{V}$, $I_O = I_{Omax}$		3	10	mV
	Load regulation	$V_I = 53\text{V}$, $I_O = 0$ to I_{Omax}		3	10	mV
V_{tr}	Load transient voltage deviation	Load step = $0.25 \times I_{Omax}$ $di/dt = 1\text{A}/\mu\text{s}$		± 150		mV_{peak}
t_{tr}	Load transient recovery time			200		μs
t_s	Start-up time	From V_I connection to $V_O = 0.9 \times V_{Onom}$		60	90	ms
I_O	Output current		0		20	A
P_{Omax}	Max output power	At $V_O = V_{Onom}$			100	W
I_{lim}	Current limit threshold	$V_O = 0.96 V_{Onom}$ @ $T_C < 100^{\circ}\text{C}$	21	24	26	A
I_{SC}	Short circuit current			24	28	A
V_{Oac}	Output ripple and noise	$I_O = I_{Omax}$ $f \leq 20$ MHz		85	150	mV_{p-p}
SVR	Supply voltage rejection (ac)	$f < 1\text{kHz}$	-53			dB
OVP	Over voltage protection	$V_{in} = 50\text{V}$	5.8	6.2	6.5	V

Miscellaneous

Characteristics		Conditions	min	typ	max	Unit
η	Efficiency	$T_A = +25^{\circ}\text{C}$, $V_I = 53\text{V}$, $I_O = I_{Omax}$		90		%
P_d	Power dissipation	$T_A = +25^{\circ}\text{C}$, $V_I = 53\text{V}$, $I_O = I_{Omax}$		11.1		W
f_O	Switching frequency	$I_O = 0...1.0 \times I_{Omax}$		200		kHz

PKM 4711 PI (75W)

$T_C = -40...+100^{\circ}\text{C}$, $V_I = 36...75\text{V}$ dc unless otherwise specified.

Output

Characteristics		Conditions	Output			Unit
			min	typ	max	
V_{O_i}	Output voltage initial setting and accuracy	$T_C = +25^{\circ}\text{C}$, $V_I = 53\text{V}$, $I_O = I_{Omax}$	4.9	5.0	5.1	V
	Output adjust range	$I_O = 0$ to I_{Omax} , $V_I = 38...75\text{V}$ dc	4.0		5.5	V
V_O	Output voltage tolerance band	$I_O = 0$ to I_{Omax}	4.85		5.15	V
	Line regulation	$V_I = 38...75\text{V}$, $I_O = I_{Omax}$		3	10	mV
	Load regulation	$V_I = 53\text{V}$, $I_O = 0$ to I_{Omax}		3	10	mV
V_{tr}	Load transient voltage deviation	Load step = $0.25 \times I_{Omax}$ $di/dt = 1\text{A}/\mu\text{s}$		± 150		mV_{peak}
t_{tr}	Load transient recovery time			200		μs
t_s	Start-up time	From V_I connection to $V_O = 0.9 \times V_{Onom}$		60	90	ms
I_O	Output current		0		15	A
P_{Omax}	Max output power	At $V_O = V_{Onom}$			75	W
I_{lim}	Current limit threshold	$V_O = 0.96 V_{Onom}$ @ $T_C < 100^{\circ}\text{C}$	16	18	21	A
I_{SC}	Short circuit current			24	28	A
V_{Oac}	Output ripple and noise	$I_O = I_{Omax}$ $f \leq 20$ MHz		85	150	mVp-p
SVR	Supply voltage rejection (ac)	$f < 1\text{kHz}$	-53			dB
OVP	Over voltage protection	$V_{in} = 50\text{V}$	5.8	6.2	6.5	V

Miscellaneous

Characteristics		Conditions	min	typ	max	Unit
η	Efficiency	$T_A = +25^{\circ}\text{C}$, $V_I = 53\text{V}$, $I_O = I_{Omax}$		92		%
P_d	Power dissipation	$T_A = +25^{\circ}\text{C}$, $V_I = 53\text{V}$, $I_O = I_{Omax}$		6.5		W
f_o	Switching frequency	$I_O = 0...1.0 \times I_{Omax}$		200		kHz

PKM 4318 PIOA (30W)

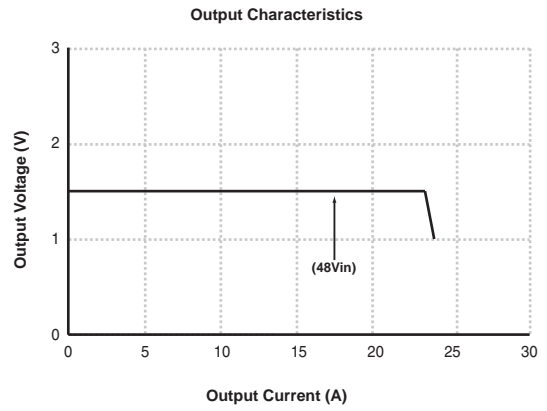
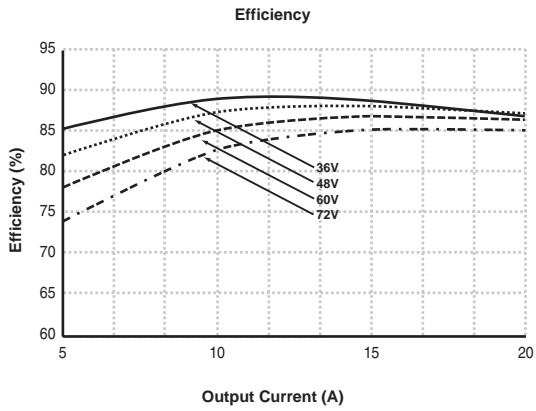

PKM 4218 PIOA (22.5W)

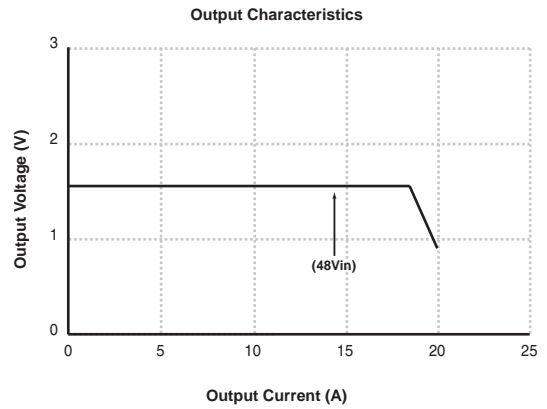
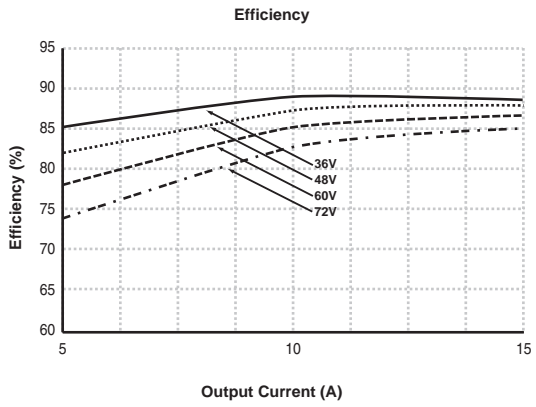

PKM 4318 PI (36W)

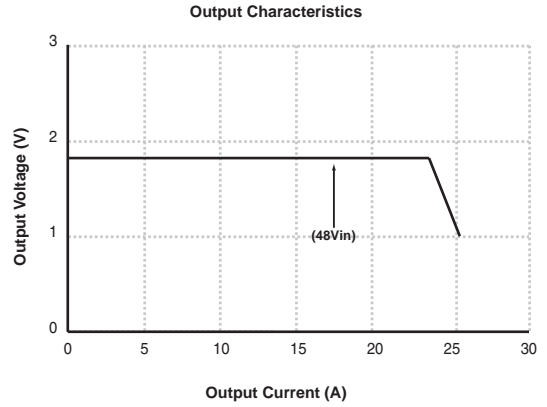
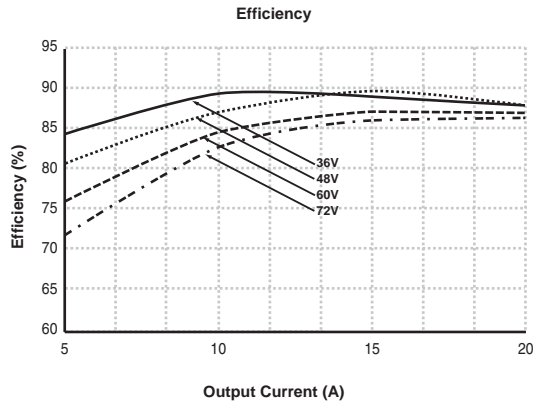

PKM 4218 PI (27W)

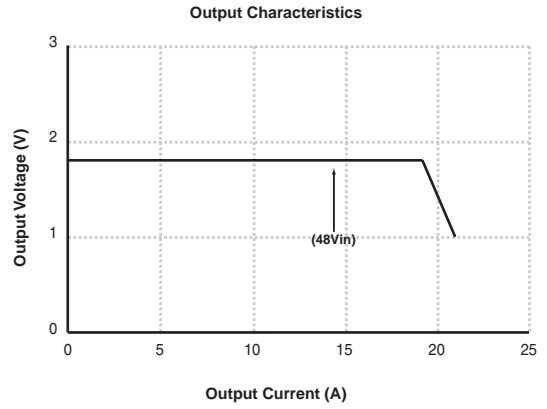
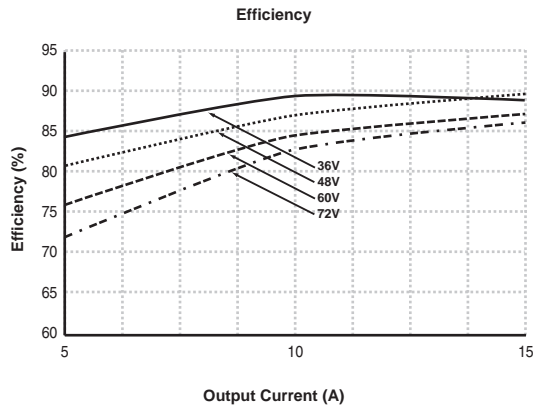

PKM 4519 (50W)

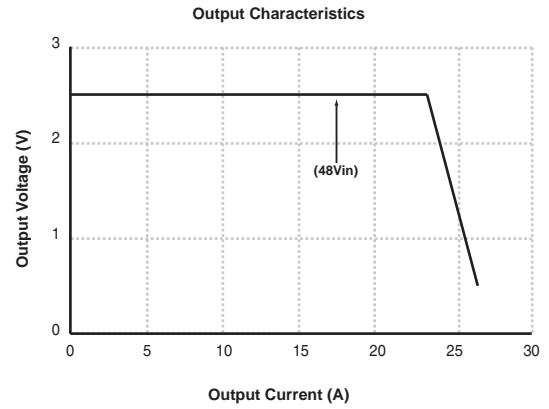
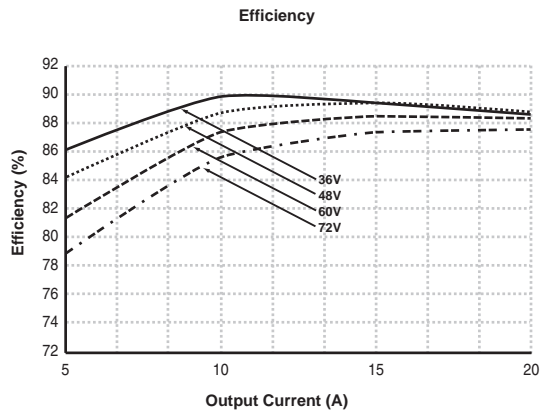

PKM 4319 PI (37.5W)

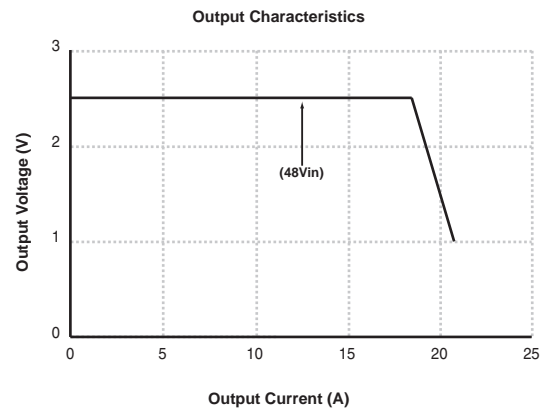
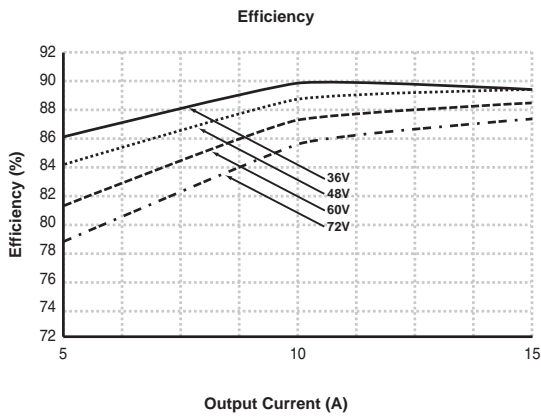

PKM 4610 PI (66W)

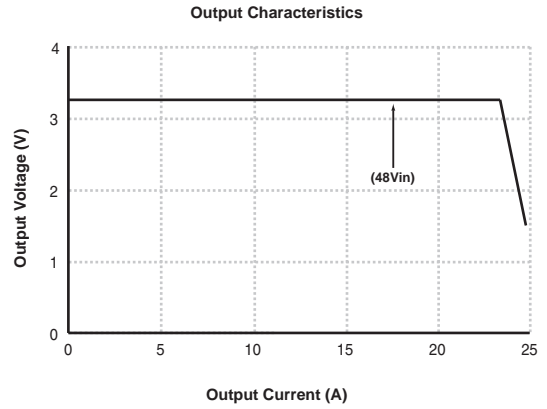
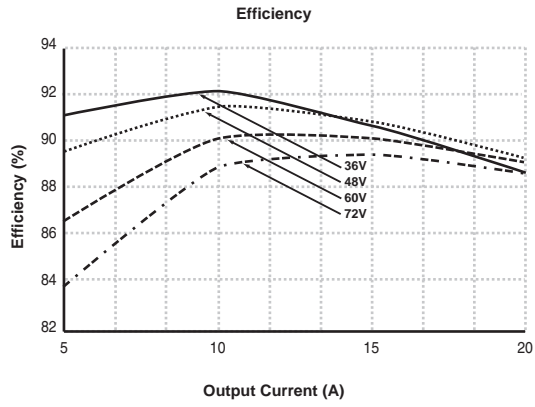

PKM 4510 PI (50W)

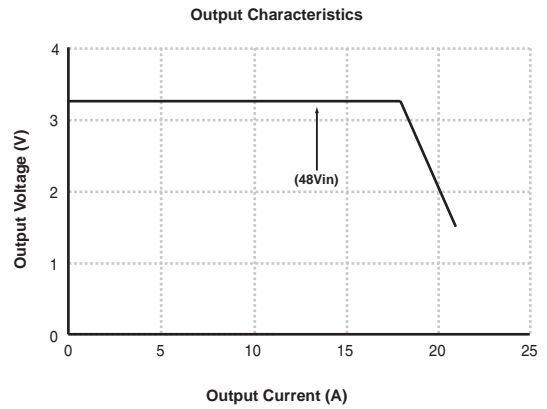
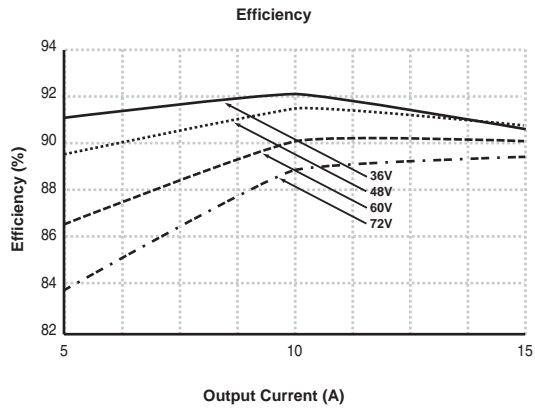

PKM 4111 PI (100W)

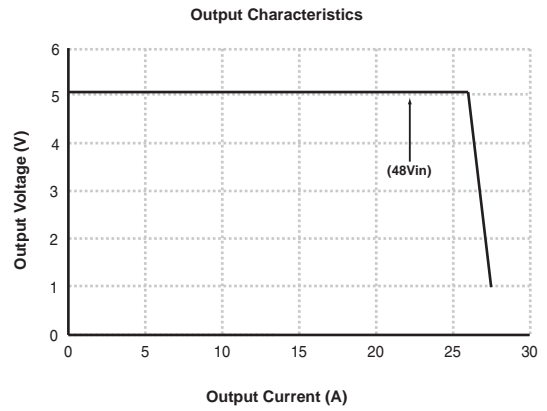
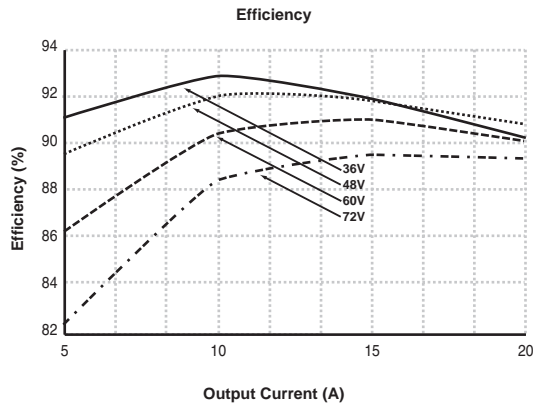

PKM 4711 PI (75W)

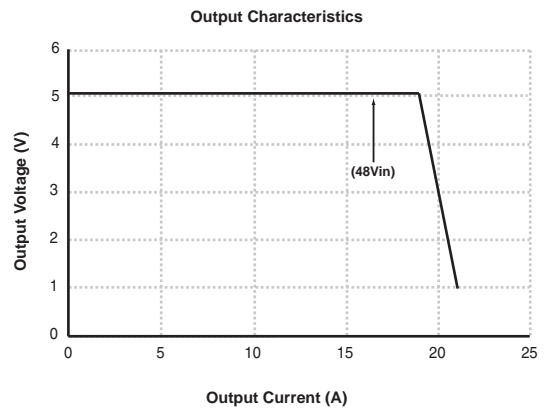
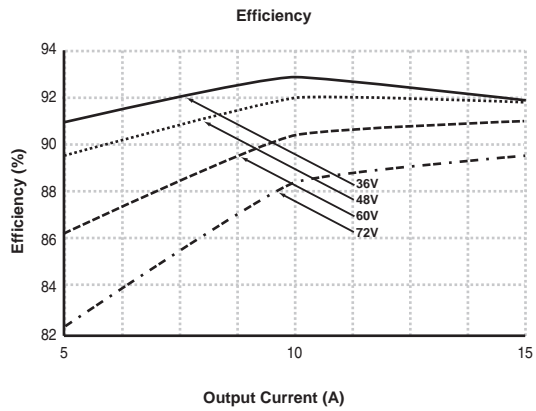

EMC Specifications

The PKM power module is mounted on a double sided printed circuit board PCB with groundplane during EMC measurements. The fundamental switching frequency is 150 kHz @ $I_O = I_{Omax}$.

Conducted EMI

Input terminal value with 100µF capacitor (typ) and additional PI filter.

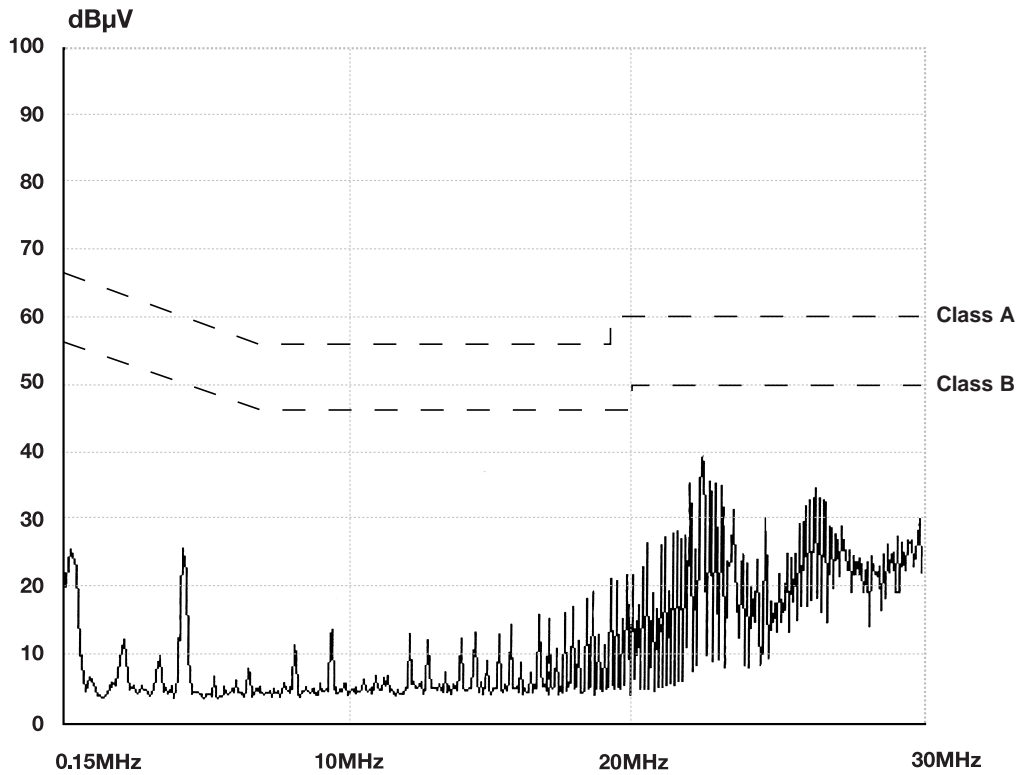

External Filter (class B)

Required external input filter in order to meet class B in EN 55022, CISPR 22 and FCC part 15J.

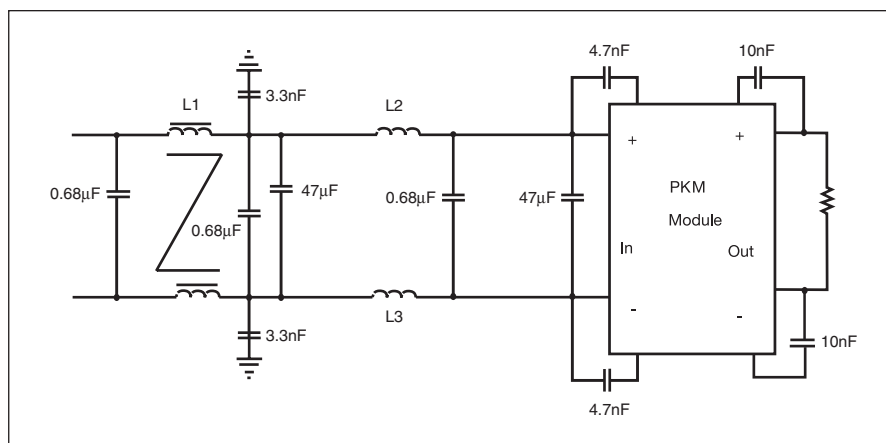

L1: 450µH TDK TF1028S-451Y3R-01
 L2 & L3: 22µH Coilcraft D05ø22P-23

*The baseplate is floated.

Operating Information

Input Voltage

The input voltage range 36...75V meets the requirements in the European Telecom Standard ETS 300 132-2 for normal input voltage range in -48V and -60V DC power systems, -40.5...-57.0V and -50.0...-72.0V respectively. At input voltages exceeding 75V, the power loss will be higher than at normal input voltage and T_C must be limited to absolute max +100° C. The absolute max continuous input voltage is 80V DC.

Remote Control (RC)

The PKM 4000 series DC/DC power modules have two remote on/off options available. Negative logic remote on/off is the standard option orderable without a suffix added to the part number. Negative logic remote on/off turns the module off during a logic high voltage on the on/off pin, and on during a logic low state. Positive logic remote on/off is orderable by adding the suffix "P" to the end of the part number. Positive logic remote on/off turns the module on during a logic high and off during a logic low state.

The RC pin can be wired directly to -In, to allow the module to power up automatically without the need for control signals.

A mechanical switch or an open collector transistor or FET can be used to drive the RC inputs. The device must be capable of sinking up to 1mA at a low level voltage of 1.0V, maximum of 15V dc, for the primary RC.

Standard Remote Control		Optional Remote Control (P)	
RC (primary)	Power module	RC (primary)	Power module
Low	ON	Low	OFF
Open/High	OFF	Open/High	ON

Remote Sense

All PKM 4000 series DC/DC power modules have remote sense that can be used to compensate for moderate amounts of resistance in the distribution system and allow for voltage regulation at the load or other selected point. The remote sense lines will carry very little current and do not need a large cross sectional area. However, the sense lines on a PCB should be located close to a ground trace or ground plane. In a discrete wiring situation, the usage of twisted pair wires or other technique for reducing noise susceptibility is recommended.

The power module will compensate for up to 0.5V voltage drop between the sense voltage and the voltage at the power module output pins. The output voltage and the remote sense voltage offset must be less than the minimum overvoltage trip point.

Current Limiting

General Characteristics

All PKM 4000 series DC/DC power modules include current limiting circuitry that makes them able to withstand continuous overloads or short circuit conditions on the output. The output voltage will decrease toward zero for heavy overloads.

The power module will resume normal operation after removal of the overload. The load distribution system should be designed to carry the maximum short circuit output current specified.

Over Voltage Protection (OVP)

All PKM 4000 DC/DC power modules have latching output overvoltage protection. In the event of an overvoltage condition, the power module will shut down. The power module can be restarted by cycling the input voltage.

Turn-(on/off) Input Voltage ($V_{i,on}/V_{i,off}$)

The power module monitors the input voltage and will turn on and turn off at predetermined levels. See Input Table on page 2.

Output Voltage Adjust (Trim) Voltage Trimming

All PKM 4000 series DC/DC power modules have an Output Voltage Adjust pin. This pin can be used to adjust the output voltage above or below V_{Oj} . When increasing the output voltage, the voltage at the output pins (including any remote sensing offset) must be kept below the overvoltage trip point. Also note that at elevated output voltages the maximum power rating of the module remains the same, and the output current capability will decrease correspondingly. These modules trim exactly like the other major competitors quarter-brick modules.

To decrease V_O connect Radj from - SEN to Trim

To increase V_O connect Radj from + SEN to Trim

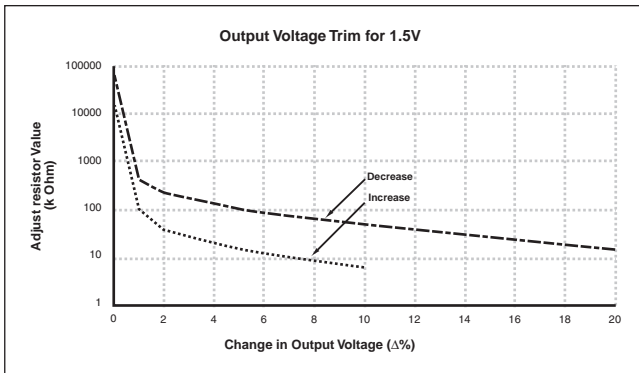

Decrease: $R_{adj} = 5.11 \left(\frac{100}{\Delta\%} - 2 \right) k\Omega$

Increase: $R_{adj} = 5.11 \left[\frac{V_o (100 + \Delta\%) - (100 + 2\Delta\%)}{1.225\Delta\%} \right] k\Omega$

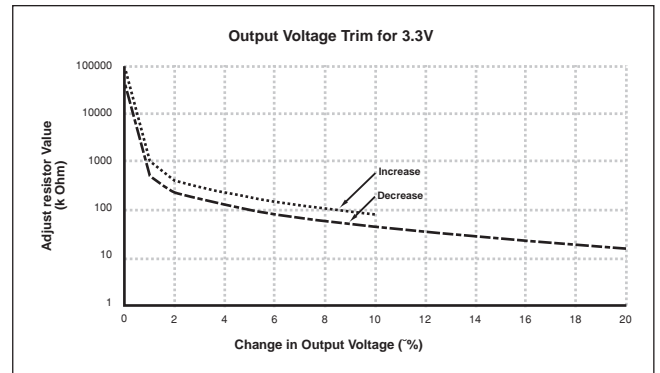

Decrease: $R_{adj} = 5.11 \left(\frac{100}{\Delta\%} - 2 \right) k\Omega$

Increase: $R_{adj} = 5.11 \left[\frac{V_o (100 + \Delta\%) - (100 + 2\Delta\%)}{1.225\Delta\%} \right] k\Omega$

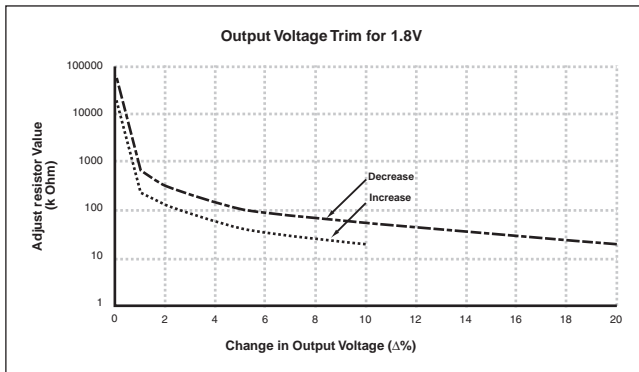

Decrease: $R_{adj} = 5.11 \left(\frac{100}{\Delta\%} - 2 \right) k\Omega$

Increase: $R_{adj} = 5.11 \left[\frac{V_o (100 + \Delta\%) - (100 + 2\Delta\%)}{1.225\Delta\%} \right] k\Omega$

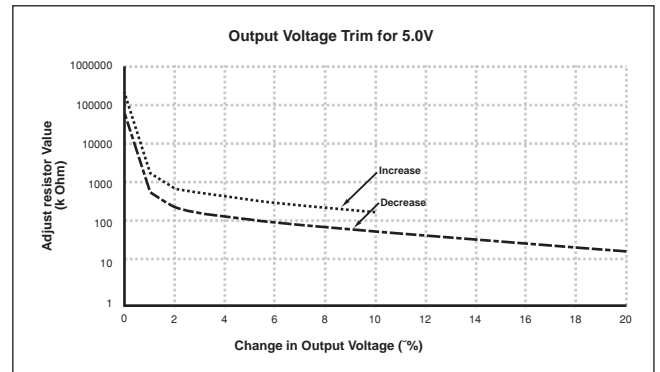

Decrease: $R_{adj} = 5.11 \left(\frac{100}{\Delta\%} - 2 \right) k\Omega$

Increase: $R_{adj} = 5.11 \left[\frac{V_o (100 + \Delta\%) - (100 + 2\Delta\%)}{1.225\Delta\%} \right] k\Omega$

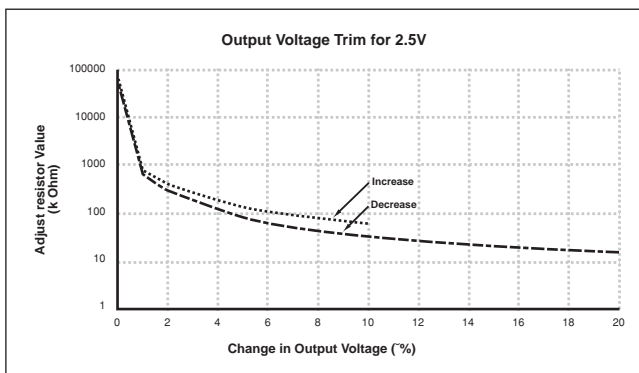

Decrease: $R_{adj} = 5.11 \left(\frac{100}{\Delta\%} - 2 \right) k\Omega$

Increase: $R_{adj} = 5.11 \left[\frac{V_o (100 + \Delta\%) - (100 + 2\Delta\%)}{1.225\Delta\%} \right] k\Omega$

Product Program

V_I	V_O/I_O	P_{Omax}	Ordering Number
48/60 V	1.5V/20A	30W	PKM 4318 PIOA
48/60 V	1.5V/15A	22.5W	PKM 4218 PIOA
48/60 V	1.8V/20A	36W	PKM 4318 PI
48/60 V	1.8V/15A	27W	PKM 4218 PI
48/60 V	2.5V/20A	50W	PKM 4519 PI
48/60 V	2.5V/15A	37.5W	PKM 4319 PI
48/60 V	3.3V/20A	66W	PKM 4610 PI
48/60 V	3.3V/15A	50W	PKM 4510 PI
48/60 V	5V/20A	100W	PKM 4111 PI
48/60 V	5V/15A	75W	PKM 4711 PI

The PKM DC/DC power module may be ordered with the different options listed in the Product Options table.

Product Options

Option	Suffix	Example
Negative remote on/off logic	-	<i>PKM 4610 PI</i>
Positive remote on/off logic	P	<i>PKM 4610 PIP</i>
Lead length of 0.145" ± 0.010"	LA	<i>PKM 4610 PILA</i>

Information given in this data sheet is believed to be accurate and reliable. No responsibility is assumed for the consequences of its use for any infringement of patents or other rights of third parties that may result from its use. No license is granted by implication or otherwise under any patent or patent rights of Ericsson Inc., Microelectronics. These products are sold only according to Ericsson Inc., Microelectronics' general conditions of sale, unless otherwise confirmed in writing. Specifications subject to change without notice.

Ericsson Inc.
 Microelectronics
 1700 International Pkwy., Suite 200
 Richardson, Texas 75081
 Phone: 877-ERICMIC
www.ericsson.com/microelectronics
 For sales contacts, please refer to our website
 or call: 877-374-2642 or fax: 972-583-8355

**The latest and most complete
 information can be found on our website!**

Preliminary Data Sheet

AE/LZT 108 4913 R2
 © Ericsson Inc., Microelectronics, May 2001